



Martin O'Malley, Governor
Anthony G. Brown, Lt. Governor
John R. Griffin, Secretary
Joseph P. Gill, Deputy Secretary

DRAFT I

Quality Assurance Project Plan

for the
Maryland Department of Natural Resources
Chesapeake Bay
Water Quality Monitoring Program-
Chemical and Physical Properties Component
for the period July 1, 2010 - June 30, 2011

May 27, 2010

Tawes State Office Building • 580 Taylor Avenue • Annapolis, Maryland 21401
410.260.8DNR or toll free in Maryland 877.620.8DNR • TTY users call via Maryland Relay

**Quality Assurance Project Plan
for the
Maryland Department of Natural Resources
Chesapeake Bay Water Quality Monitoring Program -
Chemical and Physical Properties Component
for the period July 1, 2010 - June 30, 2011**

Prepared by:
Ben Cole and Thomas Parham
Tidewater Ecosystem Assessment
Maryland Department of Natural Resources
Tawes Building, D-2
580 Taylor Avenue
Annapolis, MD 21401

Website Address:
www.dnr.state.md.us

Toll Free in Maryland:
1-877-620-8DNR, ext: 8630
Out of state call: 410-260-8630
TTY users call via the MD Relay:
711 (within MD)
Out of state call: 1-800-735-2258

© 2010 Maryland Department of Natural Resources

The facilities and services of the Maryland Department of Natural Resources are available to all without regard to race, color, religion, sex, sexual orientation, age, national origin or physical or mental disability. This document is available in alternative format upon request from a qualified individual.

Martin O'Malley, Governor

Anthony G. Brown, Lt. Governor



Printed on Recycled Paper

**Quality Assurance Project Plan
for the
Maryland Department of Natural Resources
Chesapeake Bay
Water Quality Monitoring Program—
Chemical and Physical Properties Component
for the period July 1, 2010 - June 30, 2011**

May 27, 2010

Carl Zimmerman, Director of Analytical Services/Quality Assurance Officer
Chesapeake Biological Laboratory
University of Maryland, Center for Environmental Science

Thomas Parham, Director/Principal Investigator
Tidewater Ecosystem Assessment Division
Maryland Department of Natural Resources

Bruce Michael, Director/Quality Assurance Officer
Resource Assessment Service
Maryland Department of Natural Resources

Rich Batiuk, U.S. EPA CBPO QA Officer

Peter Tango, U.S. EPA CBPO Project Officer

PREFACE

This document is intended to describe in detail the activities conducted under the Chemical and Physical Properties Component of the Maryland Department of Natural Resources Chesapeake Bay Water Quality Monitoring Program. This is a coordinated program consisting of several components conducted in a similar manner for identical purposes in both the tributaries and mainstem of Maryland's Chesapeake Bay. This program is funded through the Maryland Department of Natural Resources and the U.S. Environmental Protection Agency.

LIST OF PREPARERS

Editors:

Ben Cole, Natural Resource Biologist, Tidewater Ecosystem Assessment, Resource Assessment Service, Maryland Department of Natural Resources, 580 Taylor Avenue, D-2, Annapolis, Maryland 21401.

Bruce Michael, Quality Assurance Officer, Resource Assessment Service, Maryland Department of Natural Resources, 580 Taylor Avenue, D-2, Annapolis, Maryland 21401.

Contributors:

Sally Bowen, Program Chief, Monitoring Field Office, Resource Assessment Service, Maryland Department of Natural Resources, 416 Chinquapin Round Road, Annapolis, Maryland 21401.

Greg Gruber, Resource Assessment Service, Maryland Department of Natural Resources, 416 Chinquapin Round Road, Annapolis, Maryland 21401.

Kristen Heyer, Resource Assessment Service, Maryland Department of Natural Resources, 416 Chinquapin Round Road, Annapolis, Maryland 21401.

Renee Karrh, Tidewater Ecosystem Assessment, Resource Assessment Service, Maryland Department of Natural Resources, 580 Taylor Avenue, D-2, Annapolis, Maryland 21401.

Nancy Kaumeyer, Chesapeake Biological Laboratory, University of Maryland, Center for Environmental Science, Solomons, Maryland, 20688-0038.

Thomas Parham, Principal Investigator, Tidewater Ecosystem Assessment, Resource Assessment Service, Maryland Department of Natural Resources, 580 Taylor Avenue, D-2, Annapolis, Maryland 21401.

Carl Zimmerman, Director of Analytical Services/Quality Assurance Officer, Chesapeake Biological Laboratory, University of Maryland, Center for Environmental Science, Solomons, Maryland, 20688-0038.

TABLE OF CONTENTS

PREFACE	i
LIST OF PREPARERS	ii
LIST OF FIGURES	iv
LIST OF TABLES	iv
ACRONYMS AND ABBREVIATIONS	v
1. INTRODUCTION	1
2. MEASURED PARAMETERS	12
3. FIELD MEASUREMENTS AND SAMPLING	18
4. LABORATORY ANALYSIS	19
5. DATA MANAGEMENT, VERIFICATION AND DOCUMENTATION	19
7. DATA ANALYSIS AND REPORTING	25
8. PROJECT ORGANIZATION AND RESPONSIBILITY	26
9. PROCEDURAL CHANGE PROTOCOL	27
10. LOG OF SIGNIFIGANT CHANGES	27
11. REFERENCES	28

APPENDICES

Appendix I.	Water Column Sampling and Sample Processing Procedures
Appendix II.	Field, Laboratory, and Chlorophyll Sheets, Documentation and Procedures
Appendix III.	Cross Reference Sheet, Documentation and Procedures
Appendix IV.	Cruise Report/Quarterly Progress Report, Documentation and Procedures
Appendix V.	Field Instrument Quality Assurance/Quality Control (Includes Equipment Calibration Log and Instrument Maintenance/Repair Log)
Appendix VI.	Field Procedures Quality Assurance/Quality Control
Appendix VII.	University of Maryland, Chesapeake Biological Laboratory Nutrient Analytical Services Laboratory Standard Operating Procedures and Methods
Appendix VIII.	Split Sample Program and Split Sample Custody Log
Appendix IX.	Data Status Form, Documentation and Procedures
Appendix X.	Codes for Water Quality Sheets
Appendix XI.	Data Entry Request Form, Documentation and Procedures
Appendix XII.	Sample Verification Reports and Plots and Edit Form
Appendix XIII	Chesapeake Bay Monitoring Program Procedure Modification Tracking Form
Appendix XIV	Chesapeake Bay Monitoring Program Log of Significant Changes

LIST OF FIGURES

Figure 1 Map of Maryland Department of Natural Resources Chesapeake Bay Mainstem and Bay Tributary Water Quality Monitoring Stations. Red squares indicate the stations monitored since 1985 (or earlier). Orange circles indicate stations monitored since 1998, originally as part of Maryland's Pfiesteria sampling and added to the routine monitoring program.	5
Figure 2 Data Management Flow Chart.....	21
Figure 3 Data Tracking Flow Chart.....	22

LIST OF TABLES

Table 1 Mainstem and Tributary sample locations and descriptions.....	6
Table 2 Water Column Parameters, Detection Limits, Methods References, and Holding Times and Conditions.	14
Table 3 Minimum Detection Limits for Field Measurements	25

ACRONYMS AND ABBREVIATIONS

AA - autoanalyzer
Ag - silver
AgCl - silver chloride
AMQAW - Analytical Methods and Quality Assurance Workgroup (a workgroup of the Chesapeake Bay Program's Monitoring Subcommittee)
AP - above pycnocline
ARS - Analysis Request Sheet
Au - gold
B - bottom sample
BP - below pycnocline OR barometric pressure
C - carbon
CBP - EPA's Chesapeake Bay Program
CBPO - EPA's Chesapeake Bay Program Office
CBL - University of Maryland's Chesapeake Biological Laboratory
CIMS - Chesapeake Information Management System
cm - centimeter
CMC - chlorophyll measurement computer
CSSP - Coordinated Split Sample Program
DHMH - Maryland Department of Health and Mental Hygiene
DAWG - Data Analysis Workgroup
DI - de-ionized
DNR - Maryland Department of Natural Resources
DO - dissolved oxygen
DOC - dissolved organic carbon
EPA - U.S. Environmental Protection Agency
g - gram
H₂O - dihydrogen oxide (water)
H₂S - hydrogen sulfide
HCL - hydrochloric acid
Hg - mercury
L - liter
m - meter
MASC - Chesapeake Bay Program Monitoring and Analysis Subcommittee
MDE - Maryland Department of the Environment
MgCO₃ - magnesium carbonate
min. - minute
mg - milligram
ml - milliliter
mm - millimeter
MSU - Morgan State University
N - nitrogen
NaHCO₃ - sodium bicarbonate

NIST - National Institute of Standards and Technology
nm - nanometer
no. - number
NO₂ - nitrite
NO₃ - nitrate
NPS - National Park Service
NTU - Nephelometric Turbidity Units
OD - optical density
P - phosphorus
PC - particulate carbon OR
PC - personal computer
PN - particulate nitrogen
PO₄ - phosphate
PP - particulate phosphorus
ppt - parts per thousand
QAO -Quality Assurance Officer (unless otherwise noted, this refers to the DNR QAO)
QAPP - Quality Assurance Project Plan
RP - replicate
R/V - research vessel
S - surface sample
SAS - Statistic Analysis System
SIF - silica
TMAW - Tidal Monitoring and Analysis Workgroup
TDN - total dissolved nitrogen
TDP - total dissolved phosphorus
trib - Bay Tributary
TSS - total suspended solids
USDI - U.S. Department of the Interior
USGS - U.S. Geological Survey
VSS - Volatile Suspended Solids
YSI - Yellow Springs Instruments

°C - degrees Celsius

1. INTRODUCTION

1.1 Background

At the completion of the U. S. Environmental Protection Agency's (EPA's) \$27 million study of Chesapeake Bay, the Agency published a document entitled [*Chesapeake Bay: A Framework for Action*](#) (EPA 1983). This report strongly recommended a long-term water quality monitoring program to serve the Bay's management community by accurately describing the current state of the Bay mainstem and tidal tributaries (baseline or 'status') and detecting long-term changes (trends) resulting from human activities. Management strategies at that time were hindered by the lack of precise information about the Bay and its response to increasing or decreasing pollution.

Managers, scientists, and statisticians recognized that to establish baseline conditions and then begin to identify trends would require a multi-year effort on the order of a decade or more. Long-term data was needed to overcome the natural year-to-year variability that can obscure changes due to human activities. As the EPA study drew to a close, scientists and managers convened in workshops to formulate plans on several topics, including water quality monitoring. The monitoring workshop recommendations for chemical and physical measurements were published in the appendices of *Chesapeake Bay: A Framework for Action*. The appendices described the chemical/physical monitoring plan in terms of station locations, parameters to be measured, and sampling frequency.

This Quality Assurance Project Plan (QAPP) describes Maryland's implementation of the coordinated Maryland, Virginia, and EPA Chesapeake Bay monitoring program as outlined in *Chesapeake Bay: A Framework for Action* (EPA 1983). This part of Maryland's Chesapeake Bay Water Quality Monitoring Program is known as the "Chemical and Physical Properties Component" and covers monitoring in the Maryland portion of the mainstem as well as the tidal tributaries. Other components of the water quality program measure biological and process oriented indicators of water quality; those components are not described in this document.

1.2 Objectives

The Maryland Department of Natural Resources (DNR) uses the data generated by means of the procedures in this QAPP to meet the five water quality monitoring objectives of the Chesapeake Bay Water Quality Monitoring Program:

1. Characterize the present state of the Bay mainstem and its tributaries (baseline), including spatial and seasonal variation, using key water quality indicators.
2. Determine long-term trends or changes in key water quality indicators in relation to pollution control programs.
3. Integrate the information collected in all components of the monitoring program to gain a more comprehensive understanding of water quality processes and the relationship between water quality and living resources.
4. Track the progress of management strategies to reduce nutrient pollution.

5. Provide data for the Chesapeake Bay watershed and ecological models.

1.3 Sampling Design and Data Quality Objectives

1.3.1 *Parameters*

The scope of work for this component of the coordinated Chesapeake Bay Water Quality Monitoring Program includes the measurement of chemical and physical parameters in the water column. Parameters such as nutrients, total suspended solids, chlorophyll *a*, dissolved oxygen and water transparency were selected to (1) provide information on eutrophication trends; (2) calibrate Bay water quality models; and, (3) correlate living resources data to water quality data. Other parameters such as salinity and temperature are necessary to provide a more rigorous interpretation of these key water quality indicators. The same parameters are collected in the mainstem, large tributaries (Potomac and Patuxent Rivers), and minor tributaries except for dissolved organic carbon and silica. Dissolved organic carbon is no longer collected in the mainstem with one exception. Due to logistical considerations, the Potomac tributary sampling station LE2.3 is sampled during Mainstem cruises.

Silica (SIF) samples will be collected monthly, from the surface and above pycnocline layers, January through June 2010 at the plankton sampling stations (CB1.1, CB2.2, CB3.3C, CB4.3C, CB5.2, TF2.3, RET2.2, LE2.2, TF1.5, TF1.7, LE1.1, ET5.1 and WT5.1). Silica samples will not be collected at any stations July through December 2010. Silica will be sampled January through June 2011.

(A complete list of parameters measured and detection limits is provided in Section 2, Table 2.)

The information gained from analyzing the entire suite of parameters allows managers to determine whether or not water quality goals established for living resources have been met and aids managers in establishing programs to control point and non-point sources of pollutants to the Bay.

1.3.2 *Spatial Aspects*

A total of 21 mainstem stations and 70 tributary stations are included in Maryland's Chemical and Physical Properties Component of the Chesapeake Bay Water Quality Monitoring Program (Figure 1 and Table 1). Station locations were selected to provide data that would satisfy the five objectives of the program stated above for the major tributaries and the mainstem. The following describes the four sets of criteria used to determine the general location for stations:

Primary Selection Criteria. During the initial phases of the Bay Program, EPA developed a segmentation/characterization scheme of the Chesapeake Bay and its tributaries published in the appendices of [Chesapeake Bay: A Profile of Environmental Change](#) (EPA 1983). This scheme provided guidance for station selection by delimiting different regions (based on circulation, salinity, and geomorphology) such as tidal fresh, oligohaline, and mesohaline. Several primary goals were considered in selecting station locations. Selecting a suite of stations such that each segment would be characterized was the foremost goal. Another important criterion was the location of boundaries between segments (e.g. mouths of major tributaries and the upper boundary of the deep trough region). Boundary areas are important because of their influence on a particular region of the Bay or their relevance to problem areas. In large systems, i.e., the Potomac and Patuxent Rivers and the mainstem, multiple stations were located in some of the major salinity zones due to the large size of these systems and their importance to

management concerns. Existing water quality monitoring stations in the Potomac River and Patuxent River were incorporated into the Bay-wide network because of the wealth of historical data at these stations.

Secondary Selection Criteria. Locations of documented water quality problems in certain areas served as secondary considerations in locating stations. For example, additional stations were included in the lateral dimension of the deep trough region of the mainstem to characterize the deepwater anoxic/hypoxic conditions. Another example was the siting of stations in some of the smaller tributary segments in areas that were profoundly impacted by point-sources. Stations sited in these affected areas provide excellent opportunities to assess the effectiveness of control strategies targeted at reducing these major impacts.

Tertiary Selection Criteria. Another consideration in siting stations was their proximity to important living resource habitats and living resource monitoring sites. This criterion was accommodated only if the primary and secondary criteria above were also satisfied. These stations provide valuable data to correlate with living resources monitoring and thereby help to resolve the link between water quality and recent living resource declines.

Final Selection Criteria. The fourth and final consideration in locating stations was the historical record of water quality sampling. If a station already had a record of previous water quality data *and* it satisfied the three sets of criteria stated above, the station was adopted for this program to permit comparisons with historical data bases. In selecting stations for the Patuxent and Potomac Rivers, this criterion was elevated to a primary criterion. Additional historical stations in the Patuxent and Potomac were adopted into the Chesapeake Bay Program sampling program even if they did not fulfill all three sets of criteria above, because of the very long-term data sets associated with these stations.

Establishing Mid-Channel and Near-shore Stations. In both the mainstem and tributaries, stations were selected in mid-channel locations to provide a characterization of the entire water column in that region and to capture the lowered oxygen levels in the deeper layers. The water column at mid-channel also provides a more stable environment than shallow locations, which are subject to ephemeral influences such as wind-driven resuspension of bottom sediments and periodic advection of deep-channel water masses; thus, mid-channel stations provide data with less short-term variability. Minimizing short-term variability is desirable in order to detect long-term trends. As mentioned above, in the mainstem's deep trough region, lateral stations were established to track a particular concern. Two near-shore stations were located beside each of the four mid-channel stations. These near-shore stations were located at the 30-foot depth contour or at the boundary of adjacent embayments. Stations also were located at the boundary between the mainstem and the two largest tributaries in Maryland—the Susquehanna and Potomac Rivers—to assess the water quality interactions occurring across these critical regions.

Updating the Segmentation Scheme. During 1997, a workgroup was established to re-evaluate the segmentation scheme using the data generated by the program from 1985-1996. DNR uses the current segmentation scheme established by the EPA Chesapeake Bay Program (CBP) to classify stations and analyze data (see Table 1). Under the new segmentation scheme, four segments (CHOTF, NANO, HNGMH, and POCOH) do not include long-term stations. The [Chesapeake Bay Program, Analytical Segmentation Scheme, Revisions, Decisions and Rationales, 1983-2003, 2005 Addendum](#), December, 2005 and the Chesapeake Bay Program Monitoring and Analysis Subcommittee Tidal Monitoring and Analysis Workgroup October 2004 document: [Chesapeake Bay Program, Analytical Segmentation](#)

[Scheme, Revisions, Decisions and Rationales 1983-2003](#) provide detailed descriptions of the CBP's segmentation and its development.

1.3.3 *Temporal Aspects*

Water column samples are collected at least once a month at most stations, for a minimum of twelve samplings per year. In the Chesapeake mainstem, sampling will be conducted twice monthly in June, and August of 2010, and once monthly during the remaining months, for a total of fourteen samplings in the period of July 1, 2010 - June 30, 2011. However, at eastern and western transect mainstem stations, samples will not be collected from November through February, resulting in only ten samplings a year. On the Potomac and Patuxent and smaller tributaries, twelve samplings will be conducted per year. The frequencies of sampling during the 2010-2011 are less than the frequencies of sampling in 2009-2010. See Appendix XIV, Log of Significant Changes, for details. Sampling frequency for each station is shown in Table 1. This frequency of sampling permits assessments to be made on a seasonal basis, which is a time scale consistent with many of the natural intra-annual changes in water quality indicators.

Because of the relatively small sample sizes resulting from only two to four sampling events per season, it is more difficult to detect seasonal trends in data from stations sampled only once per month. Nevertheless, with a long-term program, sufficient data can be collected to determine seasonal patterns in most water quality parameters at each site with high statistical confidence.

In 1994, *An Assessment of the Power and Robustness of the Chesapeake Bay Program Water Quality Monitoring Program: Phase II - Refinement Evaluations* (Alden et al. 1994) concluded that although the 12-cruise scenario was less statistically powerful than the 20-cruise scenario, the 12-cruise scenario was none-the-less adequate for the Chesapeake Bay Mainstem monitoring to capture long-term annual trends; the Chesapeake Bay Program decided on a 14-cruise scenario for the monitoring program. Based on these recommendations, in January 1996, Maryland dropped its Chesapeake Bay mainstem January and February cruises and reduced its cruises in March, June, September, and October to once per month. Experience has since shown that this reduced sampling frequency can miss some extremely important climatic and biological events (e.g., the 100-year flood of January 1996). Therefore, CBP restored funding in Maryland for its January and February monitoring cruises beginning in January 1999, for a total of 16 cruises. When funding was available, a second June mainstem cruise was also added to the sample schedule to better characterize the onset of summer hypoxia/anoxia conditions in deep water.

In November 2009, EPA funding reductions resulted in a resumption of a fourteen-cruise scenario in future years. The Mainstem is sampled monthly and there is a second cruise in both June and August.

Beginning in January 2010, due to further funding reductions, fourteen Patuxent River stations will be sampled twelve times instead of twenty times per year. The twelve Potomac River stations will be sampled twelve instead of twenty times per year. Two stations on the Chester River, two stations on the Choptank River and one station on the Back River will be sampled twelve times per year instead of sixteen times per year.

This level of sampling frequency is judged to be the optimal allocation of effort given the limited level of resources. It provides for wide spatial coverage of almost every major tributary in Maryland as well as for information on the major systems that are the focus of major management strategies.

Figure 1 Map of Maryland Department of Natural Resources Chesapeake Bay Mainstem and Bay Tributary Water Quality Monitoring Stations. Red squares indicate the stations monitored since 1985 (or earlier). Orange circles indicate stations monitored since 1998, originally as part of Maryland's Pfiesteria sampling and added to the routine monitoring program in 2003.

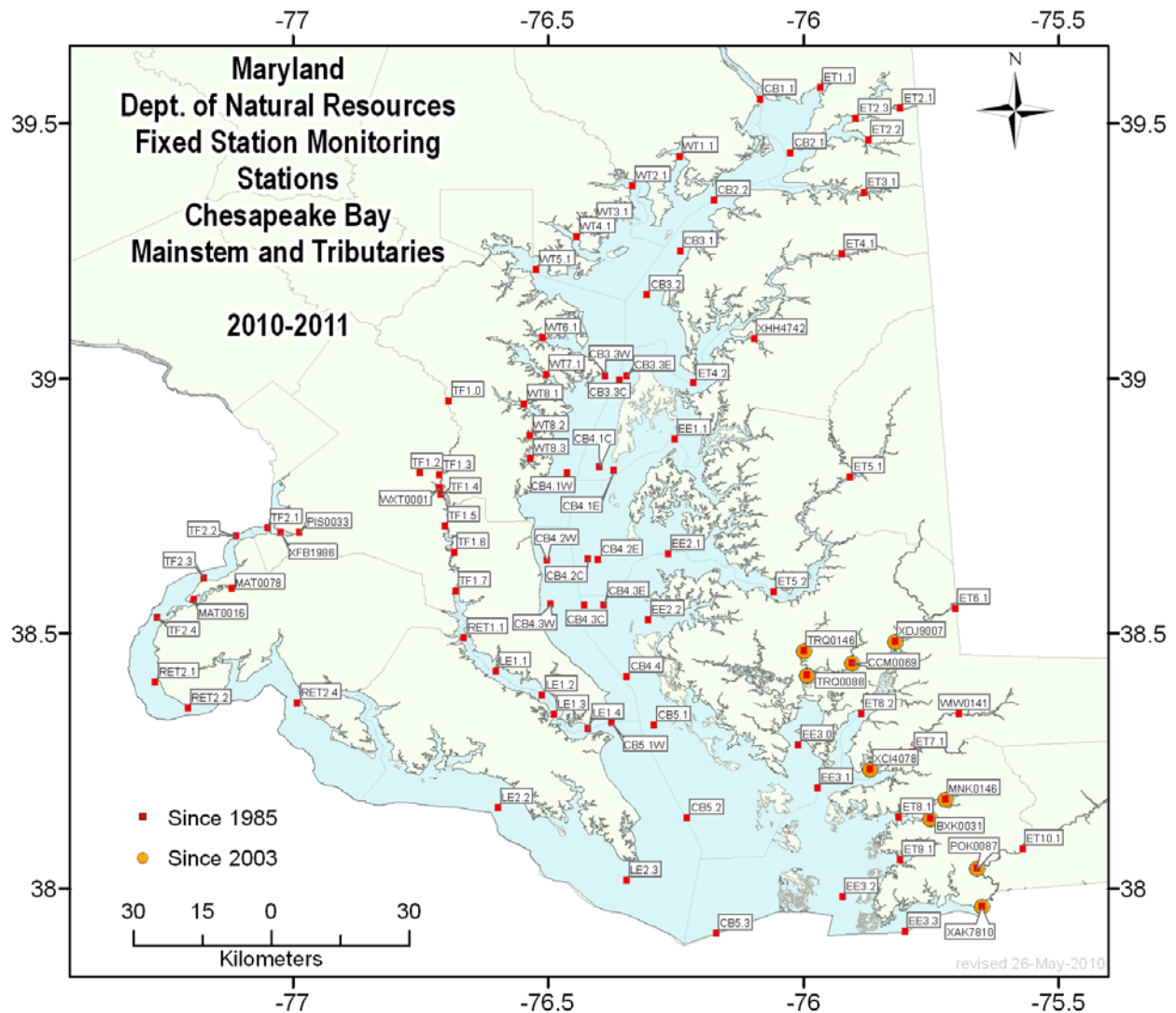

Table 1 Mainstem and Tributary sample locations and descriptions.

Component	Station Name	Location/Depth	Ches. Bay Program Segment	Sampling Coordination	Historical Station names	Latitude/ Longitude (NAD83 DMS)	Annual Sample Freq. x No. Of Depths
Mainstem	CB1.1	Mouth of Susquehanna River (700 yds from abandoned Light House on Hdg 040, 400 yds NNW of N 18 on line with N 20); 5.7 m.	CBTF1	PAR; VSS; plankton	OEP XKH3147	39 32.8762738 76 05.0886767	14x2
Mainstem	CB2.1	SW of Turkey Point (1 nm from Turkey Pt Light on Hdg 240, 800 yds SE of RG A); 6.1m.	CBTF1	PAR DNR Phytoplankton (live), plankton	CBI 927SS OEP XJH6680	39 26.4894865 76 01.5594740	14x2
Mainstem	CB2.2	W of Still Pond (500 yds W of G 49, 1.75 nm S of Taylor Island Pt off Still Pond); 11.5m.	CB2OH	PAR; VSS; plankton	CBI 92OU, 921W, 922Y OEP XJG0999	39 20.9239078 76 10.5472401	14x4
Mainstem	CB3.1	SE of Gunpowder Neck (2.1nm from south tip of Pooles Island Hdg 146, halfway between buoys 31 and 33); 11.2 m.	CB2OH	PAR	CBI 913R, 914S	39 14.9699926 76 14.4301009	14x4
Mainstem	CB3.2	NW of Swan Pt (400 yds NW of Tolchester Channel 13, 1.9 nm from Swam Point on Hdg 328); 11.5 m.	CB3MH	PAR	CBI 909 OEP XHG4953 OEP XHG9915	39 09.8215856 76 18.3788588	14x4
Mainstem	CB3.3C	N of Bay Bridge (1.6 nm, from Sandy Pt Light on Hdg 145, 0.4 nm NNE of bridge at edge of cable cross); 20.7 m.	CB3MH	PAR, VSS, DNR Phytoplankton (live), plankton	CBI 858C, 859B OEP XFH1373 OEP XGF9784 EPA D2	38 59.7574462 76 21.5802267	14x4
Mainstem	CB3.3E	NE of Bay Bridge (1.9nm from Sandy Pt Light on Hdg 260, 1 nm NNE of Bridge in East Channel); 8.2 m.	CB3MH	PAR	CBI 859A OEP XFH0293 EPA D3	39 00.2468723 76 20.7101544	10x2
Mainstem	CB3.3W	NW of Bay Bridge (0.7 nm from Sandy Pt Light on Hdg 210, 0.7 nm SE Sandy Pt Water Tank); 9.1m.	CB3MH	PAR	CBI859D OEP XHF0366 EPA D1	39 00.2772786 76 23.2858222	10x2
Mainstem	CB4.1C	SW of Kent Pt (0.5nm from Bloody Pt Light just West of line from Bloody Pt to G 83); 31.0 m.	CM4MH	PAR	CBI 845G, 848E OEP XFF9178 EPA '83DO	38 49.5557571 76 23.9670797	14x4
Mainstem	CB4.1E	S of Kent Pt (1.4 nm SE Bloody Pt Light, 300 yds SW buoy 1 for Eastern Bay); 23.7 m.	CB4MH	PAR	CBI 851N EPA '83DO OEP XFF9178	38 49.0856140 76 22.2862891	10x4
Mainstem	CB4.1W	SE of Horseshoe Pt (3.5nm from Bloody Pt. Light on Hdg 260, 1.6 nm E of Franklin Manor); 9.1 m.	CB4MH	PAR, DNR Phytoplankton (live)	CBI 848G, H, I OEP XFF1844 OEP XFF8922	38 48.8987701 76 27.7630455	10x2
Mainstem	CB4.2C	SW of Tilghman Island (2nm from Sharps Island Light on Hdg 290, 300 yds NE of CR buoy) 26.2 m.	CB4MH	PAR	EPA '83DO OEP XEF8648	38 38.7710773 76 25.2758161	14x4
Mainstem	CB4.2E	SW of Tilghman Island (1.3nm from Sharps Island Light on Hdg 305, 0.9 nm E of CR buoy); 9.1 m.	CB4MH	PAR	OEP XEF8859	38 38.6991249 76 24.0789313	10x2

Component	Station Name	Location/Depth	Ches. Bay Program Segment	Sampling Coordination	Historical Station names	Latitude/ Longitude (NAD83 DMS)	Annual Sample Freq. x No. Of Depths
Mainstem	CB4.2W	NW of Plum Pt (6nm from Sharps Island. Light on Hdg 280, 1.0 nm E of Camp Roosevelt); 9.1 m.	CB4MH	PAR	OEP XEF8699 EPA '83DO	38 38.6122822 76 30.1298742	10x2
Mainstem	CB4.3C	E of Dares Beach (0.5 nm W of R 78, 5.7 nm from Sharps Island Light, Hdg 220); 25.6 m.	CB4MH	PAR; VSS Plankton	OEP XEF3343	38 33.3031773 76 25.6765828	14x4
Mainstem	CB4.3E	Mouth of Choptank River (1.7 nm. East of R78, 5 nm. from Sharps Island Light on Hdg 195); 21.6 m.	CB4MH	PAR	OEP XEF3465	38 33.3743630 76 23.4728861	10x4
Mainstem	CB4.3W	E of Dares Beach (1nm. East of Dares Beach, 3nm. West of R78); 9.7 m.	CB4MH	PAR	CBI 834H, J OEP XEF3405	38 33.4368892 76 29.6411944	10x2
Mainstem	CB4.4	NE of Cove Pt (2.4 nm from Cove Pt on Hdg 055); 28.6 m.	CB4MH	PAR, Quarterly Split Sample Location	OEP XDF4693	38 24.8744293 76 20.7387902	14x4
Mainstem	CB5.1	E of Cedar Pt (1 nm. ENE of mid-channel buoy HI, 4nm. from Cedar Pt. on Hdg 070); 33.2 m.	CB5MH	PAR, DNR Phytoplankton (live)	CBI 818N, P CBI 819N, O OEP XCG9223	38 19.1218979 76 17.5286492	14x4
Mainstem	CB5.2	Mid Bay E of Pt No Point (3 nm. From Point No Point Light on Hdg 080); 29.0 m.	CB5MH	PAR; VSS, Plankton	Benthos #58 (Versar) OEP XBG8262	38 08.2229854 76 13.6720392	14x4
Mainstem	CB5.3	NE of Smith Point (2nm. from Smith Point Light toward on Hdg 020, intersect MD/VA line and transect from Smith Pt to Holland bar Light); 25.3 m.	CB5MH	PAR	USGS 37524807 USGS 6094200 OEP XAG4699	37 54.6067961 76 10.2821397	14x4
Patuxent	TF1.0	At bridge on US Rt. 50 (upstream side of bridge; USGS Gage No 59440); 3.0 m.	PAXTF		OEP PXT0603 USGS 01594440 EPA E	38 57.3343692 76 41.6465749	12x1
Patuxent	TF1.2	Midstream of Western Branch at Water Street crossing in Upper Marlboro, MD; 3.0 m.	WBRTF		OEP WXT0045	38 48.8580017 76 45.0520702	12x1
Patuxent	WXT0001	Western Brach from pier at Mt Calvert House in Upper Marlboro, 0.1 miles above mouth; 1.0 m.	WBRTF			38 47.1230110 76 42.8058027	12x1
Patuxent	TF1.3	Mid-channel from MD Rt. 4 bridge near Waysons Corner; 3.7 m.	PAXTF		OEP PXT0494 EPA E5,5	38 48.6550025 76 42.7364996	12x1
Patuxent	TF1.4	West Shore from main pier at Jackson Landing; just below confluence with Western Branch; 3.0 m.	PAXTF		OEP PXT0456 EPA E6A	38 46.3810259 76 42.5562188	12x1
Patuxent	TF1.5	Mid-channel at Nottingham, 11.1m.	PAXTF	VSS , DNR phytoplankton (live); plankton	OEP PXT0402 EPA E8	38 42.6070912 76 42.0878729	12x4
Patuxent	TF1.6	Mid-channel off the wharf at Lower Marlboro, 6.0 m.	PAXOH	plankton	OEP XED9490 EPA E9 J.H. 5945	38 39.5070054 76 41.0291236	12x3
Patuxent	TF1.7	Mid-channel on a transect heading of approx. 115 degrees from Jack's Creek; 3.1 m.	PAXOH	VSS, plankton	OEP XED4892 J.H. 5946	38 34.9264583 76 40.8603554	12x2

Component	Station Name	Location/Depth	Ches. Bay Program Segment	Sampling Coordination	Historical Station names	Latitude/ Longitude (NAD83 DMS)	Annual Sample. Freq. x No. Of Depths
Patuxent	RET1.1	Mid channel, 0.5 km ENE of Long Point, 11.1 m.	PAXMH	DNR phytoplankton (live); DNA probe	OEP XDE9401 EPA E14, 4 CB 1	38 29.4538477 76 39.8574145	12x4
Patuxent	LE1.1	Mid-channel SSW of Jack Bay sand-spit. NE of Sandgates; 12.5 m.	PAXMH	VSS, DNR phytoplankton (live), plankton, DNA probe,	OEP XDE5339 EPA E15	38 25.5208238 76 36.1058647	12x4
Patuxent	LE1.2	Mid-channel, 1.6 km SW of Petersons Pt.; 17.8 m.	PAXMH	DNR phytoplankton (live)	OEP XDE2792	38 22.7321491 76 30.6793504	12x4
Patuxent	LE1.3	Mid-channel 1200 m due N of Pt. Patience, ESE of Half Pone Pt; 23.1 m.	PAXMH		OEP XDF0407	38 20.4525027 76 29.2932417	12x4
Patuxent	LE1.4	Mid-channel on a transect between Drum Pt. and Fishing Pt; 16.5 m.	PAXMH		OEP XCF8747	38 18.7201675 76 25.2906509	12x4
Patuxent	CB5.1W	Mid-channel on a transect between Cedar Pt and Cove Pt; 8.9m	PAXMH		OEP XCF9575	38 19.5132231 76 22.5444132	12x4
Potomac	PIS0033	Piscataway Creek at Maryland Rt 210 crossing; 1.0 m.	PISTF	Sampled in coordination with mainstem;		38 41.9049785 76 59.2039713	12x1
Potomac	XFB1986	Piscataway Creek off Ft. Washington Marina between DM4 and DM6, SW of dredged channel; 2.0 m.	PISTF	Sampled in coordination with mainstem; DNR phytoplankton (live)		38 41.8719243 77 01.3904020	12x1
Potomac	MAT0078	Mattawoman Creek at MD. Rt 225 crossing; 1.0 m.	MATTF	Sampled in coordination with mainstem		38 35.3113741 77 07.1188127	12x1
Potomac	MAT0016	Mattawoman Creek at green day beacon 5 off Sweden Pt; 2.0 m.	MATTF	Sampled in coordination with mainstem; DNR phytoplankton (live)		38 33.9049510 77 11.6071105	12x1
Potomac	TF2.1	At FI buoy 77 off mouth of Piscataway Creek; 19.0 m.	POTTF	Sampled in coordination with mainstem; DNR phytoplankton (live)	OEP XFB2470 EPA – several	38 42.3986386 77 02.9254704	12x3
Potomac	TF2.2	Buoy 67 off mouth of Dogue Creek; 8.0 m.	POTTF	Sampled in coordination with mainstem; DNR phytoplankton (live)	OEP XFB1433 USGS 384136077054600 EPA – Several	38 41.4405123 77 06.6665873	12x3
Potomac	TF2.3	Buoy N54 mid-channel off Indian Head; 15.0 m.	POTTF	Sampled in coordination with mainstem; DNR phytoplankton (live); VSS, plankton	OEP XEA6596	38 36.4933884 77 10.4383095	12x3
Potomac	TF2.4	Buoy 44 between Possum Pt. And Moss Point; 9.0 m.	POTTF	Sampled in coordination with mainstem; DNR phytoplankton (live)	OEP XEA1840 USGS 06158710 EPA- Several	38 31.8040859 77 15.9220599	12x3
Potomac	RET2.1	Buoy 27 SW of Smith Point; 8.0 m.	POTOH	Sampled in coordination with mainstem; DNR phytoplankton (live)	OEP XDA4238 EPA – Several	38 24.2084721 77 16.1451661	12x3
Potomac	RET2.2	Buoy 19 mid-channel off Maryland Point; 11.0 m.	POTOH	Sampled in coordination with mainstem; DNR phytoplankton (live), VSS, plankton	OEP XDA1177 EPA - Several	38 21.1519219 77 12.3049300	12x3

Component	Station Name	Location/Depth	Ches. Bay Program Segment	Sampling Coordination	Historical Station names	Latitude/ Longitude (NAD83 DMS)	Annual Sample Freq. x No. Of Depths
Potomac	RET2.4	Mid-channel at Morgantown bridge (US Rt. 301); 19.0 m.	POTMH	Sampled in coordination with mainstem; DNR phytoplankton (live), VSS, DNA probe	OEP XDC1706 USGS 01660800 EPA - Several	38 21.7559638 76 59.4376865	12x4
Potomac	LE2.2	Potomac River off Ragged Point at Buoy 51B; 10.0 m.	POTMH	Sampled in coordination with mainstem; DNR phytoplankton (live), PAR, VSS, plankton	OEP XBE9541	38 09.4563269 76 35.8815408	12x4
Potomac	LE2.3	Mouth of Potomac River (1.6 nm from Pt Lookout on Hdg 240, 0.5 nm NW of Whistle A); 19.8 m	POTMH	Sampled on mainstem cruise	OEP XBF0893	38 00.8526905 76 20.7688597	14x4
Tributary	ET1.1	Northeast River at Daymarker 12 off Hance Pt, mid-channel; 3.0 m.	NORTF	Striped bass spawning	OEP XKI4220 OEP XKI3717 OEP XKI4523 OEP XKI5025	39 34.1856660 75 58.0692371	12x2
Tributary	ET2.1	C&D Canal E of Rt 213 Bridge at Chesapeake City; 13.0 m.	C&DOH	DNR spawn habitat, striped bass spawning, C&D Canal	OEP XKJ1810 OEP XKJ1811	39 31.7580105 75 48.6809202	12x2
Tributary	ET2.2	Bohemia River off Hack Pt, 75 yds ENE of daymarker R 4, midchannel; 3.0 m.	BOHOH	DNR juvenile striped bass spawning	OEP XJI8076 OEP XJI7678 EPA U9	39 28.0223692 75 52.4205850	12x2
Tributary	ET2.3	Elk River SE of Old Cornfield Pt at G 21, mid-channel; 12.0 m.	ELKOH	Striped bass spawning, DNR juvenile	OEP XKI0661 EPA U10	39 30.5236131 75 53.8694267	12x2
Tributary	ET3.1	Sassafras R from end of pier at Georgetown Yacht Basin, NW side of MD. Rt. 213 bridge; 5.0 m.	SASOH	DNR phytoplankton (live); DNA probe, Striped bass spawning, DNR juvenile	OEP XJI1970 EPA U1	39 21.8493407 75 52.9218567	12x2
Tributary	ET4.1	Chester River at Rt 290 bridge near Crumpton; 6.0 m.	CHSOH	Striped bass spawning	OEP CHE0367	39 14.6244548 75 55.4932080	12x2
Tributary	ET4.2	Lower Chester River South of Easter Neck Island 200 yds SW of buoy FL G 9; 16.0 m.	CHSMH	DNA probe , DNR oyster spat	OEP XGG9572 CBI CHO9C	38 59.5398961 76 12.9055791	12x4
Tributary	EE1.1	Eastern Bay between Tilghman Pt and Parsons Island, N of buoy R4; 13.0 m.	EASMH	DNR oyster spat, Phytoplankton for MSU	OEP XGG2649 CBI 851N	38 52.7994975 76 15.0873372	12x4
Tributary	ET5.1	Upper Choptank River 200 yds upriver from Ganey's Wharf, downstream of confluence with Tuckahoe Creek; 6.0 m.	CHOOH	Plankton, , DNR spawning habitat, DNR juvenile, striped bass spawning	OEP CHO0429	38 48.3872185 75 54.5823145	12x2
Tributary	ET5.2	Lower Choptank River, midriver 50yds NNE of G I, W of Rt 50 bridge at Cambridge; 11.0 m.	CHOMH2	DNR phytoplankton (live), Plankton, DNR juvenile, DNR spawning habitat	OEP XEH4766	38 34.8394323 76 03.5202530	12x4
Tributary	EE2.1	Choptank embayment between Todds Point and Nelson Pt; 8.0 m.	CHOMH1	DNA probe, Near DNR oyster spat	OEP XEG9440 OEP XEG9652	38 39.2945815 76 15.8585779	12x4
Tributary	EE2.2	Little Choptank River mid-channel West of Ragged Point, W of Buoy Fl g 3; 14.0 m.	LCHMH	DNA probe, DNR oyster spat	OEP XEG1617	38 31.5656341 76 18.2448493	12x2

Component	Station Name	Location/Depth	Ches. Bay Program Segment	Sampling Coordination	Historical Station names	Latitude/ Longitude (NAD83 DMS)	Annual Sample Freq. x No. Of Depths
Tributary	TRQ0146	Transquaking River at Decoursey Rd. bridge crossing; 2.2 m.	N/A	DNA probe <i>Pfiesteria</i> sampling 1998-2002		38 27.9394360 76 00.0061642	12x1
Tributary	TRQ0088	Transquaking River at bridge on Bestpitch Ferry Rd; 2.7 m.	N/A	DNA probe <i>Pfiesteria</i> sampling 1998-2002 Continuous monitoring		38 25.0361348 75 59.6067549	12x1
Tributary	CCM0069	Chicamacomico River at Drawbridge road crossing. 2.4 m.	N/A	DNA probe <i>Pfiesteria</i> sampling 1998-2002 Continuous monitoring 2000-2003		38 26.5366979 75 54.2854815	12x1
Tributary	EE3.0	Fishing Bay at daymarker 3, W of Roasting Ear Pt; 7.0 m.	FSBMH	VSS, DNR Phytoplankton (live), DNA Probe	OEP XCH6994 OEP XCH5991	38 16.8560762 76 00.6198796	12x2
Tributary	ET6.1	Upper Nanticoke River at old Rt. 313 bridge (fishing pier, 1987) in Sharptown; 5.0 m.	NANTF	VSS, DNR juvenile, DNR oyster spat	OEP NAN03021	38 32.9039050 75 42.1870554	12x2
Tributary	XDJ9007	Nanticoke River at old Rt 50 bridge in Vienna; 1.8 m.	NANOH	DNA probe <i>Pfiesteria</i> sampling 1998-2002		38 29.0248218 75 49.2586029	12x1
Tributary	ET6.2	Lower Nanticoke River mid-channel near Fl G 11; 3.5 m.	NANMH	DNR Phytoplankton (live), DNA probe, VSS, DNR juvenile, DNR oyster spat	Near OEP XDI0567 Near OEP XDI0567	38 20.4963799 75 53.2476826	12x2
Tributary	EE3.1	North Tangier Sound, NW of Haines Pt, 100 yds N of buoy R16; 13.0 m.	TANMH	Phytoplankton for MSU	OEP XCI1717	38 11.8113063 75 58.3925178	12x4
Tributary	WIW0141	Wicomico River at upper ferry crossing on Upper Ferry Road; 3.9 m.	WICMH	DNA probe <i>Pfiesteria</i> sampling 1998-2002		38 20.4916929 75 41.7412721	12x1
Tributary	ET7.1	Lower Wicomico River at Whitehaven, 150 yds downriver of Ferry Road, mid-channel; 7.0 m.	WICMH	DNR Phytoplankton (live), DNA probe, VSS	OEP WIW0050	38 16.0701067 75 47.2761282	12x2
Tributary	XCI4078	Wicomico River at Island Pt. in channel at buoy Fl14; 4.4 m.	WICMH	DNA probe <i>Pfiesteria</i> sampling 1998-2002		38 14.0271564 75 52.1777364	12x1
Tributary	MNK0146	Manokin River on unnamed Rd. Off Stewart Neck Rd. below unnamed tributary; 4.7 m.	N/A	DNR phytoplankton (live), DNA probe <i>Pfiesteria</i> sampling 1998-2002		38 10.5079461 75 43.3412509	12x1
Tributary	BXK0031	Back Creek (tributary to Manokin) at Milliard Long Rd; 2.6 m.	MANMH	DNA probe <i>Pfiesteria</i> sampling 1998-2002		38 08.1379293 75 45.0938889	12x1
Tributary	ET8.1	Manokin River at upper extent of channel; approx 100 yds NNE of buoy R 8, mid-channel; 6.0 m.	MANMH	VSS, DNR oyster spat	OEP XBJ8215	38 08.2763096 75 48.8466000	12x2
Tributary	ET9.1	Big Annemessex River, NW of Long Pt in channel S of daymarker G5; 5.0 m.	BIGMH	VSS	OEP XBJ3312	38 03.2985616 75 48.6783371	12x2
Tributary	EE3.2	South Tangier Sound, mid-channel East of Smith Island, 500 yds NNW of buoy R8; 28.0 m.	TANMH	DNR oyster spat, Phytoplankton for MSU	OEP XAI8845 Near OEP XBI3003	37 58.8833649 75 55.4537786	12x4

Component	Station Name	Location/Depth	Ches. Bay Program Segment	Sampling Coordination	Historical Station names	Latitude/ Longitude (NAD83 DMS)	Annual Sample Freq. x No. Of Depths
Tributary	ET10.1	Pocomoke River on Alt US Rt. 13 (Market Street) on old drawbridge in Pocomoke City; 5.0 m.	POCTF	Striped Bass spawning	OEP POK0170	38 04.5687574 75 34.2749080	12x2
Tributary	POK0087	Pocomoke River off Rehobeth Rd in town of Rehobeth 1.3 m.	POCOH	DNA probe <i>Pfiesteria</i> sampling 1998-2002		38 02.3102060 75 39.6738628	12x1
Tributary	XAK7810	Pocomoke Sound at middle of mouth of river; 3.4 m.	POCOH	DNR Phytoplankton (live), DNA probe, <i>Pfiesteria</i> sampling 1998-2002		37 57.8374074 75 39.0283151	12x1
Tributary	EE3.3	Pocomoke Sound, near buoy W "A" Pa, state line; 4.0 m.	POCMH	DNR oyster spat	Near OEP XAJ4719 Near VA EE3.1	37 54.8729048 75 48.0889235	12x2
Tributary	WT1.1	Bush River E of Gum Point, E of FI G9 on power line support; 2.0 m.	BSHOH		OEP XJG6254	39 26.1067440 76 14.5231684	12x2
Tributary	WT2.1	Gunpowder River, 200 yds E of Oliver Point at buoy G15; 2.5 m.	GUNOH	DNA probe	OEP XJF2798	39 22.6479745 76 20.0788035	12x2
Tributary	WT3.1	Middle River East of Wilson Point at channel junction daymarker WP; 3.0 m.	MIDOH	DNR phytoplankton (live), DNA probe	OEP XIF5484 EPA M2	39 18.3229657 76 24.5721377	12x2
Tributary	WT4.1	Back River, East of Stansbury Point, East of daymarker R12; 2.0 m.	BACOH	DNA probe	OEP XIF6633 Near OEP XIF6732	39 16.6526474 76 26.6207773	12x2
Tributary	WT5.1	Patapsco River East of Hawkins Point at Buoy G3; 14.0 m.	PATMH	DNR phytoplankton (live), DNA probe, plankton	OEP XIE2885	39 12.7856735 76 31.3521434	12x4
Tributary	WT6.1	Magothy River N of South Ferry Pt, mid-channel at buoy R12 and daymarker G11; 5.0 m.	MAGMH		OEP XHE4794	39 04.7103548 76 30.6031007	12x2
Tributary	WT7.1	Severn River, 200 yds upstream of Rt 50/301 bridge and 150 yds off NE shore; 9.0 m.	SEVMH		OEP XHE0497	39 00.4583154 76 30.2100203	12x2
Tributary	WT8.1	South River South of Poplar Point at daymarker R16; 9.0 m.	SOUMH		OEP XGE6972	38 56.9761002 76 32.7659239	12x2
Tributary	WT8.2	Rhode River between Flat Island and Big Island; 3.0 m.	RHDMH		OEP XGE3279	38 53.2172578 76 32.0941083	12x2
Tributary	WT8.3	West River just upstream of daymarker R6; 4.0 m.	WSTMH		OEP XGE0579	38 50.5481653 76 32.0482195	12x2
Tributary	XHH4742	Corsica River; 2.4 m.	CHSMH			39 04.684 76 05.382	12x1

KEY FOR Historical Stations:

Abbreviation	Description
CBI	Chesapeake Bay Institute, Johns Hopkins University, 1949-1980
EPA/AFP	EPA, Annapolis Field Office studies, 1969-1970
EPA	EPA, Water Quality Office, Chesapeake Technical Support Laboratory, 1967-1969
USDI	U.S. Department of the Interior, Federal Water Pollution Control Administration, Chesapeake Technical Support Laboratory, 1965-1968
U.S.G.S	U.S. Geological Survey Water Quality of the Potomac River and Estuary Hydrologic Data Report, 1978-1981
OEP	Office of Environmental Programs, Maryland Department of Health and Mental Hygiene, 1984-1987; this program was moved to Maryland Department of the Environment 1987-1996 and to the Maryland Department of Natural Resources 1996-present; the current sample names were adopted in 2000 to conform to EPA Chesapeake Bay Program station names.

NOTE: Refer to Appendix I for details on the physical/chemical parameter sampling. Refer to the following work plan/scope of work for details on the plankton monitoring component:

Butler, W.L. 2010. *Quality Assurance/Quality Control Work Plan Monitoring Program: Phytoplankton Monitoring Program*. Department of Natural Resources, Field Office: Annapolis, MD. April 16, 2010.

2. MEASURED PARAMETERS

The Chemical and Physical Properties Component of the Chesapeake Bay Water Quality Monitoring Program measures a broad suite of physical and chemical parameters that are indicative of the Bay's eutrophication problem. Several "natural" properties such as salinity and temperature in the water column provide important information for interpretation of water quality indicators.

Some parameters—conductivity, temperature, dissolved oxygen, pH, Secchi depth—are measured *in situ* using water quality sonde instrumentation manufactured by Hydrolab or Yellow Springs Instruments (YSI). Salinity is calculated from conductivity and temperature.

Beginning in February 2009, YSI Series 6820 instruments were added to the field instrument inventory.

YSI instruments are equipped with an optical dissolved oxygen sensor (ROX) instead of the Standard Clark Polarographic Sensor. Temperature, pH, specific conductance and depth sensors perform similarly to respective Hydrolab sensors. Both the Hydrolab and YSI optical dissolved oxygen sensors use similar luminescent technology and phase shift techniques to measure dissolved oxygen.

During 2009 Hydrolab Series 5 instruments were converted from Standard Clark Polarographic Dissolved Oxygen Sensors to Optical Dissolved Oxygen Sensors known as Luminescent Dissolved Oxygen (LDO). Temperature, pH specific conductance and depth sensors will not be changed. All other Hydrolab instruments will continue to have Standard Clark Polarographic Dissolved Oxygen Sensors. Sensor differences in each Series of instrument are noted in Appendix V. (Routine Sensor Maintenance and Performance Verification IV. B.).

Mainstem and Patuxent River cruises will exclusively use YSI instead of Hydrolab instruments. All other sampling activities will use Hydrolab or YSI instruments.

This document may be amended when the Hydrolab Series 5 and YSI 6820 instruments are fully incorporated into the inventory and their use and procedures receive approval from the Chesapeake Bay Program Quality Assurance Officer.

The other measured parameters—including nitrogen, phosphorus, carbon and silicon species, total suspended solids, volatile suspended solids and chlorophyll *a*—are determined in the laboratory. Table 2 lists the parameters measured, their detection limits, methods references, and holding times and conditions. Details of sample collection, sample processing and storage, and analytical procedures are described in Appendices I, and VII.

The Chesapeake Biological Laboratory Nutrient Analytical Services Laboratory (NASL) is working to revise Standard Operating Procedures (SOP) to reflect changes in procedures and instrumentation and will be working with the EPA Quality Assurance Officer and DNR Quality Assurance Officer to develop a timeline for delivery of the updated and revised SOP to the EPA Chesapeake Bay Program. The revised NASL SOP will include procedures recommended in the GAP Analysis.

The NASL has already implemented many of the GAP Analysis recommendations. All laboratory methods used by NASL for MD DNR analyses have been updated. The updated methods were written to comply with National Environmental Laboratory Accreditation Conference (NELAC) guidance and recommendations. An organization chart is being created. Documentation of procedures for logging-in and tracking samples, standards and reagents is being developed.

Appendix VII is a work in progress.

Documents in Appendix VII include: *Determination of Dissolved Inorganic Nitrate plus Nitrite (NO₃+NO₂) in Fresh/Estuarine/Coastal Waters Using Cadmium Reduction, 13-Jan-09; Determination of Dissolved Inorganic Nitrate plus Nitrite (NO₃+NO₂) in Fresh/Estuarine/Coastal Waters Using Enzyme Catalyzed Reduction, 13-Jan-09; Determination of Dissolved Inorganic Ammonium (NH₄) in Fresh/Estuarine/Coastal Waters, 19-Mar-09; Determination of Dissolved Inorganic Nitrite (NO₂) in Fresh/Estuarine/Coastal Waters, 12-Mar-09; Determination of Dissolved Inorganic Orthophosphate (PO₄) in Fresh/Estuarine/Coastal Waters, 19-Feb-09; Determination of Total Dissolved Nitrogen (TDN) in Fresh/Estuarine/Coastal Waters Using Alkaline Persulfate Digestion of Nitrogen to Nitrate and Measured Using Cadmium Reduction, 13-Apr-10; Determination of Total Dissolved Phosphorus (TDP) in Fresh/Estuarine/Coastal Waters Using Alkaline Persulfate Digestion of Phosphorus to Orthophosphate (PO₄), 13-Apr-10; Determination of Total Dissolved Nitrogen (TDN) in Fresh/Estuarine/Coastal Waters Using Alkaline Persulfate Digestion of Nitrogen to Nitrate and Measured Using Enzyme Catalyzed Reduction, 13-Apr-10; Determination of Total Particulate Phosphorus (TPP) and Particulate Inorganic Phosphorus (PIP) in Fresh/Estuarine/Coastal Waters, 1-Dec-09; Determination of Total Suspended Solids (TSS) and Total Volatile Solids (TVS) in Fresh/Estuarine/Coastal Waters, 2008; Determination of Dissolved Organic Carbon (NPOC), Total Organic Carbon, and Dissolved Inorganic Carbon in Fresh/Estuarine/Coastal Waters Using High Temperature Combustion and Infrared Detection, 8/12/2009; Determination of Carbon and Nitrogen in Particulates and Sediments of Fresh/Estuarine/Coastal Waters, Plant and Animal Tissue and Soils Using Elemental Analysis, 2008; Spectrophotometer Determination of Chlorophyll *a* in Waters and Sediments of Fresh/Estuarine/Coastal Areas, 3/31/2010; Determination of Silicate from Fresh, Estuarine, Coastal Waters Using the Molybdosilicate Method on the AquaKem 250 Analyzer 8/14/2009.*

Current versions of NASL methods documents are maintained on-line by NASL and may be accessed at the following URL: <http://nasl.cbl.umces.edu/Methods.htm>.

Beginning in January 2009, chlorophyll analysis by the Maryland Department of Health and Mental Hygiene ceased and the Chesapeake Biological Laboratory, Nutrient Analytical Services Laboratory assumed responsibility for analyzing chlorophyll samples.

Table 2 Water Column Parameters, Detection Limits, Methods References, Holding Times and Conditions.

Parameter (Units)	Instrument	Detection Limit (or Range)	Method Reference	Holding Time and Condition
IN SITU				
Temperature (° C)	Hydrolab Series 4000 and 2	-5 to +45°C	Linear thermistor (HOM-S4000, HOM-S2)	Not applicable <i>in situ</i>
	Hydrolab Series 3, 4a, and 5	-5 to +50°C	Linear thermistor (HOM-S3, HOM-S4)	
	YSI Series 6	-5 to +50°C	Thermistor of sintered metallic oxide (YSIUM-S6)	
Depth (m)	Hydrolab Series 2	0-200 m	Strain gauge pressure transducer, non-vented (HOM-S2)	
	Hydrolab Series 3, 4a, and 5	0-100 m	Strain gauge pressure transducer, non-vented, stainless steel (HOM-S3, HOM-S4)	
	YSI Series 6	0-61 m	Differential strain gauge transducer, non-vented (YSIUM-S6)	
Dissolved Oxygen (mg/L)	Hydrolab Series 4000, 2, 3, and 4a	0-20 mg/L	Standard Clark Au/Ag Polarographic Cell (HOM-S4000, HOM-S2, HOM-S3, HOM-S4))	
	Hydrolab Series 5	0-50 mg/L	Standard Clark Au/Ag Polarographic Cell (HOM-S4)	
	Hydrolab Series 5	0-20 mg/L	Optical Probe – Luminescent Dissolved Oxygen Probe (LDO) (HOM-S4)	
	YSI Series 6	0-50 mg/L	Rapid Pulse Clark-type Au/Ag Polarographic Cell or ROX Optical Dissolved Oxygen (YSIUM-S6)	

IN SITU continued

Parameter (Units)	Instrument	Detection Limit or Range	Method (Reference)	Holding Time and Condition
Specific Conductance	Hydrolab Series 4000	0-200 mS/cm	Four nickel electrode cell (HOM-S4000)	
	Hydrolab Series 2	0-150 mS/cm	Six nickel electrode cell (HOM-S2)	
	Hydrolab Series 3	0-100 mS/cm	Six nickel electrode cell (HOM-S3)	
	Hydrolab Series 4a and 5	0-100 mS/cm	0.25" x 1" oval bore with four graphite electrodes (HOM-S4)	
	YSI Series 6	0-100 mS/cm	Four nickel electrode cell (YSIUM-S6)	
pH	Hydrolab Series 4000 and 2	0-14 pH units	Paired bulb type Ag/AgCl glass <i>in situ</i> and rebuildable reference probes – reference probe in sleeve filled with saturated KCl/pH7 buffer and capped with replaceable porous Teflon™ junction (HOM-S4000, HOM-S2)	Not applicable <i>in situ</i>
	Hydrolab Series 3, 4a, and 5		Paired bulb type Ag/AgCl glass <i>in situ</i> probe and Silver pellet reference probe – reference probe in sleeve filled with 4M KCl saturated with AgCl and capped with replaceable porous Teflon™ junction (HOM-S3, HOM-S4))	
	YSI Series 6		Combined glass bulb type electrode with Ag/AgCl reference electrode (YSIUM-S6)	
Secchi Depth (m)		0.1 - 7.0 m	20 cm diameter disk with alternating black and white quadrants (Welch, 1948)	
Light Attenuation* (Photosynthetic Active Radiation) (two measurements - one from boat and one taken at depth with an up sensor)		400–700 nm	Parsons (1977); Smith (1969), CBP F01	

* Light Attenuation is not measured by MD DNR on Mainstem cruises or in Tributaries except the Patuxent River.

However, MSU does collect light attenuation data on Mainstem cruises. MSU delivers the light attenuation data directly to CIMS.

GRAB SAMPLES			
Parameter (Units)	Detection Limit (or Range)	Method Reference	Holding Time and Condition
Orthophosphate (mg/L as P)	0.0006 mg/L	EPA method 365.1 (EPA 1993) Aquakem 250	Freezing-28 d
Total Diss. Phosphorus (mg/L as P)	0.0015 mg/L	Aquakem 250 and AutoAnalyzer II Valderrama 1981, Alkaline persulfate digestion	Freezing-28 d
Particulate Phosphorus (mg/L as P)	0.0021 mg/L	Aspila et al. 1976 Aquakem 250	Freezing-28 d
Nitrite (mg/L as N)	0.0006 mg/L	EPA method 353.2 (EPA 1993) Aquakem 250	Freezing-28 d
Nitrite + Nitrate (mg/L as N)	0.0007 mg/L	EPA method 353.2 (EPA 1993) and enzymatic nitrate method. Aquakem 250	Freezing-28 d
Ammonium (mg/L as N)	0.006 mg/L	EPA method 350.1 (EPA 1993) Aquakem 250	Freezing-28 d
Total Dissolved Nitrogen (mg/L as N)	0.05 mg/L	Aquakem 250 and AutoAnalyzer II D'Elia et al. 1977; Valderrama 1981, Alkaline persulfate digestion	Freezing-28 d
Particulate Nitrogen (mg/L as N)	0.0105 mg/L	EPA method 440.0 (EPA 1997)	Freezing-28 d
Dissolved Organic Carbon (mg/L as C)	0.24 mg/L	Sugimura and Suzuki (1988)	Freezing-28 d
Particulate Carbon (mg/L as C)	0.0633 mg/L	EPA method 440.0 (EPA 1997)	Freezing-28 d
Silicic Acid (mg/L as Si)	0.01 mg/L	EPA method 366.6 (EPA 1997) Aquakem 250	4°C - 28 d
Total Suspended Solids (mg/L)	2.4 mg/L	Standard Method (APHA 19th or 20th edition) Method 2540 D	Freezing-28 d
Volatile Suspended Solids (mg/L)	0.9 mg/L	Standard Method (APHA 19th or 20th edition) Method 2540 D	Freezing-28 d
Chlorophyll a (µg/L)	0.62 µg/L	Standard Methods 10200H, 21st Ed.	Freezing-28 d
Pheophytin a (µg/L)	0.74 µg/L	Standard Methods 10200H, 21st Ed.	Freezing-28 d

REFERENCES for Table 2:

American Public Health Association (APHA), *Standard Methods for the Examination of Water and Wastewater, Method Number 10200H*, 21st Edition, 2005.

American Public Health Association (APHA), *Standard Methods for the Examination of Water and Wastewater, Method Number 2540 D*, 20th Edition, 1998.

American Public Health Association (APHA). 1975. Method 208D, total non-filterable residue dried at 103-105°C (total suspended matter), in *Standard Methods for the Examination of Water and Wastewater*, 14th Edition. APHA: Washington, D.C. 1193 p.

Aspila, I., H. Agemian and A. S. Y. Chau. 1976. A semi-automated method for the determination of inorganic, organic and total phosphate in sediments. *Analyst* 101:187-197.

D'Elia, C. F., P. A. Steudler and N. Corwin. 1977. Determination of total nitrogen in aqueous samples using persulfate digestion. *Limnol. Oceanogr.* 22:760-764.

Hydrolab System Water Quality Instrumentation Manual (HSWQIM). 1984-1998 (multiple editions). Published by Hydrolab Corporation, P.O. Box 50116, Austin, Texas.

Parsons, T.R., Takahashi, M. and B. Hargrave. 1977. *Biological Oceanographic Processes*. Pergamon Press. Oxford. 332 p. (pages 71-85).

Patton, C.J., A.E. Fischer, W.H. Campbell and E.R. Campbell. 2002. Corn leaf nitrate reductase- A nontoxic alternative to cadmium for photometric nitrate determinations in water samples by air-segmented continuous-flow analysis. *Env Sci. and Technology* 36(4):729-735

Smith, R. C. 1969. An underwater spectral irradiance collector. *J. Mar. Res.* Vol. 27: 341-351.

Sugimura, Y. and Y. Suzuki. 1988. A high temperature catalytic oxidation method for the determination of non-volatile dissolved organic carbon in seawater by direct injection of a liquid sample. *Mar. Chem.* 24:105 - 131.

US Environmental Protection Agency (EPA). 1997. *US EPA Method 440.0. Determination of Carbon and Nitrogen in Sediments and Particulates of Estuarine/Coastal Waters Using Elemental Analysis*. Revision 1.4. National Exposure Research Laboratory, Office of Research and Development, US Environmental Protection Agency: Cincinnati, OH.

US Environmental Protection Agency (EPA). 1993. *Methods for the Determination of Inorganic Substances in Environmental Samples* EPA-600/R-93/100.

US Environmental Protection Agency (EPA). 1979. *Methods for Chemical Analysis of Water and Wastes*. EPA-600/4-79-020. 460 p.

Valderrama, J. C. 1981. The simultaneous analysis of total nitrogen and total phosphorus in natural waters. *Mar. Chem.* 10:109-122.

Welch, P.S. 1948. Chapter 11 in *Limnological Methods*. Blakiston: Philadelphia, PA. pp. 159-167.

3. FIELD MEASUREMENTS AND SAMPLING

Sampling procedures have been formulated for each part of the Maryland's Chemical and Physical Properties Component of the Chesapeake Bay Water Quality Monitoring Program to take measurements that meet the program objectives in an efficient, cost-effective, and logistically practical manner.

As defined in the Scope of Work, a total of 21 mainstem stations and 70 tributary stations are included in the Chemical and Physical Properties Component of the monitoring program (see Figure 1 and Table 1 above in Section 1). Water column samples are collected at least once a month at most stations, for a minimum of twelve samplings per year. In the Chesapeake mainstem, sampling will be conducted twice monthly in June, and August of 2010, and once monthly during the remaining months, for a total of fourteen samplings in the period of July 1, 2010 - June 30, 2011. However, at eastern and western transect mainstem stations, samples will not be collected from November through February, resulting in only ten samplings a year. On the Potomac and Patuxent and smaller tributaries, twelve samplings will be conducted per year. The current frequency of sampling for each station is shown in Table 1 (provided above in Section 1).

The water column is profiled for temperature, conductivity, dissolved oxygen, and pH using an *in situ* probe that transmits data to a shipboard readout via cable. Profiling is conducted at a minimum of 2 m sampling intervals. In strata where there is appreciable change in conductivity or dissolved oxygen (i.e., at the pycnocline), 1 m intervals are sampled. The protocols for determining profiling depths are detailed in Appendix I.

Water column grab samples collected for subsequent analysis in the laboratory are taken by submersible pump or water bottle. The number of depths sampled per station is listed in the last column of Table 1.

One or two depths are sampled at stations that do not normally exhibit vertical density stratification. For stations where samples are collected at a single depth, the grab is collected from depth of either 0.0 m or 0.5 m depending on the site, with one exception. The depths of 0.5 m and 1 m above bottom are sampled at sites where grabs are made at two depths.

Four depths are sampled at stations that are normally density stratified: 0.5 m below the surface, 1.5 m above the upper limit of the pycnocline, 1.5 m below the lower limit of the pycnocline, and 1 m above the bottom. Grab sampling depths relative to the pycnocline are determined according to the protocols of Appendix I.

Details on filtration, containers, and storage techniques can also be found in Appendix I. This sampling protocol provides one or two measurements of the water column in well-mixed non-stratified regions and two additional measurements—one in the surface mixed layer and one in the bottom mixed layer—where the estuary is stratified into the typical two-layered flow pattern.

For the mainstem stations only, when there is an odor of hydrogen sulfide present in the bottom sample or the below pycnocline sample, a Hach Kit test for hydrogen sulfide presence on the bottom and/or below pycnocline sample(s) is performed.

Water transparency is measured by Secchi depth, determined in meters using a 20 cm standard Secchi disc lowered into the water column with a calibrated rope. Observations are made on the shady side of the boat.

4. LABORATORY ANALYSIS

All laboratory-measured parameters are analyzed at the University of Maryland's Chesapeake Biological Laboratory (CBL), Nutrient Analytical Services Laboratory (NASL). See Appendix VII for the NASL's Standard Operating Procedures and analytical methods.

Active chlorophyll *a* and pheophytin *a* samples were analyzed by the Maryland Department of Health and Mental Hygiene's (DHMH) Environmental Chemistry Division through December 2008. Beginning in January 2009 the NASL assumed responsibility for analyzing chlorophyll *a* and pheophytin *a*. See Appendix VII for NASL's chlorophyll analysis methods.

5. DATA MANAGEMENT, VERIFICATION AND DOCUMENTATION

Data collection for the Chemical and Physical Properties Component of the Chesapeake Bay Water Quality Monitoring Program begins when measurements from field recording instruments are entered onto field data sheets. A field log book is used to document any problems encountered in the field that might affect the field parameters or samples brought back to laboratory. The senior scientist, on board each cruise, ensures that all measurements are taken properly. All data acquisition processes in the field and laboratory measurements are recorded in the Cruise Report to ensure data quality. After field personnel complete data sheets for a given calendar month, they make photocopies of the sheets to keep in the Field Office, and send the original field sheets to data management staff at the DNR Tawes Building. The Field Office also generates a Cross Reference Sheet for each set of field sheets, which is sent to the DNR data management personnel along with the field data sheets. The Cross Reference Sheet allows the data management personnel to know what field, nutrient, lab, and chlorophyll lab sheets to expect. See Appendix II for field sheets and associated documentation, Appendix III for a Cross Reference Sheet and documentation, and Appendix IV for Cruise Report Documentation and Procedures.

Nutrient laboratory data sheets (nutrient volume sheets) are initiated in the field. The nutrient lab sheets are used to record basic information about samples, such as station, date, depth, and volume filtered. The sheets serve as sample transfer sheets, traveling with the samples to CBL's Nutrient Analytical Services Lab for nutrient or chlorophyll analysis. Both the sheets and the samples are logged in at the NASL.

At CBL, data generated from nutrient analyses are either (a) recorded directly to an electronic file; or, (b) handwritten onto a lab sheet and then keypunched into an electronic file by laboratory personnel. CBL does not keep active control charts. Instead, each instrument has an operator dedicated to that instrument. The dedicated operator is responsible for keeping track of the slopes of the regression analysis for that instrument to determine if the analyses are "in control." The analyst reviews the data and, if the data exceed their control limits, the entire run is re-analyzed. Re-analysis can occur for any number of reasons, such as, a poor r-squared (R^2) on the standard curve, the wrong set of pump tubes (which would

provide abnormally low peaks), or high blank values (in the case of DOC). See Appendix VII for CBL's procedures and methods.

When laboratory staff members complete the nutrient lab sheets and chlorophyll lab sheets, the sheets are sent to the DNR Tawes Building along with any electronic files that have been generated. See Appendix II for nutrient/chlorophyll lab sheets, and associated documentation. See Appendix X for a list of codes used on the sheets and to qualify analytical results when necessary.

Data review and verification are conducted at four levels by DNR data management personnel. At the first level, DNR data management personnel review cross reference sheets and field data sheets: (1) comparing field sheets to cross reference sheets to ensure that all field sheets have been received; (2) reviewing all field sheets to check that they are filled out completely and legibly, and; (3) sending the sheets to a data entry service for keypunch (see Appendix XI for procedures). At the data entry service, the field sheet data are double-entered to minimize errors at the keypunch stage. The entered field data are sent back to DNR as an electronic file on a diskette for further processing.

At the second level, a Data Processing Programmer generates reports and plots for data verification using the Water Quality Import v3 software. The WQ Import v3 software was designed in late 1998 and completely developed in 2000 in Microsoft Access. The WQ Import v3 software is used to import data and cross reference files and to conduct data management activities, such as performing initial data checks, conducting major key field checks, performing parameter range checks (including measured and calculated parameters), conducting combination checks for specific parameters, generating error reports and verification plots, generating a "data verified list," reforming data, creating a database, and submitting data. Data checks are listed in Exhibit 1.

Exhibit 1. Data Verification Conducted on Water Quality Data

- (1) Individual Data Parameter Checks:
 - (a) Range check for numeric data parameters (reports error if data are outside the normal range for that parameter).
 - (b) Character validation check for character data parameters (reports error if the character data are not appropriate for that parameter).
- (2) Parameter Combination Checks:
 - (a) Field Data:
 - Sample layer depth check (checks to make sure layer depths are appropriate, e.g., reports error if surface layer depth is greater than 1.0 m, surface depth is greater than bottom depth, etc.).
 - Upper and lower pycnocline check (reports error if pycnocline depths are outside expected range).
 - Maximum and minimum wind parameter check (reports error if minimum wind exceeds maximum wind).
 - (b) Laboratory Data:
 - APC code check for all laboratory related parameters (reports if APC code has been reported).
 - G code (greater than or less than detection limit flag) check for all laboratory related parameters (reports if lab has flagged values as greater or less than the detection limit).
 - Parameter combination check for the following parameters:
 - Parameters PO4 and TDP (reports error if $PO4 > TDP$).
 - Parameters NO23, NH4, and TDN (reports error if $NO23 + NH4 > TDN$).
 - Parameters NO2 and NO23 (reports error if $NO2 > NO23$).
 - (c) Chlorophyll Data: APC code checks with light path, extraction volume, and/or optical density parameters (reports error if values are outside expected range).
- (3) Verification Plots for Review: Sampling dates and times and values for all chemical and physical parameters are plotted by station for review by biologists and the Quality Assurance Officer. Biologists and the QAO look at patterns and identify any outliers or unusual values to be checked for errors.

Third, system printouts or PDF files of each data set are sent to a biologist and the Quality Assurance Officer for verification and editing. The Quality Assurance Officer and DNR biologists ensure that measured or calculated information for all types of data are correct and that the codes associated with

parameters are properly established. In addition, the Quality Assurance Officer identifies data problems, provides data correction instructions, and coordinates data correction activities. Possible errors are identified, and sent to the laboratory or field office for verification or verified over the phone. Any necessary corrections are written on an edit form, which is given to a programmer. The programmer makes changes to correct the electronic data set, re-runs the verification programs, and updates the verification reports and plots. This procedure is repeated until a clean data set is produced. Sample verification reports and plots and a sample edit form are provided in Appendix XII.

The fourth step is for data management staff to ensure that the overall data verification processes are completed, all data errors are corrected, and that the finalized data sets are created and formatted to be consistent with historical data sets. The final data set combining the field, lab, and chlorophyll data is created as an "MDB file" after the completion of data verification processes. This final data set is stored in the designated DNR data base directory on the \Tawesdata2\data_library server for data user access. A formatted submission data set and associated data documentation is also transferred to the Chesapeake Bay Program Data Center on a monthly basis. The data management process is diagrammed in Figure 2.

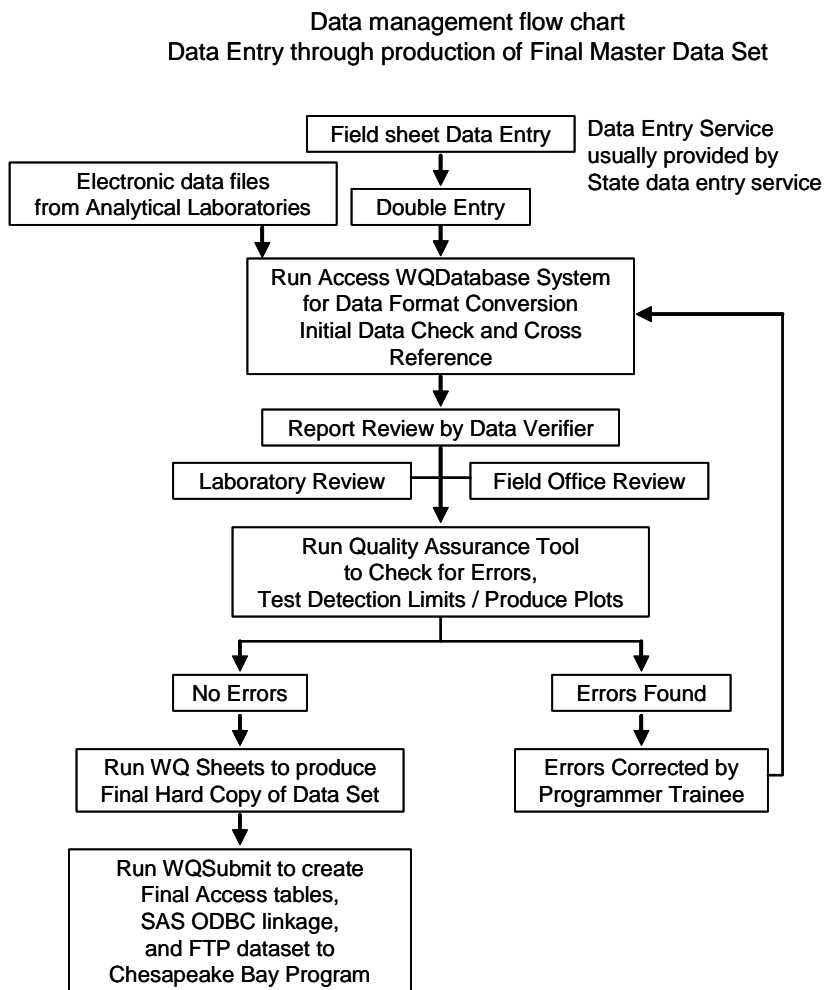

Figure 2 Data Management Flow Chart

A data tracking system has been designed and implemented to track the progress of data through the data management system. Data Status Forms are assigned to all data files received (see Appendix IX for example sheet and documentation). Data sheets and tracking sheets used in data management are stored at the DNR Tawes Building for seven years. The data tracking system is diagrammed in Figure 3.

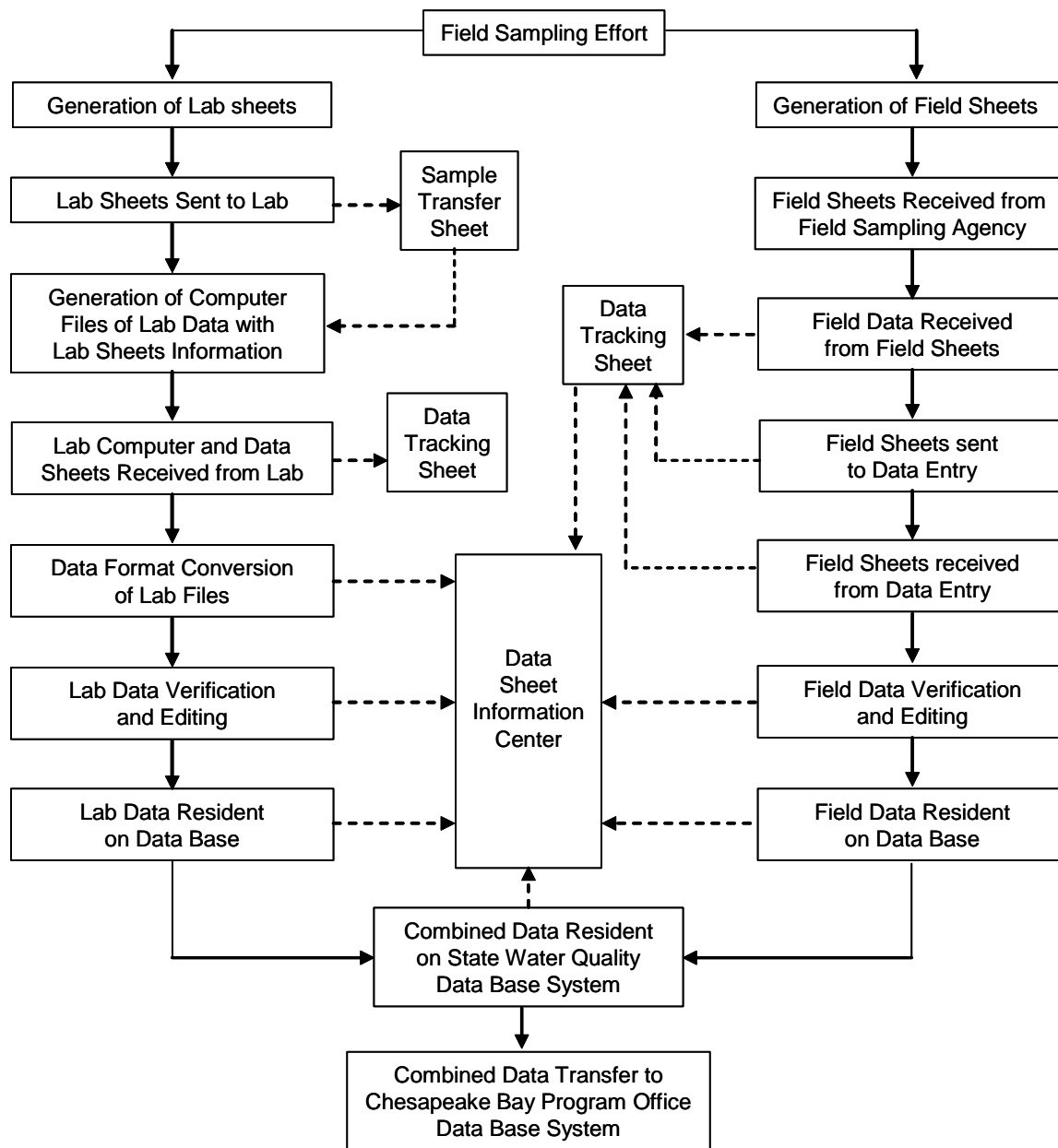

Figure 3 Data Tracking Flow Chart

Additionally, data from duplicate field samples are reviewed and analyzed by a scientist.

6. PROJECT QUALITY ASSURANCE/QUALITY CONTROL

The data collected as part of the Chemical and Physical Properties Component of the Chesapeake Bay Water Quality Monitoring Program are used in making management decisions regarding Chesapeake Bay water quality as described in the Introduction. DNR follows specific procedures to ensure that the design is properly implemented and that monitoring measurements are made and managed with sufficient accuracy, precision, and detection limits. General discussions of quality assurance and quality control aspects associated with accuracy, precision, data management, reporting, and audits are provided in the subsections below. For detailed descriptions of quality assurance and control procedures used in the field, the laboratories, and data management, see the attached appendices.

6.1 Accuracy

The accuracy (closeness to the true value) of the collected data is controlled and assured by the proper use, calibration, and maintenance of both field and laboratory equipment for the measurement of physical and chemical parameters. All instruments are identified by a unique number, used as an index for documentation of calibration, repair, and preventive maintenance. Where possible, standards used for calibration purposes are validated against a primary standard such as those available from the National Institute of Standards and Technology (NIST).

Daily quality control checks (including the running of blanks and standards) are used to control and assure laboratory accuracy. See Appendix VII for details on the frequency of running blanks and standards and for additional procedures for laboratory quality assurance and control.

Accuracy of laboratory results is also assessed through DNR's participation in the Chesapeake Bay Coordinated Split Sample Program (CSSP), a split sampling program in which the coordinated split samples are analyzed by five laboratories involved in Chesapeake Bay monitoring. CSSP was established in June 1989 to establish a measure of comparability between sampling and analytical operations for water quality monitoring throughout the Chesapeake Bay and its tributaries. DNR follows the protocols in the [*Chesapeake Bay Coordinated Split Sample Program Implementation Guidelines*](#) (EPA 1991) and its revisions. Split samples are collected quarterly. Results are analyzed by appropriate statistical methods to determine if results differ significantly among labs. When a difference occurs, discussion begins regarding techniques and potential methods changes to resolve discrepancies. A summary of the coordinated split sample program and a copy of the split sample custody log are provided in Appendix VII.

Additionally, CBL's Nutrient Analytical Services Laboratory will participate two times per year in the United States Geologic Survey (USGS) reference sample program and will permit USGS to release the results to the Chesapeake Bay Program Quality Assurance Officer.

Procedures to control and assure the accuracy of field measurements involve the calibration of field instruments, the verification of these calibrations, equipment maintenance, and collection of filter blanks. These procedures are detailed in Appendices V and VI.

When field replicate control limits are exceeded, or when field blank values exceed lowest calibration standards, information about the issue is presented to the Analytical Methods and Quality Assurance Work Group (AMQAW). AMQAW may suggest corrective actions to field and laboratory procedures.

6.2 Precision

Precision (repeatability) of the chemical analytical methods is determined and documented from duplicate analyses. Precision of the entire measurement system for laboratory-analyzed parameters, including field processing, storage, and chemical analysis, can be assessed from duplicate field samples. Duplicate field samples are routinely collected approximately every 20 samples, as described in Appendix I. The protocols for duplicate analyses in the laboratory are described in the Standard Operating Procedures for the Nutrient Analytical Services Laboratory in Appendix VII.

6.3 Data Review and Data Verification

Data review and data verification ensure the quality assurance and quality control of data. Corrective actions routinely taken when data checks fail are detailed above in Section V, DATA MANAGEMENT, VERIFICATION AND DOCUMENTATION.

6.4 Audits

Performance audits for chemical analyses conducted at the University of Maryland's Chesapeake Biological Laboratory are based on the results of samples distributed by the EPA Chesapeake Bay Program Blind Audit Program. These samples must fall within the 95% confidence interval for acceptance. If results fall outside this range, corrective actions for each parameter and measurement are taken. CBL prepares the blind audit samples for all CBP participating laboratories and also analyzes some of those samples. For dissolved nitrogen and dissolved phosphorus, a laboratory quality assurance officer determines the concentrations in the ampules, prepares the concentrates, and seals the ampules. A different person then analyzes the sample blindly. For the particulate fractions (particulate carbon/particulate nitrogen and particulate phosphorus), samples are filtered and then placed in pouches in the freezer until they are ready to be sent to the other CBP participating laboratories: Delaware Department of Natural Resources and Environmental Control, Hampton Roads Sanitation District, Maryland Department of Health and Mental Hygiene, Massachusetts Water Resource Authority, Morgan State University, University of Maryland's Horn Point Laboratory, University of Delaware College of Marine Science, Old Dominion University, the Pennsylvania Academy of Science, Pennsylvania Department of Environmental Resources, Virginia Institute of Marine Science, Virginia Division of Consolidated Laboratory Services, Virginia Polytechnic Institute's Occoquan Laboratory, and, finally, Chesapeake Biological Laboratory, itself.

Once annually, the EPA Chesapeake Bay Program quality assurance officer conducts an onsite audit of the mainstem laboratory and field programs. The DNR Quality Assurance Officer communicates on a weekly basis with the field program staff and confers with the laboratory quality assurance officers to ensure that all aspects of the program are being conducted properly.

Internal Audits of field sampling are regularly conducted annually by the Field Quality Assurance Officer. Field sampling audit results are then communicated to the Quality Assurance Officer.

6.5 Reporting

Quality assurance information for field duplicate samples in the mainstem and tributaries is stored on the routine computerized water quality data sets as replicate observations that can be used to assess precision.

For both the tributary and mainstem chemistry, laboratory quality assurance/control information on duplicates and spikes are stored on a computerized data set as a companion to the regular data sets and submitted to the CBPO quarterly. The DNR Quality Assurance Officer provides a summary of any relevant quality assurance/control information in quarterly progress reports for the mainstem program. The EPA Chesapeake Bay Program quality assurance officer reports on results of field and laboratory audits for the mainstem program.

6.6 Data Quality Indicators

To ensure that data are of the quality required to support Chesapeake Bay Program management decisions, Maryland's Chesapeake Bay Water Quality Monitoring Program strives to provide monitoring data of known and consistent quality to the CBPO by generally following the guidelines outlined in Chapter II, Section E of the [Recommended Guidelines for Sampling and Analysis in the Chesapeake Bay Monitoring Program](#), August 1996 (EPA 1996). These guidelines recommend precision goals of field and lab measurements of <20 percent of the coefficient of variation; accuracy goals within 80 to 120 percent, and the completeness goals of 100 percent. Detection limit ranges are provided in Table 2 above. Field measurement minimum detection limits are listed in Table 3.

PARAMETER	MINIMUM DETECTION LIMIT
Water Temperature	0.1 °C
Depth	0.5 m
Dissolved Oxygen	0.0 mg/L
Conductance, Specific	Down to 1 micromhos/cm at low levels (accurate to 3 significant digits)
pH	0.1 pH units
Secchi Depth	0.1 m
Salinity	0.1 ppt
Light Attenuation (PAR)	0.05% at 100% light

Table 3 Minimum Detection Limits for Field Measurements

7. DATA ANALYSIS AND REPORTING

As noted above, the key objectives of the Chesapeake Bay water quality monitoring program are to accurately describe the current state of the Bay mainstem and tidal tributaries and to detect long-term trends. Trends are analyzed using techniques recommended by the Chesapeake Bay Program's Tidal Monitoring and Analysis Work Group (TMAW, formerly the Data Analysis Work Group-DAWG), including the [Guidance for the Analysis of Water Quality Trends in the Chesapeake Bay](#) (Eskin et al. 1993) developed by DAWG in 1993. This published guidance provides general discussion on developing analytical objectives, reviewing and assembling data, and interpreting results. Data analysis topics covered in the document include:

- Selecting appropriate spatial and temporal scales;
- Exploring data characteristics such as distribution, censoring, trend characteristics (step versus monotonic), variances, seasonality, persistence, and missing data;
- Adjusting for flow variability; and,
- Considering the power and robustness of the tests.

The document also briefly discusses specific statistical tests, such as the seasonal Kendall test, Van Belle and Hughes intrablock tests, and Mann-Kendall tests, and corrections for serial dependence. TMAW makes recommendations and is working to update the *Guidance for the Analysis of Water Quality Trends in Chesapeake Bay* to help analysts reach technically sound conclusions and interpretations and to foster a consistent approach to trend analysis among the various investigators and multiple jurisdictions involved in the monitoring and analysis of Chesapeake Bay water and habitat quality.

Beyond analysis of the Maryland monitoring data, DNR staff participate in Chesapeake Bay Program Monitoring and Analysis Subcommittee (MASC) activities to produce Bay-wide analyses and reports with cooperating state, federal and local agencies. This activity leads to a better Bay-wide understanding of water and habitat quality and addresses the linkage between water quality and living resources. The Bay Agreement of 1987 also called for a re-evaluation of the nutrient strategies in 1991 and in 1997. Annual updates of water and habitat quality status and trends also were analyzed and summarized in [*The State of the Chesapeake Bay and the Watershed: A Progress Report January 3, 2008*](#), the [*Chesapeake Bay Nutrient Reduction Progress & Future Directions Nutrient Reduction Reevaluation Summary Report*](#) (CBP 1997), [*Bay Barometer, A Health and Restoration Assessment of the Chesapeake Bay and Watershed in 2009*](#), Tributary Strategy Team annual reports, and Basin Summary Reports.

The monitoring data also are used extensively in mathematical modeling efforts to project the water quality response of Chesapeake Bay to various management alternatives. A three-dimensional Chesapeake Bay and Tributary Water Quality time-variable model is presently under review. Results for earlier versions of the model have already been used to set nutrient reduction goals agreed to in the 1987 Bay Agreement and affirmed by the 1991 and 1997 Re-evaluations.

Other components of the DNR Chesapeake Bay Water Quality Monitoring Program are required to produce cumulative "Level I" data reports annually that describe the results of that component from the inception of the programs. These components include the Phytoplankton, Benthic, Ecosystem Processes, and River Input Programs. In addition to documenting the results of the individual monitoring components, these cumulative reports are intended to serve as "building blocks" for more integrated levels of analysis among the coordinated components.

8. PROJECT ORGANIZATION AND RESPONSIBILITY

This section lists the individuals responsible for the major aspects of the Chemical and Physical Properties Component of Maryland's Chesapeake Bay Water Quality Monitoring Program.

Director and Principal Investigator: Thomas Parham, Tidewater Ecosystem Assessment, DNR.

RESPONSIBILITIES: The director and principal investigator is responsible for overseeing the administrative aspects of the program including fiscal management, coordination among other DNR managers and coordination with cooperating agencies and institutions. This individual is also responsible for the technical design, conduct and data analysis of the program.

Quality Assurance Officer: Bruce Michael, Resource Assessment Service, DNR.

RESPONSIBILITIES: The quality assurance officer is responsible for documenting and assuring the conduct of field, laboratory, and data management procedures that comprise this study.

Field Sampling Operations: Sally Bowen, Project Chief, Monitoring Field Office, DNR

RESPONSIBILITIES: This individual is responsible for administration of the field sampling activities including sample collection, sample storage and sample delivery to laboratories.

Field Sampling Quality Assurance Officer: Greg Gruber, Natural Resources Biologist IV, Monitoring Field Office, DNR.

RESPONSIBILITIES: This individual is responsible for assuring the quality of field procedures and equipment used in this study.

Laboratory Analyses/Water Column Chemistry: Carl Zimmerman, University of Maryland, Chesapeake Biological Lab, Nutrient Analytical Services Laboratory

RESPONSIBILITIES: This individual is responsible for analysis of water samples collected in the mainstem and tidal tributaries.

Communications - Field: Bruce Michael, Resource Assessment Service, DNR

RESPONSIBILITIES: This individual is responsible for communications with Field Supervisors.

Communications - Laboratory: Renee Karrh, Thomas Parham, Tidewater Ecosystem Assessment, DNR

RESPONSIBILITIES: This individual is responsible for communications with Laboratory Supervisors.

Data Management: Mark Trice, Tidewater Ecosystem Assessment, DNR

RESPONSIBILITIES: This individual is responsible for overseeing the management of field and laboratory data collected under this program; managing historical field and laboratory data collected under this program; and maintaining existing data management software.

9. PROCEDURAL CHANGE PROTOCOL

Any permanent changes to field, laboratory or data management procedures must be approved by the Chesapeake Bay Program Office Quality Assurance Officer. Proposed changes are to be documented and submitted within 30 days using the Chesapeake Bay Program Procedure Modification Tracking Form. (See Appendix XIII for example Chesapeake Bay Program Procedure Modification Tracking Form).

10. LOG OF SIGNIFIGANT CHANGES

Procedural changes have been made over the years to address evolving water quality sampling program requirements, goals, budgetary changes, recommendations of the Analytical Methods and Quality

Assurance Work Group and other issues. (See Appendix XIV, LOG OF SIGNIFIGANT CHANGES).

The Log is a chronological list of changes to the monitoring program. The Log will be updated annually. The list is comprised of change implementation-dates and brief descriptive summaries of modified procedures. Additionally, changes in measured parameter analytical-detection-limits are summarized in tabular form.

11. REFERENCES

Alden, R.W., M.F. Lane, H. Lakkis, and J.C. Seibel. 1994. *An Assessment of the Power and Robustness of the Chesapeake Bay Program Water Quality Monitoring Program: Phase II - Refinement Evaluations*. Prepared for Virginia Department of Environmental Quality by Old Dominion University, Applied Marine Research Laboratory. AMRL Technical Report No. 965.

Bay Barometer, A Health and Restoration Assessment of the Chesapeake Bay and Watershed in 2009.
http://www.chesapeakebay.net/content/publications/cbp_50513.pdf

Chesapeake Bay Program, Analytical Segmentation Scheme, Revisions, Decisions and Rationales, 1983-2003, 2005 Addendum. December, 2005
http://www.chesapeakebay.net/content/publications/cbp_13378.pdf

Chesapeake Bay Program Monitoring and Analysis Subcommittee Tidal Monitoring and Analysis Workgroup. October 2004. *Chesapeake Bay Program, Analytical Segmentation Scheme, Revisions, Decisions and Rationales 1983-2003*. http://www.chesapeakebay.net/content/publications/cbp_13272.pdf

Eskin, R., R. Alden, R. Batiuk, S. Bieber, S. Brunenmeister, C. Haywood, R. Hoffman, R. Magnien, and M. Olson. 1993. *Guidance for the Analysis of Water Quality Trends in Chesapeake Bay*. Chesapeake Bay & Watershed Management Administration, Maryland Department of the Environment (MDE): Baltimore, MD. <http://dnrweb.dnr.state.md.us:8080/FullDisp?itemid=00011539>

Magnien, R.E, D.K. Austin, and B.D. Michael. 1993. *Chemical/Physical Properties Component: Level I Data Report (1984-1991)*. Maryland Department of the Environment (MDE): Baltimore, MD.
<http://dnrweb.dnr.state.md.us:8080/ExpertSearch?SF0=Chemical%2FPhysical+Properties+Component%3A+Level+I+Data+Report&ST0=Z>

Maryland Department of Natural Resources (DNR). 2000. *Maryland Tributary Teams - Annual Report 2000*. http://www.dnr.state.md.us/bay/tribstrat/annual_report_2000.pdf

Maryland Department of Natural Resources (DNR). 2007. *Maryland Tributary Strategy Choptank Basin Summary Report for 1985-2005 Data*.
<http://www.dnr.state.md.us/bay/pdfs/ChoptankBasinSum8505FINAL07.pdf>

Maryland Department of Natural Resources (DNR). 2007. *Maryland Tributary Strategy Lower Eastern Shore Basin Summary Report for 1985-2005 Data*.
<http://www.dnr.state.md.us/bay/pdfs/LESbasinsum8505FINAL2007.pdf>

Maryland Department of Natural Resources (DNR). 2007. *Maryland Tributary Strategy Lower Potomac River Basin Summary Report for 1985-2005 Data*.

<http://www.dnr.state.md.us/bay/pdfs/LowPotBasinSum8505FINAL07.pdf>

Maryland Department of Natural Resources (DNR). 2007. *Maryland Tributary Strategy Lower Western Shore Basin Summary Report for 1985-2005 Data*.

<http://www.dnr.state.md.us/bay/pdfs/LWSBasinSum8505FINAL07.pdf>

Maryland Department of Natural Resources (DNR). 2007. *Maryland Tributary Strategy Middle Potomac River Basin Summary Report- 1985-2005 Data*.

<http://www.dnr.state.md.us/bay/pdfs/MidPotBasinSum8505FINAL07.pdf>

Maryland Department of Natural Resources (DNR). 2007. *Maryland Tributary Strategy Patapsco/Back Basin Summary Report for 1985-2005 Data*.

<http://www.dnr.state.md.us/bay/pdfs/PatBackBasinSum8505FINAL07.pdf>

Maryland Department of Natural Resources (DNR). 2007. *Maryland Tributary Strategy Patuxent River Basin Summary Report for 1985-2005 Data*.

<http://www.dnr.state.md.us/bay/pdfs/PxtBasinSum8505FINAL07.pdf>

Maryland Department of Natural Resources (DNR). 2007. *Maryland Tributary Strategy Upper Eastern Shore Basin Summary Report for 1985-2005 Data*.

<http://www.dnr.state.md.us/bay/pdfs/UESBasinSum8505FINAL07.pdf>

Maryland Department of Natural Resources (DNR). 2007. *Maryland Tributary Strategy Upper Potomac River Basin Summary Report for 1985-2005 Data*.

<http://www.dnr.state.md.us/bay/pdfs/UPRBasinSum8505FINAL07.pdf>

Maryland Department of Natural Resources (DNR). 2007. *Maryland Tributary Strategy Upper Western Shore Basin Summary Report for 1985-2005 Data*.

<http://www.dnr.state.md.us/bay/pdfs/UWSBasinSum8505FINAL07.pdf>

U.S. Environmental Protection Agency (EPA). 1997. *Analytical Segmentation Scheme for the 1997 Re-evaluation and Beyond*. Chesapeake Bay Program, Monitoring Subcommittee, Data Analysis Workgroup, December 1997.

U.S. Environmental Protection Agency (EPA). 1997. *Chesapeake Bay Nutrient Reduction Progress & Future Directions: Nutrient Reduction Reevaluation Summary Report*. Chesapeake Bay Program, October 1997. CBP/TRS 189/97. http://www.chesapeakebay.net/content/publications/cbp_12305.pdf

U.S. Environmental Protection Agency (EPA). 1996. *Recommended Guidelines for Sampling and Analysis in the Chesapeake Bay Monitoring Program*. Chesapeake Bay Program, August 1996. CBP/TRS 148/96; EPA 903-R-96-006.

http://www.chesapeakebay.net/content/publications/cbp_13101.pdf

U.S. Environmental Protection Agency (EPA). 2008. *The State of the Chesapeake Bay and the Watershed: A Progress Report January 3, 2008*. Chesapeake Bay Program.

<http://www.chesbay.state.va.us/Presentations/January08/CBC%20Ches%20State%20of%20the%20Bay%20Update.pdf>

U.S. Environmental Protection Agency (EPA). 1991. *Chesapeake Bay Coordinated Split Sample Program Implementation Guidelines, May 1991*. Chesapeake Bay Program: Annapolis, MD. CBP/TRS 58/91. <http://nepis.epa.gov/Exe/ZyPURL.cgi?Dockey=2000VYDR.txt>

U.S. Environmental Protection Agency (EPA). 1983. *Chesapeake Bay: A Framework for Action*. Chesapeake Bay Program: Annapolis, MD. 186 p. http://www.chesapeakebay.net/content/publications/cbp_12405.pdf

U.S. Environmental Protection Agency (EPA). 1983. *Chesapeake Bay: A Profile of Environmental Change*. http://www.chesapeakebay.net/content/publications/cbp_13260.pdf

Welch, P.S. 1948. Chapter 11 in *Limnological Methods*. Blakiston: Philadelphia, PA.

APPENDIX I

MARYLAND DEPARTMENT OF NATURAL RESOURCES CHESAPEAKE BAY WATER QUALITY MONITORING PROGRAM

WATER COLUMN SAMPLING AND SAMPLE PROCESSING PROCEDURES

I. DEPTH SAMPLING PROTOCOLS

A. Hydrolab/YSI Depth Sampling Protocols (Mainstem and Tributary)

1. Take readings of temperature, specific conductance, dissolved oxygen, and pH at 0.5 m, 1.0 m, 2.0 m and 3.0 m. Thereafter, take readings at a minimum of 2.0 m intervals (subject to conditions specified in A.2. below) and at the bottom. Mainstem bottom equals total depth minus one meter, rounded up to a whole meter. Tributaries bottom equals total depth minus one meter (not rounded). Tributaries hydrographic readings are also taken at 2.0 m.
2. If the change in DO exceeds 1.0 mg/l OR if the change in specific conductance equals or exceeds 1,000 micromhos/cm over any 2.0 m interval, take readings at the 1.0 m interval between these two readings. For total depths less than or equal to 10.0 m, take readings at 1.0 m intervals.
3. If a grab sampling depth above or below the pycnocline has not been sampled for *in situ* parameters, obtain readings at this depth.
4. At a minimum, take readings at 0.5, 1.0, 3.0 m, bottom, and every odd-numbered whole meter depth.

B. Grab Sampling Depth Protocols

1. At stations where two depths are sampled, take collections at:
 - a. 0.5 m below surface.
 - b. 1.0 m above bottom to nearest 1.0 m that is at least one full m from bottom (mainstem).
 - c. 1.0 m above bottom (trib).

NOTES: If total station depth is <1.5 m, take bottom sample also at 0.5 m. Exercise caution when taking bottom samples; if disturbed bottom sediments appear to have been included in a sample, resample after sediment has settled or take sample slightly higher in the water column.

2. **Pycnocline Exists:** At stations where 4 depths are sampled and a pycnocline exists (see Section C, below), take collections at:

- a. 0.5 m below surface.
- b. 1.5 m above upper boundary of pycnocline.
- c. 1.5 m below lower boundary of pycnocline.
- d. 1.0 m above bottom to nearest 1.0 m that is at least one full m from bottom (mainstem).
- e. 1.0 m above bottom (trib).

3. **No Discernable Pycnocline:** At stations where 4 depths are sampled and there is no discernable pycnocline (see Section C, below), take collections at:

- a. 0.5 m below surface.
- b. at closest profile depth one third the distance from the surface to the bottom.
- c. at closest profile depth two thirds the distance from the surface to the bottom.
- d. 1.0 m above bottom to nearest 1.0 m that is at least one full m from bottom (mainstem).
- e. 1.0 m above bottom (tributary).

C. Pycnocline Determination (Only for Stations Sampled at four depths)

The pycnocline is a region in which the water density changes appreciably with increasing depth and thus forms a layer of much greater stability than is provided by overlying surface waters.

1. The pycnocline Calculated Threshold Value (CTV) is used to determine the boundaries of the pycnocline and to calculate the depths at which grab samples should be collected.

The pycnocline Calculated Threshold Value (CTV) is derived using the equation below.

$$CTV = \frac{C_b - C_s}{D_b - D_s} \times 2$$

Where:

C_b = bottom conductivity (micromhos/cm),

C_s = surface conductivity (micromhos/cm),

D_b = depth of bottom conductivity measurement (m),

D_s = depth of surface conductivity measurement (m),

CTV = calculated threshold value (micromhos/cm)

ex. bottom conductivity: 15800 micromhos/cm
surface conductivity: 9500 micromhos/cm
depth of bottom conductivity measurement: 14.6 m
depth of surface conductivity measurement: 0.5 m

$$CTV = \frac{15800 - 9500}{14.6 - 0.5} \times 2 = 893.6 \text{ micromhos/cm}$$

2. If the Calculated Threshold Value is greater than 500 micromhos/cm, a pycnocline exists with boundaries at the first and last depths where the change in conductivity is greater than the CTV. For example, continuing with the CTV value: 893 derived in the example calculation above, and evaluating conductivity readings moving up in the water column from the bottom, the lower boundary of the pycnocline occurs at first depth where the change in conductivity from that measured at the preceding depth exceeds 893. Moving upward in the water column, the upper boundary of the pycnocline occurs at last depth where the change in conductivity from that measured at the preceding depth exceeds 893. Samples will be taken as described in section B. 2., above.

NOTE: In the rare cases when the sample is theoretically 'below the bottom' or 'above the surface', use following procedures. If the below pycnocline (BP) sample is determined to be below the bottom sample, collect the BP sample at the bottom sample depth. If the above pycnocline (AP) sample is determined to be above the surface sample, collect the AP sample at 0.5 m.

3. Take samples as described in section B. 3. (No Discernable Pycnocline), above, if either of the following two conditions are present:
 - a. the CTV is less than 500 micromhos/cm.
 - b. the CTV is equal to or greater than 500 micromhos/cm BUT no depth interval exceeds that CTV.

NOTES: Upper and lower boundaries of the pycnocline may be the same point. If this is the case, collect the Above Pycnocline sample 1.5 m above the upper pycnocline limit and collect the Below Pycnocline sample 1.5 m below the lower pycnocline limit.

D. Hydrogen Sulfide Protocols

1. For the mainstem only, when there is an odor of hydrogen sulfide present in the bottom sample or the below pycnocline sample, perform a Hach Kit test for hydrogen sulfide presence on the bottom and/or below pycnocline sample(s).
2. Immediately upon collection of the sample that meets the requirements in D. 1. above, transfer a portion of sample from the plastic sample container to the 25 ml Hach Test

glass container (from the Hach Hydrogen Sulfide Test Kit, Model HS-6), for hydrogen sulfide determination.

3. Immediately perform test for H₂S presence following instructions in Hach Hydrogen Sulfide Test Kit. Record results on the Cruise Report.

E. Secchi Depth

Measure water transparency using Secchi depth. Determine Secchi depth in meters to the nearest 0.1 meter using a 20-cm standard Secchi disc lowered into the water column with a calibrated rope. Make observations on the shady side of the boat. Do not wear sunglasses while taking a Secchi reading.

F. Photosynthetic Active Radiation (PAR)

PAR readings (in $\mu\text{Moles/square meter/second}$) are taken in the field in order to calculate a light attenuation coefficient. Take PAR measurements with a LICOR quantum meter (Model LI-1000 Data Logger) with an attached underwater probe (Model LI-192SA). The probe is a flat, upwardly-directed probe.

Begin a vertical profile of light penetration by taking an initial reading with the sensor just below the surface of the water (0.1 m). Take subsequent measurements at either 0.25-m or 0.50-m intervals depending on the turbidity of the water column, (taking shallower measurements in more turbid water). Continue to take readings until a value less than ten percent (10 %) of the surface reading (0.1 m) is attained. Once the readings stabilize, allow at least five readings to flash on the display before recording the data reading for a specific depth. Record in the data logger the mean of the previous five readings that appear on the instrument display. Alternatively, the mean value may be recorded on the field datasheet.

The light measurements made for each profile are log-scale regressed against depth to determine the compensation depth, i.e., the depth of penetration of one percent (1 %) of the surface PAR. The compensation depth is used in computing the integrated carbon production for that water column. When light profiles are not available, the secchi disk depth is used to calculate the compensation depth. Over the study period, 1984-1996, a regression has been made between the secchi depth and the compensation depth for the same water column (for those stations where both secchi data and LICOR data are taken). By using this regression, a compensation depth can be estimated from a secchi depth.

The following table lists the parameters measured and the associated qualifiers to be recorded for light attenuation:

FIELD	DESCRIPTION
SOURCE (PK, FK)	Code identifying agency or contractor that measured the data
PROJECT (PK, FK)	Agency monitoring project code
STATION (PK, FK)	CBP station name
SAMPLE_DATE (PK)	Date on which the PAR readings were taken
SAMPLE_TIME (PK)	Time at which the PAR readings were taken
DEPTH (PK)	Depth at which the PAR readings were taken (meters)
EPAR_S	PAR reading ($\mu\text{M}/\text{m}^2/\text{s}$) taken at the boat just before or during the measurement of PAR readings at depth
EPARU_Z	PAR reading ($\mu\text{M}/\text{m}^2/\text{s}$) taken at depth (up sensor)
UNITS	Units for PAR ($\mu\text{M}/\text{m}^2/\text{s}$)
METHOD	Method code identifying the field measurement procedure
COMMENTS	Comments related to the collection of PAR readings

II. SAMPLE COLLECTION

- A. Lower submersible pump to desired depth.
- B. Allow hose to flush completely before taking sample (flush time is pump dependent).
- C. Rinse pre-marked sample container (plastic container) and cap three times with sample water.
- D. Collect sample, cap the plastic container, and begin water sample processing and appropriate storage/preservation.
- E. Any time a field duplicate is required (whenever indicated on the station lab data sheet), follow the procedures in the section "Split-sample collection method for field duplicates".
- F. Enter on lab and field sheets all identifying information pertinent to samples collected.

III. SPLIT-SAMPLE COLLECTION METHOD FOR FIELD DUPLICATES

A. Samples for field duplicates are generated approximately one for every 20 samples collected.

B. Collect sample as in section II. A and II. B above.

C. Rinse duplicate collection container three times and fill with sample water.

NOTE: Collection container must be large enough to generate two complete samples. If more than one gallon of sample is needed for samples, fill a plastic bucket (2.5 to 5 gallon) with sample water and draw all samples from the bucket, taking care to maintain a homogeneous mixture as water is drawn from the duplicate container.

D. Begin water sample processing and appropriate storage/preservation.

E. Enter all identifying information pertinent to samples collected on lab and field sheets.

NOTE: Lab and field sheets must have a replicate number entered for each duplicate generated.

IV. FILTRATION, PROCESSING AND STORAGE OF CHLOROPHYLL SAMPLES

A. For every depth sampled, clean bell and frit with deionized water (DI-H₂O; stored in a high density polyethylene container) generated at the Field Office. Set up bell and frit for filtering. Ensure that there is a trap in line between the manifold and the vacuum source.

B. Place a Whatman GF/F glass fiber filter pad (pore size = 0.7 μm) on the filter frit. When handling the pad, use clean forceps.

C. Mix sample thoroughly by agitating plastic sample container vigorously, then rinse graduated cylinder three times with sample.

D. Fill graduated cylinder with sample and filter desired volume through filtration unit. Keep the vacuum below 10 inches of Hg. Filter sufficient volume of sample (100 - 1500 ml) to solidly color the filter pad. Do not suck the filter dry. In order to avoid cell damage, decrease the amount of vacuum as the final volume approaches the level of the filter and release the vacuum as the last of the water is pulled through the pad. Record the total volume filtered.

E. Add approximately 1 ml of MgCO₃ suspension (Laboratory grade from Fisher Scientific prepared in a 1.0 g MgCO₃ to 100 ml of DI-H₂O ratio) to the last 25 ml of sample in the filtration bell. This is equivalent to less than 1 mg of MgCO₃ per 15 ml extract.

NOTE: Filtrate for nutrient analysis should not be saved from this filtration.

F. Remove filter pad with forceps, fold filter in half with sample inside, place in pre-marked foil square, and carefully fold square in thirds, horizontally and vertically, to seal filter inside. Be sure forceps do not touch sample residue on the filter pads, because the sample will adhere to the forceps.

G. Be sure that foil square is marked with date, station, sample layer code, volume of sample filtered, sample number, and "CHLA".

H. Place sample FOIL into pre-marked zip-lock plastic bag. Store bag of chlorophyll samples in Research Vessel freezer for mainstem samples or an ice chest for tributary samples. If samples are stored on ice, place in freezer on return to Field Office.

I. Record sample identifier, date, volume filtered (L), depth (m), layer, start time, end time, study code, submitter code, data category code, field scientist sign off, and replicate number, if necessary, on chlorophyll calculation sheet. This sheet is submitted to the laboratory with the samples.

NOTE: Filter pad with chlorophyll sample should be exposed to as little direct sunlight as possible. Store in foil as soon as possible.

NOTE: An additional chlorophyll pad is generated every 10 samples to provide a replicate for the lab. The samples requiring a second pad are noted on the foil square as "2 pads". Filter a second pad of identical volume and place in the foil square alongside (not overlapping) the first pad.

V. FILTRATION, PROCESSING AND STORAGE FOR PARTICULATE FRACTIONS (PARTICULATE P, C, N AND TOTAL SUSPENDED SOLIDS)

A. Processing and storage - PC, PN:

For each depth sampled, thoroughly clean all bells and frits with DI-H₂O, set up filter apparatus, filters (two pre-combusted 25 mm GF/F filters, pore size = 0.7 μm), and bells for filtering. Filter 10-200 ml through each filter. Filter enough of the sample to leave noticeable color on the filter pad. Make sure filter is sucked dry. Using forceps, fold each filter in half. Place both filters in a foil square labeled with date, PC/PN-CBL sample number, station, sample layer, and volume filtered. Fold as described in IV.F. and then place folded foil in zip-lock bag, and put in freezer (large boats) or on ice (small boats).

B. Processing and storage - PP, TSS:

For each depth sampled, thoroughly clean all glassware with DI-H₂O. Set up one flask, filter (one pre-weighed and numbered 47 mm GF/F filters placed with the pad number facing down), and bell for filtering. After rinsing a graduated cylinder three times with

sample water, measure 50 - 200 ml of sample into filter bell. Use the filtrate as an equipment rinse and discard. Note amount filtered through the filter. Then filter enough additional (another 50 -300 ml) to leave a noticeable color on the filter pad. Use this filtrate as required for filtered parameter analysis.

After collecting filtrate, make sure filter is sucked dry, and rinse three times with 10 ml rinses of water, sucking dry after each rinse. Using forceps, fold filter in half. Place filter in a foil square labeled with date, TSS/PP-CBL sample number, station, sample layer, and volume filtered. Fold as described in IV.F. and write sample number on foil with Sharpie permanent marker to facilitate post-combustion sample identification. Place foil square in zip-lock bag, and put in freezer (large boats) or on ice in (small boats).

NOTE: An additional TSS/PP pad is generated every 10 samples to provide a replicate for the lab. The samples requiring a second pad are noted on the foil square as "2 pads". Filter a second pad of identical volume and place in the foil square alongside (not overlapping) the first pad.

Ten percent of the filters that CBL supplies for field filtering TSS must be pre-rinsed 3 times with deionized water, dried at 103-105 °C for 1 hour, then weighed, re-dried and reweighed until a constant weight is obtained. (Alternatively, purchase certified, pre-weighed filters.)

C. Processing and storage - VSS:

VSS samples are collected from the surface sample at pre-determined stations. Thoroughly clean all glassware with DI-H₂O. Set up one flask, filter (1 pre-weighed, pre-combusted and numbered 47 mm GF/F filters, placed wrinkled side up), and bell for filtering. The number for the pad is written on the individual Petri dish that the pad came in. You must write this number on the foil square label. After rinsing a graduated cylinder three times with sample water, measure 50 - 200 ml of sample into the filter bell. Use the filtrate as an equipment rinse and discard. Note amount filtered through the filter. Then filter enough additional (another 50 -300 ml) to leave a noticeable color on the filter pad. You may use this filtrate as required for filtered parameter analysis. After collecting filtrate, make sure filter is sucked dry, and rinse three times with 10 ml rinses of water, sucking dry after each rinse. Using forceps, fold each filter in half. Place the filter in a foil square labeled with date, VSS-CBL sample number, pad number, station, sample layer, and volume filtered. Fold as described in IV.F. and write sample number on foil with Sharpie permanent marker to facilitate post-combustion sample identification. Place foil square in the TSS/PP zip-lock bag, and put in freezer (large boats) or on ice in (small boats).

VI. FILTRATION, PROCESSING AND STORAGE FOR "DISSOLVED" FRACTIONS (NH₄, NO₂, NO₃, PO₄, Si, TDN, TDP, DOC)

A. This filtrate always comes from particulate phosphorus/TSS filters, section V, above. Use GF/F filters, and pre-rinse the filter and flask with at least 50 ml of sample water. If sample is taken from particulate filtration, collect it prior to rinsing the pads with DI-H₂O.

B. Processing and storage - NH₄, NO₂, NO₃, PO₄, Si:

Triple rinse, with filtrate, three like-numbered autoanalyzer (AA) vials and caps. Fill approximately 7/8 full, allowing for sample expansion upon freezing. Place the AA vials in a rack in the freezer. A fourth vial is collected for silica at a subset of stations. The silicate vial should be stored at 4 °C in the R/V refrigerator. On small boats, keep all samples iced in a cooler, then freeze all but silica upon return to Field Office.

NOTE: The number on all vials and tubes is the CBL sample number and should match the number on TSS/PP and PC/PN foil pouches for each particular sample.

C. Processing and storage - TDN, TDP:

Triple rinse test tube, cap, and 10 ml graduated cylinder with filtrate. Be sure number on test tube corresponds to the number on the vials and sample number. Use 10 ml graduated cylinder to measure EXACTLY 10.0 ml of filtrate. (The 10 ml graduated cylinders will be calibrated annually by the Chesapeake Biological Laboratory.) Shake any remaining rinse water out of the test tube. Pour into pre-rinsed test tube and cap sample, then freeze sample in test tube rack on large boats. On small boats, keep sample on ice in cooler, then freeze upon return to Field Office.

D. Processing and storage - DOC (subset of Bay Tributary stations only; not measured for Mainstem stations): Triple rinse 50 ml test tube and cap with filtrate. Fill the 50 ml test tube 3/4 full with filtrate and cap sample, then freeze in test tube rack. On small boats, keep sample on ice, then freeze at Field Office.

VII. ROUTINE MAINTENANCE OF FILTRATION UNITS AND CONTAINERS FOR MAINSTEM CRUISES AND AFTER RETURNING FROM FIELD

A. After each day's sampling on mainstem cruises, filtration units, flasks, frits and graduated cylinders should be cleaned with a non-phosphorus liquid soap, rinsed with tap water three times, then rinsed with 10% HCL (prepared from concentrated HCL from Fisher Scientific diluted with DI-H₂O), tap rinsed, and finally rinsed three times with DI-H₂O. All open flasks, filtration units and graduated cylinders should then be covered to prevent contamination if filtering is not to begin immediately. The filtration unit used for chlorophyll *a* filters should be washed with soap and rinsed with tap and DI water and not be rinsed with 10 percent HCL.

B. Big boat units are cleaned at the end of each day's sampling. Small boat or land run units are rinsed with DI-H₂O at end of each day's use and cleaned weekly, or after processing 20 to 30 samples.

APPENDIX II

MARYLAND DEPARTMENT OF NATURAL RESOURCES CHESAPEAKE BAY WATER QUALITY MONITORING PROGRAM

FIELD SHEET AND LAB SHEET- DOCUMENTATION AND PROCEDURES

The following information reviews the conventions for filling out the Field Sheets, and Lab Sheets (nutrient, suspended solids and chlorophyll volume sheets) used for the Chesapeake Bay Monitoring Program.

Refer to the examples of Field Sheets A and B and Lab Sheets at the end of this appendix.

Beginning in 2009, chlorophyll analysis by the Maryland Department of Health and Mental Hygiene ceased and the Chesapeake Bay Laboratory, Nutrient Analytical Services Laboratory began analyzing chlorophyll samples.

The codes used for this program are listed in Appendix XI.

NOTE: Leave blank any boxes on the Field Sheet for which data are not collected.

Field Sheet A:

The Field Sheets are sent along with a Cross Reference Sheet from the Field Office to the Data Management Unit at the DNR Tawes Building. (See Appendix III for information on the Cross Reference Sheet.) The Field Office must provide the following information on the Field Sheet.

1. Sequence Number (boxes 3-9, upper right hand corner)

The following convention has been used to designate the 7-digit sequence number for the mainstem, where YY is last two digits of year, NNN is the cruise number (that year), and SS is the station order for that week's cruise:

MAINSTEM Convention YYNNNSS

For example, sequence number 8401204 is the 12th cruise in 1984 at station 4 for that weeks cruise.

The following convention has been used to designate the 7-digit sequence number for the tributary sampling, where YY is last two digits of year, MM is month, T is for tributary, P is for Patuxent, M is for Potomac, C is for CORE, and XX is arbitrary ordering number:

TRIB Convention YYMMTXX
PXT Convention YYMMPXX
POT Convention YYMMMXX
CORE Convention YYMMCXX

For example, 9603P05 is the fifth field sheet for a March Patuxent cruise in 1996.

NOTE: The ordering numbers continue to increase throughout the month. For example, the first Patuxent cruise in April may have sheets numbered 01-14 and the second Patuxent cruise for that same month would have sheets numbered 15-28.

2. Sampling Station Number (boxes 10-18)

Enter the appropriate Chesapeake Bay Program station location (e.g.MWT5.1, MET5.2) beginning with the box numbered 10. Put only one character (including decimal points) per box.

3. Start Date (boxes 20-25)

Enter the start date beginning with year, month, day.

4. Start Time (boxes 27-30)

Enter the start time of the sampling effort at a station location in military time.

5. End Date (boxes 32-37)

If the end date for a particular station is the same as the start date, the end date boxes can be left blank.

6. End Time (boxes 39-42)

Enter the end time of the sampling collection effort at a station location in military time. The end time is the time at the end of *in situ* data collection (meter readings).

7. Number of Samples (boxes 44-45)

Enter the number of samples taken (including duplicates) at the station location. Routinely, there are two to five samples collected at stations for the Chesapeake Bay Monitoring program.

8. Submitter Code (boxes 47-48)

The submitter codes specify the collection group and the lab that will perform the analyses.

9. Data Category Code (boxes 50-51)

The data category codes, which are listed in Appendix XI, specify the code for the type of sample being collected. For example, for the Chesapeake Bay Program Main Bay Sampling, the code is 'MB' - Chesapeake Bay Monitoring Sample- MD. Main Bay".

10. Total Depth (M) (boxes 53-55)

Enter the total depth at the station in meters to the nearest 0.1 m for tributary stations and to the nearest 0.5 m for mainstem stations.

11. Study Code (boxes 57-58)

The study codes, which are listed in Appendix XI, indicate the type of monitoring program. For example, '01' is the study code for the "Chesapeake Bay Monitoring Program - Main Bay".

12. Sample Method (line #2, box 10)

The sample method codes, which are listed in Appendix XI, indicate the sample method used for the sampling effort. For example, '1' is the code for 'Grab Samples'.

Note: If no water samples are collected (not even bacti samples), the code is '7'.

13. Air Temperature degrees Celsius (line #2, boxes 11-14)

Air temperature is reported in degrees Celsius to the nearest 0.5 degrees. The value is recorded in boxes 12-14. There is a box (#11) to indicate a plus (+) or minus (-) value. Leave this blank if temperature is greater than or equal to zero; write in a minus (-) sign if it is below zero.

14. Tide State (line #2, box 18)

Tide state codes are listed in Appendix XI. For example, the code 'E' specifies an ebb tide.

15. Weather Code Yesterday (line #2, boxes 20-21)

Enter the code for yesterday's weather in these boxes. The weather codes with their corresponding descriptions are listed in Appendix XI. Additional weather information can be included in the comments section if appropriate.

16. Weather Code Today (line #2, boxes 23-24)

Enter the code for current weather (while at station) in these boxes. Additional weather information can be included in the comments section if appropriate.

17. Percent Cloud Cover (line #2, boxes 25-27)

Enter the amount of cloud cover in these boxes. Percent Cloud Cover is reported as values from 00 to 100 percent. Numbers must be **right** justified, e.g., 5 (not 5).

18. Wind Direction (line #2, boxes 28-30)

Record wind direction using the codes:

- N - Northerly direction
- S - Southerly direction
- E - Easterly direction
- W - Westerly direction

Record wind direction in boxes 28-30 using up to three letters to designate the prevailing conditions. An example of wind direction would be 'north by north east' and the codes in boxes 28-30 would be 'NNE'. If only one or two letters are needed to designate the conditions, use the boxes beginning with box #28 for the codes. Letters must be **left** justified, e.g., S W (**not** S W)

19. Wind Velocity (knots) (line #2, boxes 31-32, 33-34)

Record wind velocity in knots in boxes 31-32, 33-34. Record the minimum (or lower range) velocity in boxes 31-32; record the maximum (or upper range) velocity in boxes 33-34. For example, if the wind is blowing from 10 to 20 knots, the minimum wind velocity is '10,' and the maximum wind velocity is '20.' If only one number is needed to designate the wind velocity conditions, enter the identical numbers in both the boxes for minimum velocity as well as in the boxes for maximum velocity. Beaufort wind force scale values may be used when recording wind velocity. 01-03, 04-06, 07-10, 11-16, 17-21, 22-27, and 28-33.

number	Wind speed				Mean wind speed (kt / km/h / mph)	Description	Wave height		Sea conditions	Land conditions
	kt	km/h	mph	m/s			m	ft		
0	0	0	0	0-0.2	0 / 0 / 0	Calm	0	0	Flat.	Calm. Smoke rises vertically.
1	1-3	1-6	1-3	0.3-1.5	2 / 4 / 2	Light air	0.1	0.33	Ripples without crests.	Wind motion visible in smoke.
2	4-6	7-11	4-7	1.6-3.3	5 / 9 / 6	Light breeze	0.2	0.66	Small wavelets. Crests of glassy appearance, not breaking	Wind felt on exposed skin. Leaves rustle.
3	7-10	12-19	8-12	3.4-5.4	9 / 17 / 11	Gentle breeze	0.6	2	Large wavelets. Crests begin to break; scattered whitecaps	Leaves and smaller twigs in constant motion.
4	11-16	20-29	13-18	5.5-7.9	13 / 24 / 15	Moderate breeze	1	3.3	Small waves.	Dust and loose paper raised. Small branches begin to move.
5	17-21	30-39	19-24	8.0-10.7	19 / 35 / 22	Fresh breeze	2	6.6	Moderate (1.2 m) longer waves. Some foam and spray.	Smaller trees sway.
6	22-27	40-50	25-31	10.8-13.8	24 / 44 / 27	Strong breeze	3	9.9	Large waves with foam crests and some spray.	Large branches in motion. Whistling heard in overhead wires. Umbrella use becomes difficult.
7	28-33	51-62	32-38	13.9-17.1	30 / 56 / 35	Near gale	4	13.1	Sea heaps up and foam begins to streak.	Whole trees in motion. Effort needed to walk against the wind.

20. Secchi (M) (line #2, boxes 35-38)

Record Secchi depth in meters to the nearest 0.1 meter.

21. Flow Value (line#2, boxes 39-46)

Note that flow is not recorded in regular scientific notation, but is recorded as follows. Box #39 is the flow basis code, where:

- 1 = measured in cubic feet per second (CFS)
- 2 = estimated in cubic feet per second (CFS)
- 3 = measured in million gallons per second (MGS)
- 4 = estimated in million gallons per second (MGS)
- 5 = measured in gallons per day (GPD)
- 6 = estimated in gallons per day (GPD)

Boxes 40-44 are for the five-digit mantissa and box 45 is for the exponential value in base 10. These boxes are to be left blank at boat or other stations where flow is not recorded.

For example, estimated flow $4.5_{\text{cfs}} = 2.450001$, where "2" indicates that the flow is estimated in cubic feet per second, "45000" indicates that the mantissa is 4.5000, and "1" indicates multiply the mantissa by 10^1 .

The final box, #46, is for greater or less than (G or L).

Note: Flow value is not a required parameter and is seldom measured.

22. Senior Scientist (line #2, boxes 47-49)

The three initials of the senior scientist (the scientist in charge of the sampling effort for that day) are entered in these boxes.

23. DO Method (line #3, box 50)

The codes for the dissolved oxygen (DO) methods are listed in Appendix XI. Method code values currently used are: 'H' for Hydrolab Clark Cell; 'L' for Hydrolab LDO; and 'R' for YSI ROX.

24. Equipment Set Unit # (line #3, boxes 51-52)

The numbers assigned to equipment packages is recorded in these boxes.

25. Probe Number (line #3, boxes 53-54)

Enter the Hydrolab or YSI probe number in these boxes. If using spares, enter the same equipment letter in probe number box and record spare number in comments boxes.

The text of the label over boxes 53-54 on the field sheets used on Patuxent River project is “LiCor Number” instead of “Probe Number”. (See Patuxent field sheet example at the end of this appendix).

26. Flow/Tide Unit Number (line #3, boxes 55-56)

Enter in boxes 55-56 the number of the meter used to measure the flow value. These boxes should be left blank if flow was not recorded for the station.

The text of the label over boxes 55-56 on the field sheets used on Patuxent River project is “LiCor Method” instead of “Flow/Tide Unit Number”. (See Patuxent field sheet example at the end of this appendix).

27. Wave Height (M) (line #3, boxes 57-59)

Wave height is recorded in meters.

28. Upper Pycnocline Limit (M) (line #3, boxes 60-62)

The calculated value for the upper pycnocline limit is recorded in meters and is entered in these boxes. If no pycnocline exists, leave these boxes blank.

29. Lower Pycnocline Limit (M) (line #3, boxes 63-65)

The calculated value for the lower pycnocline limit is recorded in meters and is entered in these boxes. If no pycnocline exists, leave these boxes blank.

30. Scientist Signoff (line #3, boxes 66-68)

A DATA SHEET WITH NO SCIENTIST SIGNOFF WILL NOT BE SENT TO THE DATA ENTRY SERVICE.

The scientist who checked over the field sheet for:

- the correct codes
- the correct date
- the correct start time and end time
- the correct sampling station number
- reasonable values for the parameters
- the values for the parameters are entered on the sheet properly

enters his/her initials in these boxes.

Ideally, the individual who initiates the signoff is a separate individual from the one who enters the values on the data sheet. This process of using two separate individuals whenever possible, one to enter the values onto the sheet and one to check over the values that are entered, can help minimize transcription errors and correct aberrations in protocol. However, when a scientist works alone, the same scientist who enters the values checks the sheets before leaving the station.

31. Comments (beginning on line #3 - #5)

Any comments that are necessary to fully describe the sampling effort should be entered in the Comment section. Use one box for each character, decimal point, or period.

31. Replicate Number (line #6, box 11)

If the values for specific conductance, water temperature, DO, etc. are repeated for a single depth and are entered on the field sheet, indicate this by entering the replicate number (from 2 to 9) in these boxes. A blank in box #11 defaults to 01.

32. Depth (M) (line #6, columns 13-15)

Enter the depth at which the suite of parameters is measured (in meters).

33. Water Temperature degrees C (line #6, columns 17-20)

The water temperature is recorded in degrees Celsius. The value is recorded in columns 18-20; column #17 is to indicate a minus (-) value. Leave this column blank if temperature is greater than or equal to zero; write in a minus (-) sign if it is below zero.

34. Field pH (line #6, columns 22-25)

Enter values for field pH in these columns (round pH to the nearest tenth).

35. Value Corrected (line #6, column 27)

Use one of the three codes for DO correction in Appendix XI.

36. DO (mg/l) (line #6, columns 28-32)

Enter the DO value in columns 29-32. Column #28 is used to indicate greater than (G) or less than (L) values. A less than (L) in column #28 indicates that the value for DO in columns 29-32 is the detection limit for the DO probe. The code "A" may be used in the column designated for G/L when an adjustment has been made for drift found in the post calibration of the meter. The code "E" may be used in the column designated for G/L when the value in columns 29-32 is considered an "estimate" rather than a value that falls within the stated error range. Estimated values may reflect variability at that water depth (i.e., in the mixing zone) or they may reflect an estimate that appears reasonable to the analyst but they have some reservations; see the comments section for notes explaining the "E" value.

37. Specific Conductance (micromhos/cm at 25EC) (line #6, columns 34-39)

Enter the values for specific conductance in columns 35-39. Use column #34 to indicate greater than (G) or less than (L) values. The code "A" may be used in the column designated for G/L when an adjustment has been made for drift in post-calibrating the meter. The code "E" may be used in the

column designated for G/L when the analyst considers the value in columns 35-39 to be credible, but outside normal measurement variability.

NOTE: Hydrolab reports microsiemens/cm. Since specific conductance is reported at 25EC, microsiemens/cm=micromhos/cm at 25EC.

38. Salinity (ppt) (line #6, columns 40-43)

Enter a value for salinity in columns 40-43.

39. Lab Login Section (line # 6, columns 49-63)

This section is used to record the number of replicate water samples which were collected, the depth at which the samples were collected, the layer from which the samples were collected, and the bottle numbers that the samples were assigned. (Note the designation AP and BP indicate above and below pycnocline only if a pycnocline actually was present. If no pycnocline they indicate below surface and above bottom at 1/3, 2/3 depths.)

A. Replicate (line #6, column 49)

If more than one sample is collected for analysis at an identical depth, indicate this by entering a 1, 2, 3, etc. to differentiate the replicates. Leaving this column blank results in a default to 1.

B. Sample Depth (M) (line #6, columns 50-52)

Record the depth in meters at which the samples were collected. Meter readings are required for this depth.

C. Layer Code (line #6, columns 53-54)

Indicate at which layer the samples were collected. The layer codes are listed in Appendix XI. Enter layer code (S=surface, B=bottom, AP=above pycnocline, BP=below pycnocline). Left justify single-character codes (i.e., codes with only one letter).

D. Bottle Numbers (line #6, columns 55-63)

Enter the bottle numbers assigned to the samples. Up to nine alphanumeric characters can be used. If less than nine characters are used, left justify. These bottle numbers are the same as those indicated on lab sheets.

40. Pycnocline Threshold Calculations

This section is used as a worksheet to calculate the pycnocline. The following symbols are used in the formula.

Δ = Delta (used to indicate change)

\bar{X} = Mean

$\bar{X} \Delta M$ = indicates mean change (Delta) per meter

41. Date entered (entered by keypunch at bottom left of sheet)

Date returned from keypunching (entered by keypunch at bottom of sheet).

42. Page ___ of ___ (bottom right of sheet)

If only one sheet is generated at a station, leave this blank; the default value is 'page 1 of 1.' When two sheets are generated at one station, enter in this area 'page 1 of 2' for the first sheet generated, and 'page 2 of 2' for the second sheet generated. The second sheet generated at a sampling location is Field Sheet B, discussed next.

Field Sheet B:

Use Field Sheet B when two field sheets are generated at one sampling location.

1. Sequence Number

Use the same convention (described above) for sequence number for this field sheet. The second sheet generated at one location must have the identical sequence number as the first sheet. The two sheets should not be stapled together.

2. Top Half of Form

The top of this form only has lines for Sampling Station Number, Date, Start Time, and End Time (the boxes have been replaced with lines). Enter this information to alleviate the problem of mismatched or unidentifiable sheets.

3. Bottom Half of Form

The bottom half of this form is the same as the field sheet previously discussed. There is no need to enter information on the second sheet for the Lab Login or pycnocline calculation.

Lab Sheet (also called filtering volume sheet; for nutrient, suspended solids and chlorophyll analyses)

When nutrient, suspended solids and chlorophyll samples are collected, a lab sheet is generated, and serves as a Sample Transfer Sheet. The lab sheet lists multiple stations that contain information for several samples on one sheet. Information on the sheet includes the sample number, layer, depth, time, salinity, and volume sampled for each set of parameters (e.g., TSS/PP, PC/PN, CHLA). This sheet is filled out by field personnel and must accompany the samples to CBL. CBL produces electronic files which are for uploaded into MD DNR Water Quality Data Management system.

1. Cruise Identification Number (Mainstem stations only)

Enter the cruise identification number in the space provided (year and cruise number, e.g., 97018 for 1997, Cruise Number 18).

2. Date

Enter the date in the space provided. It does not need to be in any specific format.

3. Scientist Signoff

The scientist must check the sheet for completeness and accuracy, and then initial in the signoff space.

4. Station, Sample Number, Layer

Enter the station, sample number, and layer code (S=surface, B=bottom, AP=above pycnocline, BP=below pycnocline), if not preprinted.

5. Sampling Time (column 5)

Enter the sampling time in military time in column 5.

6. Salinity (column 6)

Enter the salinity in parts per thousand (ppt) in column 6.

7. Vol. (ml) (final 3 or 4 columns)

In the final 3 or 4 columns, enter the volume sampled for each set of sample parameters (e.g., TSS/PP, PC/PN, VSS, CHLA) in milliliters.

Sequence Number
 0600201
 3 (punch in 3-9 all cards) 9



Maryland Department of Natural Resources
 Field Sheet

Project Name: Main Bay-Smith Point
 Submitter: AFO-Fabian

Sampling Station Number: Year 060207 Day 25 Weather code Today 110 Weather code Yesterday 110 Tide State E Wave Height (M) 0.40 Wave Pycnocline Limit 60 61 62 Upper (M) 60 61 62 Pycnocline Limit 63 64 65 Lower (M) 63 64 65 Wind Direction W Wind Velocity (Knots) Min. 07 Max. 10 End Time 1115 Number of Samples 04 Submitter code 79 Category Code MB Total Depth M 27.5 Exp G/L 44 45 46 47 48 49 50 51 52 53 54 55 56 57 58 59 60

Rep No. 13 14 15 16 17 18 19 20 21 22 23 24 25 26 27 28 29 30 31 32 33 34 35 36 37 38 39 40 41 42 43 44 45 46 47 48 49 50 51 52 53 54 55 56 57 58 59 60 61 62 63 64 65 66 67 68 69 70 71 72 73 74 75 76 77 78 79 80

Method DO H DO H R R
 Depth M 13 14 15 16 17 18 19 20 21 22 23 24 25 26 27 28 29 30 31 32 33 34 35 36 37 38 39 40 41 42 43 44 45 46 47 48 49 50 51 52 53 54 55 56 57 58 59 60 61 62 63 64 65 66 67 68 69 70 71 72 73 74 75 76 77 78 79 80

Water Temp. °C 57 57 57 57 56 56
 Field pH 8.2 8.2 8.2 8.2 8.3 8.2
 DO mg/l 11.9 11.8 11.9 11.8 12.0 12.0
 Conductivity Microhos/cm 2170 2170 2170 2170 2180 2180
 Salinity ppt 13.0 13.0 13.0 13.0 13.0 13.0
 Sample Depth M 0.5 0.5 0.5 0.5 0.5 0.5
 Layer Code S S B A P A P
 Bottle Number #1 #2 #3 #4
 Comments: 10

Rep No.	Depth M	Water Temp. °C	Field pH	DO mg/l	Conductivity Microhos/cm	Salinity ppt	Sample Depth M	Layer Code	Bottle Number	Weather Codes
1	0.5	57	8.2	11.9	2170	13.0	0.5	S	#1	10 = none 11 = drizzle 12 = rain 13 = rain, heavy 14 = squally 15 = frozen precipitation
1	1.0	57	8.2	11.8	2170	13.0	0.5	B	#2	Wind Velocity: 1-3 slight ripple 4-6 small waves, not breaking 7-10 scattered whitecaps 11-16 numerous whitecaps 17-21 moderate waves, many whitecaps 22-27 large waves, many whitecaps 28-33 sea heaps get off the water! NOW
2	2.0	57	8.2	11.9	2170	13.0	0.5	A	#3	
3	3.0	57	8.2	11.8	2170	13.0	0.5	P	#4	
5	5.0	56	8.3	12.0	2180	13.0	0.5			
7	7.0	56	8.2	12.0	2180	13.0	0.5			
9	9.0	56	8.2	11.7	2180	13.0	0.5			
10	10.0	56	8.2	11.5	2180	13.1	0.5			
11	11.0	58	8.1	10.7	2170	14.1	0.5			

Wave Height: 0.00 = flat calm, 0.05m = slight ripple, 0.20m = ripple - 1 ft, 1.50m = 4-6 ft
 Pycnocline Threshold Calculation
 Bottom Cond - Surface Cond = cond change (Δ) = 31.70 - 31.00 = 0.70
 Δ cond / (depth of bottom cond reading - 0.5) = X Δ/M = 0.70 / 0.5 = 1.4
 X Δ / M x 2 = Threshold value = 2.8

Field Sheet A example

Sequence Number
 0600201
 3 (punch in 3-9 all cards) 9



Maryland Department of Natural Resources
 Field Sheet

Project Name: Main Bay-Smith Point
 Submitter: AFO-Fabian

Sample Station Number: CB5.3 DATE: 2-7-06 Start Time: 1055 End Time: 1115

Rep No.	Depth M	Water Temp. °C	Field pH	D.O. mg/l	Conductivity		Salinity ppt	Sample Depth M	Layer Code	LAB LOGIN Bottle Number
					µS/cm	G/L				
11	12.0	59	8.00	9.60	299.00	30.00	18.50			
	13.0	59	7.90	9.60	300.00	30.10	18.60			
	14.0	59	8.00	9.60	301.00	30.20	18.70			
	15.0	59	7.90	9.50	303.00	30.50	18.90			
	16.0	59	7.90	9.50	313.00	31.40	19.40			
	17.0	60	7.90	9.50	314.00	31.60	19.70			
	18.0	60	8.00	9.50	317.00	31.70	19.70			
	19.0	61	8.00	9.60	317.00	31.70	19.70			
	20.0	61	8.00	9.60						
	21.0	61	8.00	9.60						
	22.0	61	8.00	9.60						
	23.0	61	8.00	9.60						
	24.0	61	8.00	9.60						
	25.0	61	8.00	9.60						
	26.0	61	8.00	9.60						
	27.0	61	8.00	9.60						
	28.0	61	8.00	9.60						
	29.0	61	8.00	9.60						
	30.0	61	8.00	9.60						
	31.0	61	8.00	9.60						
	32.0	61	8.00	9.60						
	33.0	61	8.00	9.60						
	34.0	61	8.00	9.60						
	35.0	61	8.00	9.60						
	36.0	61	8.00	9.60						
	37.0	61	8.00	9.60						
	38.0	61	8.00	9.60						
	39.0	61	8.00	9.60						
	40.0	61	8.00	9.60						
	41.0	61	8.00	9.60						
	42.0	61	8.00	9.60						
	43.0	61	8.00	9.60						
	44.0	61	8.00	9.60						
	45.0	61	8.00	9.60						
	46.0	61	8.00	9.60						
	47.0	61	8.00	9.60						
	48.0	61	8.00	9.60						
	49.0	61	8.00	9.60						
	50.0	61	8.00	9.60						
	51.0	61	8.00	9.60						
	52.0	61	8.00	9.60						
	53.0	61	8.00	9.60						
	54.0	61	8.00	9.60						
	55.0	61	8.00	9.60						
	56.0	61	8.00	9.60						
	57.0	61	8.00	9.60						
	58.0	61	8.00	9.60						
	59.0	61	8.00	9.60						
	60.0	61	8.00	9.60						
	61.0	61	8.00	9.60						
	62.0	61	8.00	9.60						
	63.0	61	8.00	9.60						

Field Sheet B example

Sequence Number
 3 (punch in 3-9 all cards) 3

Study Code 02
 Senior Scientist 47

Category Code 1N
 Submitter Code 60

Number Samples 04
 GIL 37 38

Depth M 0
 Exp GIL 44 45 46 47 48

Flow Value 44 45 46 47 48
 Sensor 0



Maryland Department of Natural Resources
 Field Sheet

Project Name: PXT: Cedar Point
 (XCF9575)
 MANTA Field Office-Howard
 Patuxent River

Submitter: MANTA Field Office-Howard
 Patuxent River

Start Date Year 10 Month 05 Day 18
 Weather Yesterday 30 31
 Tide State 18
 LICOR Number 53 54

Start Time Year 10 Month 05 Day 18
 Cloud Cover (%) 24 25
 Wave Height (M) 27 28
 LICOR Method FD 55 56

End Time Year 10 Month 05 Day 18
 Wind Direction 26 27
 Fyocline Limit 60 61
 Fyocline Limit 62 63

Wind Velocity (Knots) Min. 30 31 Max. 32 33
 Lower (M) 34 35
 Fyocline Limit 36 37

Sign Off Scientist 38 39
 Comments 40 41

Comments 42 43
 Comments 44 45

Comments 46 47
 Comments 48 49

Comments 50 51
 Comments 52 53

Comments 54 55
 Comments 56 57

Comments 58 59
 Comments 60 61

Comments 62 63
 Comments 64 65

Comments 66 67
 Comments 68 69

Comments 70 71
 Comments 72 73

Comments 74 75
 Comments 76 77

Comments 78 79
 Comments 80 81

Comments 82 83
 Comments 84 85

Comments 86 87
 Comments 88 89

Comments 90 91
 Comments 92 93

Comments 94 95
 Comments 96 97

Rep No.	Depth M	Water Temp. C	Field PH	Disolved Oxygen mg/L	Specific Conc. Micros/cm ³	Sainny ppt	Layer Code	LICOR (micromols/m ³) Deck	Underwater	Weather Codes
1	0.1									0
2	0.2									0
3	0.5		0 C		0 0		S			0
4	0.7									0
5	1.0		0 C		0 0					0
6	1.2									0
7	1.5									0
8	1.7									0
9	2.0		0 C		0 0					0
10	2.2									0
11	2.5									0
12	2.5									0
13	2.7									0

Weather Codes:
 10 = none
 11 = drizzle
 12 = rain
 13 = rain, heavy
 14 = squally
 15 = frozen precipitation

Mind Velocity:
 1-3 = slight ripple
 4-6 = small waves, not breaking
 7-10 = scattered whitecaps
 11-16 = numerous whitecaps
 17-21 = moderate waves, many whitecaps
 22-27 = large waves, many whitecaps
 28-33 = sea heaps get off the water. NOW

Wave Height:
 0.40 m = 1-2 ft
 0.60 m = flat calm
 0.95 m = slight ripple
 1.00 m = 2-4 ft
 1.50 m = 4-6 ft

0xford Sample (Jan., April, July, & October)

Date Entered _____

DNR 2/2005

Page 1 of 2

Patuxent River Field Sheet example

DEPARTMENT OF NATURAL RESOURCES
Monitoring and Non-Tidal Assessment
Bay Tributary Filtering Volume Summary
CBL

Sample Filter Volume
Summary Sheet
example

RUN NAME BT4

DATE _____

FIELD SIGNOFF _____

STATION	SAMPLE TIME (mty)	FILTER TIME (mty)	SAMPLE NUMBER	LAYER	DEPTH (M)	SALINITY (ppt)	TSS/PP (ml)	PC/PN (ml)	CHLA (ml)
ET 4.2			21	S	0.5				
			22	AP					
			23	BP					
			24	B					
EE 1.1			25	S	0.5				
			26	AP					
			27	BP					
			28	B					
XGG8251			145	S	0.3				
			R	DUP					

APPENDIX III

MARYLAND DEPARTMENT OF NATURAL RESOURCES CHESAPEAKE BAY WATER QUALITY MONITORING PROGRAM

CROSS REFERENCE SHEET DOCUMENTATION AND PROCEDURES

The following documentation outlines the conventions for filling out the Cross Reference Sheet.

(Note: Although the sheet has a subheading "Progress Report" or "Progress Report / Cross Reference Sheet", it is generally known as the Cross Reference Sheet and should not be confused with the "Cruise Reports/Quarterly Progress Report" described in Appendix IV.)

The Cross Reference Sheet is sent along with Field Sheets from the Field Office to the DNR Tawes Building, so that the DNR data management staff knows what data to expect in the form of field sheets and lab data.

The Cross Reference Sheet includes the name of the program, the sampling month and year, the name of the Field Office representative who originated the sheet. Columns with headings: Station, Day, Depth (m), Sequence #, Sample # list the samples and replicates that were collected. Columns with the headings: Nutrients (CBL), Chloro (CBL), Plankton (Butler) are used to track whether analytical results have been received by DNR data management. The Comments column is used to enter information explaining missing samples, stations, field abnormalities, or potential data problems.

The structures of the Mainstem and Bay Tributaries cross reference sheets are similar.

Examples of Mainstem and Patuxent River cross reference sheets follow: (labeled "Progress Report/Cross Reference Sheet") follow.

Maryland Department of Natural Resources
RAS/MANTA

Chesapeake Bay **Mainstem**
Progress Report / Cross Reference Sheet

Month/ Year: March/2009

Submitted by: laura fabian

Station	Day	Depth (M)	Sequence #	Sample #	Nutrients (CBL)	Chloro. (CBL)	Plankton (Butler)	Comments	
CB5.3 Smith Point	16	27.0	0900301	1			N/S	Sampled aboard RV Rachel Carson.	
		11.0		2			N/S		
		2.0		3			N/S		
		0.5		4			N/S		
LE2.3 Point Lookout	16	20.0	0900302	5			N/S		
		13.0		6			N/S		
		7.0		7			N/S		
		0.5		8			N/S		
CB5.2 Point No Point	16	30.0	0900303	9			N/S		
		19.0		10			N/S		
		9.0		11			N/S		
		0.5/1		12			N/S		
		0.5/2		13			N/S		
CB5.1 Cedar Point	16	34.0	0900304	14					17.0 Meter Plankton for W. Butler.
		23.0		15			N/S		
		11.0		16			N/S		
		0.5		17					

Page 1 of 5

Maryland Department of Natural Resources
MANTA
Chesapeake Bay Water Quality Monitoring
Progress Report – Patuxent River
Month/ Year: March 2010
Submitted by: Debbie Howard

Station	Day	Sample Depth	Sequence Number	Chloro (CBL)	Lab (CBL)	Plankton (W. Butler)	Comments
CB5.1W (Cedar Pt.)	22	0.5	1003P01			n/s	Scattered showers overnight. No Licor-too rough.
		3.0				n/s	
		6.0				n/s	
		9.0				n/s	
LE1.4 (Drum Pt.)	22	0.5	1003P02			n/s	Scattered showers overnight.
		3.0				n/s	
		9.0				n/s	
		16.0				n/s	
LE1.3 (Above Pt. Patience)	22	0.5	1003P03			n/s	Scattered showers overnight.
		3.0				n/s	
		12.0				n/s	
		23.0				n/s	
LE1.2 (St. Leonard)	22	0.5	1003P04			n/s	Scattered showers overnight.
		3.0/ 1				n/s	
		12.0				n/s	
		15.0				n/s	
LE1.1 (Jack Bay)	22	0.5	1003P05		+VSS		MSU sample.
		3.0				n/s	
		9.0				n/s	
		12.0				n/s	

APPENDIX IV

MARYLAND DEPARTMENT OF THE NATURAL RESOURCES CHESAPEAKE BAY WATER QUALITY MONITORING PROGRAM

CRUISE REPORTS/QUARTERLY PROGRESS REPORT DOCUMENTATION AND PROCEDURES

The Cruise Report is filled out by Field Office personnel for each cruise and provided to the Quality Assurance Officer at DNR. Every three months, the Quality Assurance Officer combines and summarizes the Cruise Reports, creating a Quarterly Progress Report to submit to the CBPO.

The Cruise Report includes the cruise identification number, name of the program, the scheduled sampling date, the name of the Field Office representative who submits the sheet, additional sampling activities, the station names, the sampling dates and times, the time that filtering is finished, the time the station is left, the presence or absence of hydrogen sulfide odor and results of any Hach tests conducted, the research vessel name, the names of the captain, crew, and scientific party, the departure time and location, the return time and location, weather conditions, the temperature, the barometric pressure, the estimated wind speed and direction, the equipment conditions, the morning dissolved oxygen check, sample status, and additional comments.

Information Filled out by Field Personnel:

Page 1

1. Cruise I.D. (top left of sheet)

Provide the cruise identification number in the space provided at top left of sheet.

2. Page ___ of ___ (top right of page)

When more than one sheet is generated and sent with samples, enter this information in the area provided, 'Page ___ of ___'. If only one sheet is generated, indicate this by entering page 1 of 1.

3. Day # (top right of page, under page number)

Provide the day number of the cruise (i.e., Day #1, Day #2, or Day #3)

4. Study Location (top of sheet)

If not preprinted, provide the name of the study location (e.g., Mainstem Cruise Report) at the top center of the sheet.

5. Scheduled Sampling Date

Provide the scheduled sampling date in the space provided.

6. Submitted by

Provide the name of the field scientist who originates the sheet.

7. Station Sampled (1st column of sheet)

The station sampled should be preprinted in the first column of the sheet. If not preprinted, enter the station name. (For example, if the samples were collected from station CB5.3, the station sampled would be "CB5.3").

8. Date

Enter the actual date sampled in the space provided.

9. Time

Enter the time the samples are taken.

10. FF (finished filtering)

Enter the time that filtering is finished.

11. LS (left station)

Enter the time of leaving the station.

12. H₂S odor

For both below pycnocline (BP) and bottom (B) layer samples:

- If H₂S odor is present (rotten egg smell), enter "+" and perform a Hach test for hydrogen sulfide. Record the Hach reading.
- If no H₂S odor is present, enter "-".

13. Cruise I.D. (top left of sheet)

Provide the cruise identification number in the space provided at top left of sheet.

Cruise ID numbers consist of last 2 digits of year, 0, and cruise # of year. For example, the cruise ID for the third trip of 2008 would be 08003.

14. Date

Enter the actual sampling date in the space provided.

15. R/V Utilized

Enter the name of the research vessel in the space provided.

16. Captain, Crew and Scientific Party

Enter the names of the Captain, Mate, scientists and occasional collaborators or observers on board. Identify the agency/company that the scientists and observers represent (e.g. DNR, CBL, Baltimore Sun).

17. Departure Time and Location

Enter the departure time and location.

18. Return time and location

Enter the return time and location.

19. Weather conditions

- Enter the air temperature in degrees Celsius for the morning (AM) and afternoon (PM).
- Enter the barometric pressure in inches of mercury for the morning (AM) and afternoon (PM).
- Enter the estimated wind speed in knots and the direction from which the wind is blowing for the morning (AM) and afternoon (PM).

20. Equipment conditions

Enter the refrigerator (FRIDGE) temperature in degrees Celsius. Jan–Jun only (no samples Jul-Dec).

Enter the freezer temperature in degrees Celsius.

21. Morning Dissolved Oxygen (DO) Check

Enter the meter used, meter reading, and whether or not it changed.

Meter readings are logged in Cruise Report when a sonde is changed during a survey.

22. Sample Status

Enter the status of the sample in cases when unusual events might affect a sample. For

example, a refrigerator/freezer failure, or samples transported at odd times.

23. Additional Comments

Enter additional comments as needed.

Pages 3 and 5 are the same as Page 1 (for additional stations).

Pages 4 and 6 are the same as Page 2 (for additional stations).

APPENDIX V

MARYLAND DEPARTMENT OF NATURAL RESOURCES CHESAPEAKE BAY WATER QUALITY MONITORING PROGRAM

FIELD INSTRUMENT QUALITY ASSURANCE/QUALITY CONTROL

These procedures refer to Hydrolab Series 4000, Series 2, Series 3, Series 4a and Series 5 instruments; and to Yellow Springs Instrument (YSI) Series 6 instruments. Detailed calibration procedures are performed as described in their respective operating manuals.

NOTE:

During 2009 Hydrolab Series 5 instruments were converted from Standard Clark Polarographic Dissolved Oxygen Sensors to Optical Dissolved Oxygen Sensors known as Luminescent Dissolved Oxygen (LDO). Temperature, pH, specific conductance and depth sensors will not be changed. All other Hydrolab instruments will continue to have Standard Clark Polarographic Dissolved Oxygen Sensors. Sensor differences in each Series of instrument are noted under Routine Sensor Maintenance (see App V.III.B).

Beginning in February 2009, YSI Series 6 instruments were added to the field instrument inventory. YSI instruments are equipped with an optical dissolved oxygen sensor (ROX) instead of the Standard Clark Polarographic Sensor. Temperature, pH, specific conductance and depth sensors perform similarly to respective Hydrolab sensors.

Both the Hydrolab and YSI optical dissolved oxygen sensors use similar luminescent technology to measure dissolved oxygen.

Mainstem and Patuxent River cruises will exclusively use YSI instead of Hydrolab instruments. All other sampling activities will use Hydrolab or YSI instruments.

I. Calibration

A. Hydrolab Instruments

1. Set up a calibration log book for each instrument with make, model, serial numbers and first-in-service date. Assign a letter for DNR use as required.

2. Calibrate instruments on Friday for use the next week. If possible, calibrate instrument within 24 hours of first field deployment. After one to four days of field deployment, post-calibrate instruments after last use to determine if any parameter has drifted (see App V.III.A.3 and 4 for procedure). If possible, post-calibrate instrument within 24 hours after last field deployment.
3. Calibrate specific conductance with standards generated by the field office from dry KCl and deionized water. Standards are 147, 294, 720, 1413, 2767, 6668, 12900, 24820 and 58640 microSiemens/cm ($\mu\text{S}/\text{cm}$) (microSiemens/cm is equivalent to micromhos/cm at 25°C). Respective concentrations are 0.001, 0.002, 0.005, 0.01, 0.02, 0.05, 0.1, 0.2 and 0.5 molar KCl. Calibrate specific conductance of Series 4000, Series 2 and Series 3 instruments following a two point linear protocol with one of the above standards as the slope standard. The zero point is factory calibrated and cannot be adjusted by the user. Calibrate specific conductance of Series 4a and 5 instruments following a two point linear protocol. Calibrate the zero point with the probe dry and the slope with one of the above standards.
4. Calibrate pH with premixed standards of pH 4.00, pH 7.00 and pH 10.00 purchased from Fisher Scientific. Standards are color coded (red for pH 4.00, yellow for pH 7.00 and blue for pH 10.00), certified as accurate at 25°C (pH 4.00 \pm 0.01, pH 7.00 \pm 0.01, pH 10.00 \pm 0.02) and used before their labeled expiration dates. Calibrate pH with these standards using a two point linear protocol. First, calibrate the zero point with pH 7.00 standard buffer. Then, calibrate slope with either pH 4.00 or 10.00 standard buffer. The slope buffer is selected so that pH measurements anticipated during field deployment are between the zero point and slope buffer values.
5. Dissolved Oxygen (DO)

Calibrate the Standard Clark Polarographic Probe using a 1 point mg/L saturation protocol in the common standard of water-saturated air. Determine the oxygen saturation calibration point in water-saturated air from theoretical DO saturation tables using the temperature from the instrument and local barometric pressure from a standard Fortner Mercury Barometer. The DO membrane is visually inspected before an instrument is calibrated. If the membrane is damaged, the membrane and electrolyte are replaced and the DO probe is calibrated 24 hours later. Instruments used for Mainstem Cruises receive a morning-of-use DO check (App V.II.B.). A specific notation on the field data sheet shows which Hydrolab instruments are equipped with this probe.

Calibrate the optical dissolved oxygen probe (Luminescent Dissolved Oxygen – LDO) using a 1 point percent saturation protocol in the common standard of air saturated water. The volume of water must have a specific conductance less than

500 $\mu\text{S}/\text{cm}$. Determine the oxygen saturation calibration point in air-saturated water from theoretical DO saturation tables using the temperature from the instrument and local barometric pressure from a standard Fortner Mercury Barometer. A specific notation on the field data sheet shows which Hydrolab instruments are equipped with this probe.

6. Temperature is calibrated by the manufacturer and cannot be adjusted by the user.
7. Calibrate depth with the probes submerged to a known depth at the field sampling station.
8. Record all calibration and post-calibration information (e.g. barometric pressure, calibration values and instrument readings), maintenance procedures and repairs in the instrument specific calibration log book. An example of this log is included.
9. During calibration, post-calibration and field deployment, record in the calibration log book any unusual circumstances that may affect instrument readings.

B. YSI Instruments

1. Set up a calibration log book for each instrument with make, model, serial numbers and first-in-service date. Assign a letter for DNR use as required.
2. Calibrate instruments on Friday for use the next week. If possible, calibrate instrument within 24 hours of first field deployment. After one to four days of field deployment, post-calibrate instruments after last use to determine if any parameter has drifted (see App V.III.A.3 and 4 for procedure). If possible, post-calibrate instrument within 24 hours after last field deployment.
3. Calibrate specific conductance with standards generated by the field office from dry KCl and deionized water. Standards are 147, 294, 720, 1413, 2767, 6668, 12900, 24820 and 58640 microSiemens/cm ($\mu\text{S}/\text{cm}$) (microSiemens/cm is equivalent to micromhos/cm at 25°C). Respective concentrations are 0.001, 0.002, 0.005, 0.01, 0.02, 0.05, 0.1, 0.2 and 0.5 molar KCl. Calibrate specific conductance following a two point linear protocol with one of the above standards as the slope standard. The zero point is factory calibrated and cannot be adjusted by the user.
4. Calibrate pH with premixed standards of pH 4.00, pH 7.00 and pH 10.00 purchased from Fisher Scientific. Standards are color coded (red for pH 4.00, yellow for pH 7.00 and blue for pH 10.00), certified as accurate at 25°C (pH 4.00 \pm 0.01, pH 7.00 \pm 0.01, pH 10.00 \pm 0.02) and used before their labeled expiration dates. Calibrate pH with these standards using a two point linear protocol. First, calibrate the zero point with pH 7.00 standard buffer. Then, calibrate slope with either pH 4.00 or

10.00 standard buffer. The slope buffer is selected so that pH measurements anticipated during field deployment are between the zero point and slope buffer values.

5. Calibrate optical dissolved oxygen probe (ROX) using a 1 point percent saturation protocol in the common standard of air saturated water. The volume of water must have a specific conductance less than 500 $\mu\text{S}/\text{cm}$. Determine the oxygen saturation calibration point in air-saturated water from theoretical DO saturation tables using the temperature from the instrument and local barometric pressure from a standard Fortner Mercury Barometer. A specific notation on the field data sheet shows that these instruments are equipped with a ROX probe. Check and calibrate, if necessary, the instrument barometer against a standard Fortner Mercury Barometer. A specific notation on the field data sheet shows that these instruments are equipped with a ROX probe.
6. Temperature is calibrated by the manufacturer and cannot be adjusted by the user.
7. Calibrate depth with the probes submerged to a known depth at the field sampling station.
8. Record all calibration and post-calibration information (e.g. barometric pressure, calibration values and instrument readings), maintenance procedures and repairs in the instrument specific calibration log book. An example of this log is included.
9. During calibration, post-calibration and field deployment, record in the calibration log book any unusual circumstances which may affect the instrument readings.

II Field Deployment and Verification of Instrument Performance

- A. Teams carry two calibrated instruments in case of failure. Readings from the instrument in use are compared to those from the second instrument only when the field scientist recording measurements observes readings (a) that are outside reasonably expected values, (b) that are variable or erratic, or (c) if the instrument displays an error message. If these instruments do not agree within QA/QC guidelines and the field scientist reasonably believes that the primary instrument is not working correctly, the second instrument is used. This is noted on the field sheet, cruise report, and instrument calibration log. The instrument supervisor is also informed. If instrument post-calibration readings are outside quality guidelines, DNR will flag the data using the CBP problem code: "V" – "sample results rejected due to quality control criteria".
- B. Each day of a Mainstem Cruise both instruments receive a dissolved oxygen validation check. Set up the instruments for a dissolved oxygen calibration as appropriate for the

type of probe. Follow procedures for the dissolved oxygen validation check to adjust the calibration only if the reading is greater than ± 0.20 mg/L from the saturation calibration point. If the reading is greater than ± 0.50 mg/L, the instrument is not used for field measurements until evaluated by the instrument supervisor.

III. Maintenance

A. Post Field Deployment Maintenance

1. Daily: At the end of each day of use, rinse probes with de-ionized or tap water and install the storage cup filled with sufficient tap water so the pH and reference probes are not submerged.
2. Weekly: At the end of each week, rinse entire instrument (sonde, cable and display) and basket carrier with tap water. Rinse probes with de-ionized or tap water and install the storage cup filled with sufficient tap water so the pH and reference probes are not submerged.
3. Post-calibrate dissolved oxygen, pH and specific conductance for each instrument weekly on Friday after one to four days of field sampling. If possible, post-calibrate instrument within 24 hours after last use. Post-calibrate instrument only after probes stabilize to room temperature (20-25°C). Post-calibrate instruments using the same standards and procedures as were used during calibration except the calibration settings are not adjusted. For instruments with a Standard Clark Polarographic DO sensor, visually inspect the membrane, gold cathode and silver anode before post-calibration. For instruments with an optical DO sensor, visually inspect the luminescent material before post-calibration. If either DO sensor is damaged, describe the damage in the calibration log and post-calibrate the sensor as is. Damage to either type of DO probe is repaired before next calibration and field deployment. If during field deployment, instrument readings of pH and specific conductance fall outside the range of the zero and slope calibration standards, make additional post-calibration readings of appropriate pH and specific conductance standards. All post-calibration standards and instrument readings are recorded in the calibration log.
4. If readings of a parameter during post-calibration are outside quality guidelines, note this in the calibration log and inform the field quality assurance officer. The QA officer will determine if the instrument is operating correctly and if associated field data are reliable.

Instrument parameter readings that are outside quality guidelines during post-calibration are flagged on field data sheets with the Analytical Problem Code (APC) value 'F'. The description of APC 'F' is: "Field data instrument post calibration failed"

but data within theoretical limits, (e.g. post cal failed but data kept)” see Appendix XI.

All field data, including instrument data, are re-evaluated during quality assurance, (see step 3 of DATA MANAGEMENT, VERIFICATION AND DOCUMENTATION). If the analyst/biologist and Quality Assurance Officer determine that the data are not usable, values are flagged with the APC code ‘V’. The definition for APC code ‘V’ is: “Sample results rejected due to quality control criteria”, see Appendix XI.

B. Routine Sensor Maintenance and Performance Verification: sensor and overall instrument maintenance is conducted at approximately ten week intervals.

1. Hydrolab Instruments

a. Dissolved Oxygen Sensor

- (1). Standard Clark Polarographic Sensor: All series of Hydrolab instruments use the same Standard Clark Polarographic Sensor. Remove old membrane and electrolyte, polish gold cathode, inspect silver anode, fill sensor with fresh electrolyte and install new DO membrane.
- (2). Luminescent Dissolved Oxygen Sensor (LDO) (optical sensor): Only Series 5 instruments have this sensor. Remove plastic cap on end of sensor. Inspect cap for integrity of luminescent material, optical path for water, area under optical glass for condensation, and integrity of o-ring seals. Water or condensation interferes with optical path. If plastic cap will be reused, replace o-rings as needed and reinstall on sensor. Gently clean plastic cap exterior surface with cotton swab soaked in laboratory soap and rinse with deionized water. Replace plastic cap once per year or sooner, if damaged. Organic solvents, such as, methanol and acetone, should never contact any part of this sensor.

b. Specific Conductance Sensor

- (1). Series 4000, 2 and 3 (six nickel electrode array): Remove cell block, clean with laboratory soap and rinse with de-ionized water. Polish all surfaces of the six electrodes with 400 grit wet/dry sandpaper. Wipe electrodes with cotton swab soaked with 100% methanol and then fresh cotton swab soaked with 100% acetone, rinsing with de-ionized water after each wiping. Reinstall cell block.
- (2). Series 4a and 5 (graphite sensor): Wipe all surfaces of probe with cotton

swab soaked with laboratory soap and then fresh cotton swab soaked with 100% methanol, rinsing with de-ionized water after each wiping.

- c. pH System: each series of instruments uses a paired sensor system (*in situ* and reference sensors)
 - (1). Series 4000 and 2: *in situ* and reference sensors are bulb type Ag/AgCl glass sensors. Reference sensor is inside a sleeve capped with a porous Teflon™ junction and filled with electrolyte (aqueous pH 7 buffer saturated with KCl). Remove junction sleeve from reference sensor and rinse sensor with de-ionized water. Wipe both glass sensors with cotton swab soaked in 100% methanol and 100% acetone, rinsing with de-ionized water after each wiping. Soak sensors in 0.1 N HCl for no more than 30 minutes. Rinse with de-ionized water after soaking. Install new junction on sleeve, fill sleeve with fresh electrolyte and reinstall sleeve on reference sensor.
 - (2). Series 3, 4a and 5: *in situ* sensor is bulb type Ag/AgCl glass sensor. Reference sensor is a pellet of silver inside a sleeve capped with a porous Teflon™ junction and filled with electrolyte (4M KCl aqueous solution saturated with AgCl₂). Clean *in situ* glass sensor as above. Remove junction sleeve from reference sensor. Do not clean pellet of silver. Install new junction on sleeve, fill sleeve with fresh electrolyte, add one KCl pellet in sleeve, and reinstall sleeve on reference sensor.
- d. Depth Sensor
 - (1). Series 4000: Does not have a depth sensor.
 - (2). Series 2 (differential strain gauge transducer): Inspect sensor port and remove any obstructions. Soak sensor in "Lime-Off" (Jungle Products) for no more than 30 minutes. Rinse sensor thoroughly with deionized water.
 - (3). Series 3, 4a and 5 (stainless steel differential strain gauge transducer): Inspect sensor port and remove any obstructions. No further maintenance is required.
- e. Temperature Sensor (all Series of Hydrolab instruments use similar temperature stainless steel thermistors): Wipe with cotton swab soaked in 100% methanol and 100% acetone, rinsing with de-ionized water after each wiping.

2. YSI Instruments (Series 6)

- a. Dissolved Oxygen Sensor: Reliable Oxygen Sensor (ROX) (luminescent optical

- sensor). Remove membrane assembly on end of sensor. Inspect membrane for integrity of luminescent material, optical path for water, area under optical glass for condensation, and integrity of assembly o-ring seals. Water or condensation interferes with optical path. If membrane assembly will be reused, replace o-rings as needed and reinstall on sensor. Gently clean membrane exterior surface with cotton swab soaked in laboratory soap and rinse with deionized water. Replace membrane assembly once per year or sooner, if damaged. Organic solvents, such as, methanol and acetone, should never contact any part of this sensor.
- b. Specific Conductance Sensor (four nickel electrode array): Soak small nylon bristle brush in laboratory soap and gently push back and forth through channel. Rinse with deionized water.
 - c. pH System: Model 6561 System is a glass bulb type combination electrode consisting of a proton selective glass bulb reservoir filled with buffer at approximately pH 7 and a Ag/AgCl reference electrode. Soak cotton swab in laboratory soap and gently wipe glass bulb. Rinse with deionized water. If required, soak glass bulb sensor in 1 M HCl for 30 – 60 minutes. Rinse with deionized water.
 - d. Depth Sensor (differential strain gauge transducer): Insure that access ports are clear of debris. Using a plastic syringe flush clean tap or deionized water through one port and out the other.
 - e. Temperature Sensor (stainless steel thermistor): Soak cotton swab in laboratory soap and gently clean surface of sensor. Rinse with deionized water.
3. Sensor Performance Verification: After routine sensor maintenance, the performance of Hydrolab and YSI instruments are verified as follows before assignment to field surveys. Instruments that do not satisfy these criteria are repaired in house or returned to the manufacturer for repair. Performance verification is documented in the calibration log for each instrument.
- a. Temperature: Submerge sensor and traceable standard mercury thermometer in freshwater at room temperature (20° - 25°C). Instrument reading must be stable and within 0.20°C of the standard thermometer.
 - b. Dissolved Oxygen: Calibrate Standard Clark Polarographic Sensors and Optical Sensors are in the standard of water saturated air and air saturated water, respectively. Sensors must calibrate to this saturation standard value and remain stable within 0.05 mg/L of standard over a two minute interval.
 - c. pH: Calibrate system using the two point linear protocol (zero point and slope).

Calibrate zero point with pH 7 standard buffer. Check slope with pH 10 standard buffer but do not calibrate. Check response of system to pH 4 standard buffer but do not calibrate. Instrument should read stable pH values within 2 minutes of immersion in standard buffer whether calibrated or not. Instrument readings of pH 10 and 4 standard buffers should be within 0.20 units of standard value.

d. Specific Conductance

For all series of Hydrolab instruments calibrate in any of three autoranges (0 – 1500 $\mu\text{S}/\text{cm}$, 1500 – 15,000 $\mu\text{S}/\text{cm}$, and 15,000 – 150,000 $\mu\text{S}/\text{cm}$) using a two point linear protocol as described in Calibration Section (App V.I.A.3). Select a standard in an adjacent autorange and check linearity response. Instrument reading should be within $\pm 5\%$ of standard.

For YSI Series 6 instruments calibrate with a standard from one of the three Hydrolab autoranges above using a two point linear protocol as described in Calibration Section (App V.I.B.3). Select a standard in an adjacent Hydrolab autorange and check linearity response. Instrument reading should be within $\pm 5\%$ of standard.

e. Depth: Calibrate zero point in air. Sensor should calibrate and read stable value.

IV. Secchi disk: Each year the secchi disk line is calibrated by comparing its 0.2m marks to a metal meter stick. Each mark is a small piece of colored flat synthetic webbing pulled through the line and sewn for security. Marks are moved if the webbing does not line up with the corresponding line on the meter stick.

V. Annual audits of all field equipment log books, maintenance records and field procedures will be conducted by the field quality assurance officer provided there is time available. This information will be reported to the DNR Quality Assurance Officer. (See Quality Assurance Project Plan, Section 8: Project Organization and Responsibility).

APPENDIX VI

MARYLAND DEPARTMENT OF NATURAL RESOURCES CHESAPEAKE BAY WATER QUALITY MONITORING PROGRAM

FIELD PROCEDURES QUALITY ASSURANCE / QUALITY CONTROL

I. Cleaning procedures:

- A. Autoanalyzer cups and caps: Cups and caps are used only one time and then discarded.
- B. DOC tubes: Place tubes in 10 % HCl bath for approximately 24 hours; follow by rinsing tubes several times in deionized water.
- C. DOC caps: Place tubes in 10 % HCl bath for approximately 24 hours; follow by rinsing tubes several times in deionized water.
- D. TDN/TDP tubes: New tubes are digested using potassium persulfate followed by multiple deionized water rinses. Tubes that are "in-the-cycle" are cleaned by emptying old contents, rinsing the tubes and caps with 3-4 tap water rinses followed by 6 rinses with deionized water.

II. Review of procedures for field and lab sheets in the field

A. "Scientist signoff" duties

The field scientist is responsible for recording values on the field data sheets and on the lab sheets. This includes entering all Hydrolab values, calculating the pycnocline, and ensuring that the field data sheet is complete. This individual is also responsible for transcribing necessary header information onto the lab sheets.

B. "Senior scientist" duties

The individual who enters their initials in the 'senior scientist' boxes is the scientist who is officially designated as being in charge of the cruise.

Mainstem Cruises:

1. The senior scientist as field quality assurance officer on cruise should ensure that:
 - a. Thermometers are placed in refrigerator and freezer to monitor daily temperatures (4

°C for refrigerator and -10 to -20 °C for freezer) and record data on cruise report. If temperatures are too high, they should be set lower if possible and if not possible, notify the Captain of the research vessel.

b. Check with Captain of the research vessel to ensure that weather and location instruments used onboard the ship (e.g., Raytheon factory calibrated barometer, anemometer, or GPS) are functioning properly and, if not, record it in the Cruise Report.

c. Check to make sure all equipment necessary to accomplish sampling is on board and functioning before leaving dock.

d. Document and report back to the field quality assurance officer any deviations from existing protocol or problems that have arisen during the cruise.

III. Dissolved Oxygen Calibrations and Checks

Dissolved Oxygen calibration shall be done every morning for mainstem sampling. Instruments with a standard Clark cell are calibrated on the common standard of water-saturated air. Instruments with optical probes are calibrated on the standard of air-saturated water. After correcting for the barometric pressure and temperature the oxygen content can be checked against standard D.O. tables. The DO membrane (Clark cell) is also visually checked every time the meter is calibrated or post-calibrated. If the membrane appears damaged, the meter is posted as is. Then the membrane and electrolyte are replaced and the meter is calibrated after 24 hours.

IV. Spare Hydrolab/ YSI Meter

As discussed in Appendix 5 (Field Instrument Quality Assurance/Quality Control), teams carry two calibrated Hydrolab/ YSI meters in case of failure. The meter in use is compared to the reserve meter any time (a) the field scientist recording measurements observes values outside the "typically expected range"; (b) the meter generates variable or erratic values; or, (c) the meter in use displays an error message. If the meters do not agree within acceptable limits, the reserve meter is used. This is noted under the additional comments section.

V. Deionized water

The deionized water at the Field Office is generated from tap water using a Thermo Scientific Barnstead DIAMOND TII RO/DI system with a GE SmartWater external pre-filter. The RO/ DI system is linked to a Thermo Scientific Barnstead DIAMOND TII 60L storage reservoir. The system uses a thin film composite reverse osmosis membrane with pretreatment to produce RO water. This water is then put through a two-stage deionization process combined with

UV oxidation and a 0.2 micron final filter. The reagent grade water provided by this system exceeds ASTM Type II and NCCLS/CAP Type I standards. All manufacturer recommendations are followed regarding cartridge replacement and system sanitation (Refer to Thermo Scientific, 2007, Barnstead DIamond TII Type II Water System Operation Manual and Barnstead DIamond TII Type II Storage Reservoir Operation Manual). The GE SmartWater pre-filter was placed inline to improve the integrity of feed-water going into the Barnstead DIamond System. The pre-filter is changed at least every three (3) months or more frequently during periods of heavy use. A log is kept at the front of the DI System Manual to document all changes and updates made to the system. Also, starting in 2010, along with filtered samples for nutrient analysis, blank DI samples will be sent to CBL to check for contamination of DI water used in filtering samples.

VI. Transfer of nutrient samples/sheets to laboratory

All samples are delivered to CBL at the end of the sampling week. The samples are placed in the freezer at the Field Office until delivery. The silicate samples that are collected at a subset of stations are stored in the Field Office refrigerator. The samples are packed with dewatered ice in a cooler. Do not place the silicates directly in the ice as this may cause them to freeze. The volume sheets for each sampling run are placed in a bin marked "CBL" on the side of the Field Office freezer at the end of the field day. The laboratory (volume) sheets must be collected from the bin and accompany all samples to CBL.

Determination of Dissolved Inorganic Nitrate plus Nitrite (NO₃+NO₂) in Fresh/Estuarine/Coastal Waters Using Cadmium Reduction

1. SCOPE and APPLICATION

- 1.1 Cadmium reduction is used to quantitatively reduce dissolved nitrate to nitrite which is then measured by colorimetric quantitative analysis of a highly colored azo dye. The method is used to analyze all ranges of salinity.
- 1.2 A Method Detection Limit (MDL) of 0.0007 mg NO₃+NO₂-N/L was determined using 3X the standard deviation of 7 replicates.
- 1.3 The Quantitation Limit for NO₃+NO₂ was set at 0.0035 mg NO₃+NO₂-N/L.
- 1.4 The method is suitable NO₃+NO₂ concentrations 0.0007 to .056 mg NO₃+NO₂-N/L.
- 1.5 This procedure should be used by analysts experienced in the theory and application of aqueous inorganic analysis. Three months experience with an experienced analyst, certified in the analysis of nitrate plus nitrite in aqueous samples by cadmium reduction is required.
- 1.6 This method can be used for all programs that require analysis of dissolved inorganic nitrate plus nitrite.
- 1.7 This procedure conforms to EPA Method 353.2 (1979).

2. SUMMARY

2.1 Filtered samples are passed through a granulated copper-cadmium column to reduce nitrate to nitrite. The nitrite, both that which was reduced from nitrate and nitrite that was originally present, is then determined by diazotizing with sulfanilamide and coupling with N-1-naphthylethylenediamine dihydrochloride to form a colored azo dye.

3. DEFINITIONS

- 3.1 Acceptance Criteria – Specified limits placed on characteristics of an item, process, or service defined in a requirement document. (ASQC)
- 3.2 Accuracy – The degree of agreement between an observed value and an accepted reference value. Accuracy includes a combination of random error (precision) and systematic error (bias) components which are due to sampling and analytical operations; a data quality indicator. (QAMS)
- 3.3 Aliquot – A discrete, measured, representative portion of a sample taken for analysis. (EPA QAD Glossary)
- 3.4 Analytical Range – 0.0007 to 0.056 mg NO₃+NO₂-N/L, using black/black sample pump tube and yellow/yellow ammonium chloride diluent pump tube at a Standard Calibration setting of 9.00.

- 3.5 Batch – Environmental samples, which are prepared and /or analyzed together with the same process and personnel, using the same lot(s) of reagents. A **preparation batch** is composed of one to 300 environmental samples of the same matrix, meeting the above mentioned criteria and with a maximum time between the start of processing of the first and last sample in the batch to be 10 hours. An **analytical batch** is composed of prepared environmental samples (extracts, digestates, or concentrates) and/or those samples not requiring preparation, which are analyzed together as a group using the same calibration curve or factor. An analytical batch can include samples originating from various environmental matrices and can exceed 20 samples. (NELAC/EPA)
- 3.6 Blank- A sample that has not been exposed to the analyzed sample stream in order to monitor contamination during sampling, transport, storage or analysis. The blank is subjected to the usual analytical and measurement process to establish a zero baseline or background value and is sometimes used to adjust or correct routine analytical results. (ASQC)
- 3.7 Calibrate- To determine, by measurement or comparison with a standard, the correct value of each scale reading on a meter or other device, or the correct value for each setting of a control knob. The levels of the applied calibration standard should bracket the range of planned or expected sample measurements. (NELAC)
- 3.8 Calibration – The set of operations which establish, under specified conditions, the relationship between values indicated by a measuring device. The levels of the applied calibration standard should bracket the range of planned or expected sample measurements. (NELAC)
- 3.9 Calibration Blank – A volume of reagent water fortified with the same matrix as the calibration standards, without analyte added.
- 3.10 Calibration Curve – The graphical relationship between known values, such as concentrations, or a series of calibration standards and their analytical response. (NELAC)
- 3.11 Calibration Method – A defined technical procedure for performing a calibration. (NELAC)
- 3.12 Calibration Standard – A substance or reference material used to calibrate an instrument. (QAMS)
- 3.12.1 Initial Calibration Standard (STD) – A series of standard solutions used to initially establish instrument calibration responses and develop calibration curves for individual target analytes.
- 3.12.2 Initial Calibration Verification (ICV) – An individual standard, distinct from the Initial Calibration Standards (STD), analyzed initially, prior to any sample analysis, which verifies acceptability of the calibration curve or previously established calibration curve.

- 3.12.3 Continuing Calibration Verification (CCV) – An individual standard which is analyzed after every 15-20 field sample analysis.
- 3.13 Certified Reference Material – A reference material one or more of whose property values are certified by a technically valid procedure, accompanied by or traceable to a certificate or other documentation which is issued by a certifying body. (ISO 17025)
- 3.14 Colorimeter – Detector found in Bran & Luebbe Single-Channel Industrial Colorimeter. Color is quantitatively detected with 199-B021-01 phototubes using 550 nm monochromatic filters and 50 mm long flow cell with 1.5 mm internal diameter. Comparisons are made between signals from the colored solution in the flow cell to the signal of air in the reference cell. Signals from the Colorimeter are transmitted to a Recorder.
- 3.15 Corrective Action – Action taken to eliminate the causes of an existing nonconformity, defect or other undesirable situation in order to prevent recurrence. (ISO 8402)
- 3.16 Deficiency – An unauthorized deviation from acceptable procedures or practices. (ASQC)
- 3.17 Demonstration of Capability – A procedure to establish the ability of the analyst to generate acceptable accuracy. (NELAC)
- 3.18 Detection Limit – The lowest concentration or amount of the target analyte that can be determined to be different from zero by a single measurement at a stated degree of confidence.
- 3.19 Duplicate Analysis – The analyses of measurements of the variable of interest performed identically on two sub samples (aliquots) of the same sample. The results from duplicate analyses are used to evaluate analytical or measurement precision but not the precision of sampling, preservation or storage internal to the laboratory. (EPA-QAD)
- 3.20 External Standard (ES) – A pure analyte (potassium nitrate (KN O₃)) that is measured in an experiment separate from the experiment used to measure the analyte(s) in the sample. The signal observed for a known quantity of the pure external standard is used to calibrate the instrument response for the corresponding analyte(s). The instrument response is used to calculate the concentrations of the analyte(s) in the unknown sample.
- 3.21 Field Duplicates (FD1 and FD2) – Two separate samples collected at the same time and place under identical circumstances and treated exactly the same throughout field and laboratory procedures. Analyses of FD1 and FD2 provide a measure of the precision associated with sample collection, preservation and storage, as well as with laboratory procedures.
- 3.22 Field Reagent Blank (FRB) – A aliquot of reagent water or other blank matrix that is placed in a sample container in the laboratory and treated as a sample in all respects, including shipment to the sampling site, exposure to the sampling site conditions, storage, preservation,

and all analytical procedures. The purpose of the FRB is to determine if method analytes or other interferences are present in the field environment.

- 3.23 Holding time – The maximum time that samples may be held prior to analysis and still be considered valid. (40 CFR Part 136) The time elapsed from the time of sampling to the time of extraction or analysis, as appropriate.
- 3.24 Instrument Detection Limit (IDL) – The minimum quantity of analyte of the concentration equivalent which gives an analyte signal equal to three times the standard deviation of the background signal at the selected wavelength, mass, retention time absorbance line, etc.
- 3.25 Laboratory Duplicates (LD1 and LD2) – Two aliquots of the same sample taken in the laboratory and analyzed separately with identical procedures. Analyses of LD1 and LD2 indicate precision associated with laboratory procedures, but not with sample collection, preservation, or storage procedures.
- 3.26 Laboratory Reagent Blank (LRB) – A blank matrix (i.e., DI water) that is treated exactly as a sample including exposure to all glassware, equipment, solvents, and reagents that are used with other samples. The LRB is used to determine if method analytes or other interferences are present in the laboratory environment, the reagents, or the instrument.
- 3.27 Laboratory Control Sample (LCS) – A sample matrix, free from the analytes of interest, spiked with verified known amounts of analytes from a source independent of the calibration standard or a material containing known and verified amounts of analytes. The LCS is generally used to establish intra-laboratory or analyst-specific precision and bias or to assess the performance of all or a portion of the measurement system. (NELAC)
- 3.28 Limit of Detection (LOD) – The lowest concentration level that can be determined by a single analysis and with a defined level of confidence to be statistically different from a blank. (ACS)
- 3.29 Limit of Quantitation (LOQ) – The minimum levels, concentrations, or quantities of a target variable (target analyte) that can be reported with a specified degree of confidence. The LOQ is set at 3 to 10 times the LOD, depending on the degree of confidence desired.
- 3.30 Linear Dynamic Range (LDR) – The absolute quantity over which the instrument response to an analyte is linear. This specification is also referred to as the Linear Calibration Range (LCR).
- 3.31 Manifold – The module whose configuration of glass connectors, fittings, mixing coils, tubing and Cadmium-Copper reduction column precisely reduces the nitrate in the sample to nitrite, followed by color production.
- 3.32 Material Safety Data Sheets (MSDS) – Written information provided by vendors concerning a chemical's toxicity, health hazards,

physical properties, fire, and reactivity data including storage, spill, and handling precautions.

- 3.33 May – Denotes permitted action, but not required action. (NELAC)
- 3.34 Method Detection Limit (MDL) – The minimum concentration of an analyte that can be identified, measured, and reported with 99% confidence that the analyte concentration is greater than zero. (Standard Methods)
- 3.35 Must – Denotes a requirement that must be met. (Random House College Dictionary)
- 3.36 Precision – The degree to which a set of observations or measurements of the same property, obtained under similar conditions, conform to themselves; a data quality indicator. Precision is usually expressed as standard deviation, variance or range, in either absolute or relative terms. (NELAC)
- 3.37 Preservation – Refrigeration, freezing, and/or reagents added at the time of sample collection (or later) to maintain the chemical and or biological integrity of the sample.
- 3.38 Proportioning Pump – A peristaltic pump that mixes and advances samples and reagents through proscribed precision pump tubes proportionately for the reactions to take place and for the concentration to be measured.
- 3.39 Quality Control Sample (QCS) – A sample of analyte of known and certified concentration. The QCS is obtained from a source external to the laboratory and different from the source of calibration standards. It is used to check laboratory performance with externally prepared test materials.
- 3.40 Recorder – A graphic recorder used to record electronic output from the colorimeter.
- 3.41 Run Cycle – Typically a day of operation – the entire analytical sequence from sampling the first standard to the last sample of the day.
- 3.42 Sampler – An automated rotational device that moves sample cups sequentially to aspirate an aliquot into the proscribed analytical stream. As the loaded sample tray rotates, a metal probe dips into the sample cup and aspirates sample for a preset time, rises from the sample cup and aspirates air for approximately one second and goes into a deionized water-filled wash receptacle, where deionized water is aspirated. After another preset interval, the probe rises from the wash receptacle, aspirates air and moves into the next sample cup. The sampler moves at a rate of 40 samples per hour with a sample to wash solution ratio of 9:1.
- 3.43 Sensitivity – The capability of a test method or instrument to discriminate between measurement responses representing different levels (concentrations) of a variable of interest.

- 3.44 Shall – Denotes a requirement that is mandatory whenever the criterion for conformance with the specification requires that there be no deviation. (ANSI)
- 3.45 Should – Denotes a guideline or recommendation whenever noncompliance with the specification is permissible. (ANSI)
- 3.46 Standard Reference Material (SRM) – Material which has been certified for specific analytes by a variety of analytical techniques and/or by numerous laboratories using similar analytical techniques. These may consist of pure chemicals, buffers, or compositional standards. The materials are used as an indication of the accuracy of a specific analytical technique.

4 INTERFERENCES

- 4.1 Suspended matter in the sample will restrict flow through the apparatus. All samples must be filtered. See Section XXX.
- 4.2 Concentrations of sulfide, iron, copper or other metals above several milligrams per liter lower reduction efficiency, yielding inaccurate concentrations for those samples and, also, subsequent analyses. Frequent checks of column efficiency and re-analyses of affected samples are necessary.

5 SAFETY

- 5.1 Safety precautions must be taken when handling reagents, samples and equipment in the laboratory. Protective clothing including lab coats, safety glasses and enclosed shoes should be worn. In certain situations, it will be necessary to also use gloves and/or a face shield. If solutions come in contact with eyes, flush with water continuously for 15 minutes. If solutions come in contact with skin, wash thoroughly with soap and water. Contact Solomons Rescue Squad (911) if emergency treatment is needed and also inform the CBL Business Manager of the incident. Contact the CBL Business Manager if additional treatment is required.
- 5.2 The toxicity or carcinogenicity of each reagent used in this procedure may not have been fully established. Each chemical should be regarded as a potential health hazard and exposure should be as low as reasonably achievable. Cautions are included for known hazardous materials and procedures.
- 5.3 Do not wear jewelry when troubleshooting electrical components. Even low voltage points are dangerous and can injure if allowed to short circuit.
- 5.4 The following hazard classifications are listed for the chemicals used in this procedure. Detailed information is provided on Material Safety Data Sheets (MSDS).

Chemical	Health	Flammability	Reactivity	Contact	Storage
Sodium Hydroxide	3	0	2	4	White Stripe
Copper Sulfate	2	0	0	2	Green
Ammonium Chloride	2	0	2	2	Green
Sulfanilamide	0	1	1	1	Green
N-1-naphthylethylenediamine dihydrochloride	2	1	1	2	Green
Brij-35	1	0	0	1	Green
Phosphoric Acid	3	0	2	4	White
Hydrochloric Acid	3	0	2	4	White
Acetone	1	4	2	1	Red
Cadmium	3	2	1	4	Red
Potassium nitrate	2	0	3	2	Yellow
Sodium nitrite	2	0	3	2	Yellow
Chloroform	3	1	1	3	Blue

On a scale of 0 to 4, the substance is rated on four hazard categories: health, flammability, reactivity, and contact. (0 is non-hazardous and 4 is extremely hazardous)
STORAGE

Red – Flammability Hazard: Store in a flammable liquid storage area.

Blue – Health Hazard: Store in a secure poison area.

Yellow – Reactivity Hazard: Keep separate from flammable and combustible materials.

White – Contact Hazard: Store in a corrosion-proof area.

Green – Use general chemical storage (On older labels, this category was orange).

Striped – Incompatible materials of the same color class have striped labels. These products should not be stored adjacent to substances with the same color label. Proper storage must be individually determined.

6 EQUIPMENT AND SUPPLIES

6.1 Technicon Bran & Luebbe AutoAnalyzer II sampler, proportioning pump, manifold and colorimeter capable of analyzing for nitrate plus nitrite nitrogen are used in this laboratory. A PMC Industries Flat Bed Linear recorder is used to record electronic output from the colorimeter.

6.2 Freezer, capable of maintaining $-20 \pm 5^{\circ} \text{C}$.

6.3 Lab ware – All reusable lab ware (glass, Teflon, plastic, etc) should be sufficiently clean for the task objectives. This laboratory cleans all lab ware related to this method with a 10% HCl (v/v) acid rinse.

7 REAGENTS AND STANDARDS

7.1 Purity of Water – Unless otherwise indicated, references to water shall be understood to mean reagent water conforming to Specification D 1193, Type I. Freshly prepared water should be used for making the standards

intended for calibration. The detection limits of this method will be limited by the purity of the water and reagents used to make the standards.

7.2 Purity of Reagents – Reagent grade chemicals shall be used in all tests.

Unless otherwise indicated, it is intended that all reagents shall conform to specifications of the Committee on Analytical Reagents of the American Chemical Society, where such specifications are available. Other grades may be used, provided it is first ascertained that the reagent is of sufficiently high purity to permit its use without compromising the accuracy of the determination.

7.3 Alkaline Water –

Sodium hydroxide (NaOH, pellets)	0.20±0.02 g
Deionized water	up to 1000 mL

Add 0.20 g of sodium hydroxide pellets to 1000 mL of deionized water.

Write name of preparer, preparation date, reagent manufacturer, manufacturer lot number in the Analytical Reagent log book. The reagent is stable for six months.

7.4 Copper Sulfate Reagent, 2% –

Copper sulfate (CuSO ₄ ·5H ₂ O)	2 g
Deionized water	up to 100 ml

In a 100 mL volumetric flask, dissolve 2 g of copper sulfate in ~80 mL of deionized water. Dilute to 100 mL with deionized water. Write name of preparer, preparation date, reagent manufacturer, manufacturer lot number in the Analytical Reagent log book. The reagent is stable for six months.

7.5 Ammonium Chloride Reagent –

Ammonium Chloride (NH ₄ Cl)	10 g
Alkaline water	up to 1000 mL
Copper Sulfate Reagent, 2%	6 drops

In a 1000 ml volumetric flask, dissolve 10 g of concentrated ammonium chloride to ~800 ml of Alkaline Water. Dilute to 1000 mL with Alkaline Water. Attain a pH balance of 8.5. Add 6 drops of Copper Sulfate Reagent, 2%. Write name of preparer, preparation date, reagent manufacturer, manufacturer lot number in the Analytical Reagent log book. The reagent is stable for six months.

7.6 Color Reagent –

Sulfanilamide (C ₆ H ₈ N ₂ O ₂ S)	20 g
Phosphoric Acid (H ₃ PO ₄), concentrated (80%)	200 mL
N-1-naphthylethylenediamine dihydrochloride (C ₁₂ H ₁₄ N ₂ ·2HCl)	1 g
Deionized water	up to 2000 mL
Brij-35, 30%	1 mL

In a 2000 mL volumetric flask, add 200 mL concentrated phosphoric acid and 20 g of sulfanilamide to ~1500 mL deionized water. Dissolve completely. Add 1 g of N-1-naphthylethylenediamine dihydrochloride and dissolve. Dilute to 2000 ml with deionized water and add 1 mL of 30% Brij-35. Write name of preparer, preparation date, reagent manufacturers,

manufacturers' lot numbers in the Analytical Reagent log book. Make fresh every 6 weeks. Store at 4°C.

7.7 Nitrate Stock Standard, 5000 μM –

Potassium nitrate (KNO_3), primary standard grade, dried at 45°C

0.5055 g

Deionized water

up to 1000 mL

In a 1000 mL volumetric flask, dissolve 0.5055 g of potassium nitrate in ~800 mL of deionized water. Dilute to 1000 mL with deionized water (1 mL contains 5 $\mu\text{moles N}$). Write name of preparer, preparation date, standard manufacturer, manufacturer lot number in the Analytical Standard log book. Make fresh every 4 months.

7.8 Secondary Nitrate Standard –

Stock Nitrate Standard

0.80 mL

Deionized water

up to 100 mL

In a volumetric flask, dilute 0.80 mL of Stock Nitrate Standard to 100 mL with deionized water to yield a concentration of 40 $\mu\text{M NO}_3^-/\text{L}$ (0.56 mg N/L). Write name of preparer, preparation date, standard manufacturer, manufacturer lot number in the Analytical Standard log book. Make fresh every 4 weeks.

7.9 Working Nitrate Standard – Dilute 1, 2, 5, 8 and 10 mL of Secondary Standard to 100 mL with deionized water to yield concentrations of 0.4 $\mu\text{M N}$ (0.0056 mg N/L), 0.8 $\mu\text{M N}$ (0.0112 mg N/L), 2.0 $\mu\text{M N}$ (0.028 mg N/L), 3.2 $\mu\text{M N}$ (0.0448 mg N/L) and 4.0 $\mu\text{M N}$ (.056 mg N/L). Write name of preparer, preparation date, standard manufacturer, manufacturer lot number in the Analytical Standard log book. Make fresh every 4 weeks.

7.10 Stock Nitrite Standard –

Sodium nitrite (NaNO_2), primary standard grade, dried at 45°C

0.345 g

Deionized water

up to 1000 mL

In a 1000 mL volumetric flask, dissolve 0.345 g of sodium nitrite in ~800 mL of deionized water. Dilute to 1000 mL with deionized water (1 mL contains 5 $\mu\text{moles N}$). Add 1 mL of chloroform as a preservative. Write name of preparer, preparation date, standard manufacturer, manufacturer lot number in the Analytical Standard log book. Make fresh every 4 months.

7.11 Secondary Nitrite Standard –

Stock Nitrite Standard

0.80 mL

Deionized water

up to 100 mL

In a volumetric flask, dilute 0.80 mL of Stock Nitrite Standard to 100 mL with deionized water to yield a concentration of 40 $\mu\text{M NO}_2^-/\text{L}$ (0.56 mg N/L). Write name of preparer, preparation date, standard

manufacturer, manufacturer lot number in the Analytical Standard log book. Make fresh every 4 weeks.

8 SAMPLE COLLECTION, PRESERVATION, AND STORAGE

8.1 Water collected for NO₃+NO₂ should be filtered through a Whatman GF/F glass fiber filter (nominal pore size 0.7 μm), or equivalent.

8.2 Water collected for NO₃+NO₂ should be frozen at -20° C. The AutoAnalyzer vial container should be clean and sample rinsed.

8.3 Frozen NO₃+NO₂ samples may be stored up to 28 days. It has been shown that frozen QCS samples up to a year old still fall well within the control limits.

8.4 NO₃+NO₂ samples may be refrigerated at 4° C for no longer than one day.

9 QUALITY CONTROL

9.1 The laboratory is required to operate a formal quality control (QC) program.

The minimum requirements of this program consist of an initial demonstration of laboratory capability and the continued analysis of laboratory instrument blanks and calibration standard material, analyzed as samples, as a continuing check on performance. The laboratory is required to maintain performance records that define the quality of data generated.

9.2 Initial Demonstration of Capability

9.2.1 The initial demonstration of capability (NO₃+NO₂) – is used to characterize instrument performance (MDLs) and laboratory performance (analysis of QC samples) prior to the analyses conducted by this procedure.

9.2.2 Linear Dynamic Range – LDR (Linear Calibration Range) should be established for NO₃+NO₂ using appropriate calibration curve of a blank and five standards.

9.2.3 Quality Control Sample (QCS/SRM) – When using this procedure, a quality control sample is required to be analyzed at the beginning and end of the run, to verify data quality and acceptable instrument performance. If the determined concentrations are not within ± 10% of the certified values, performance of the determinative step of the method is unacceptable. The source of the problem must be identified and corrected before either proceeding with the initial determination of MDLs or continuing with analyses.

9.2.4 Method Detection Limits (MDLs) – MDLs should be established for NO₃+NO₂ using a low level ambient water sample. To determine the MDL values, analyze seven replicate aliquots of water. Perform all calculations defined in the procedure (Section xx) and report the concentration values in the appropriate units. Calculate the MDL as follows:

$$\text{MDL} = s_x 3$$

Where, s = Standard Deviation of the replicate analyses.

- 9.2.5 MDLs shall be determined yearly and whenever there is a significant change in instrument response, a significant change in instrument configuration, or a new matrix is encountered.

9.3 Assessing Laboratory Performance

- 9.3.1 Laboratory Reagent Blank (LRB) – The laboratory must analyze at least one LRB with each batch of samples. The LRB consists of Nanopure water treated the same as the samples. Analyte found in LRB indicates possible reagent or laboratory environment contamination. LRB data are used to assess and correct contamination from the laboratory environment. LRB above the MDL requires that the source of the problem must be identified and corrected before proceeding with analyses.
- 9.3.2 Quality Control Sample (QCS)/ Standard Reference Material (SRM) – When using this procedure, a quality control sample is required to be analyzed at the beginning of the run and end of the run, to verify data quality and acceptable instrument performance. If the determined concentrations are not within $\pm 3\sigma$ of the certified values, performance of the determinative step of the method is unacceptable. The source of the problem must be identified and corrected before either proceeding with the initial determination of MDLs or continuing with the analyses. The results of these QCS/SRM samples shall be used to determine batch acceptance.
- 9.3.3 The QCS are obtained from a source external to the laboratory and different from the source of calibration standards.
- 9.3.4 Control Charts – The Accuracy Control Chart for QCS/SRM samples is constructed from the average and standard deviation of the 20 most recent QCS/SRM measurements. The accuracy chart includes upper and lower warning levels ($WL = \pm 2s$) and upper and lower control levels ($CL = \pm 3s$). These values are derived from stated values of the QCS/SRM. The standard deviation (s) is specified relative to statistical confidence levels of 95% for WLs and 99% for CLs. Set up an accuracy chart by using percent recovery since the concentration of the QCS/SRM varies. Enter QCS/SRM results on the chart each time the sample is analyzed
- 9.3.5 Continuing Calibration Verification (CCV) – Following every 18-23 samples, one CCV of $4.0 \mu\text{M NO}_3$ (.056 mg N/L) is analyzed to assess instrument performance. The CCVs are made from the same material as calibration standards (KNO_3), and are to be within $\text{TV} \pm 3\sigma$. Failure to meet the criteria requires correcting the problem, including reanalysis of any affected samples. If not enough sample exists, the data must be qualified if reported.

- 9.3.6 Reduction Efficiency Verification (REV) – The REVs are made from NaNO_2 , 40 μM NO_2 (0.56 mg N/L) and are to be within $\text{TV} \pm 3s$ of the equivalent CCV, 40 μM NO_3 (0.56 mg N/L). Failure to meet the criteria requires correcting the problem.
- 9.3.7 Reagent Blank – The Reagent Blank Control Chart for Reagent Blank samples is constructed from the average and standard deviation of the 20 most recent Reagent Blank measurements. The accuracy chart includes upper and lower warning levels ($\text{WL} = \pm 2s$) and upper and lower control levels ($\text{CL} = \pm 3s$). The standard deviation (s) is specified relative to statistical confidence levels of 95% for WLs and 99% for CLs. Enter Reagent Blank results on the chart each time the Reagent Blank is analyzed.
- 9.4 Assessing Analyte Recovery - % Recovery
- 9.4.1 Analyte recovery is assessed through percent recoveries of laboratory spikes of samples.
- 9.4.2 % Recovery = $(\text{Spiked sample concentration} - \text{Sample concentration} / \text{Concentration of spike solution}) \times 100$
- 9.5 Assessing Analyte Precision – Relative Percent Difference (RPD)
- 9.5.1 Analyte replication is assessed through duplicate analyses of samples – Relative Percent Difference.
- 9.5.2 $\text{RPD} = (\text{Laboratory Duplicate Result 1} - \text{Laboratory Duplicate Result 2}) / [(\text{Laboratory Duplicate Result 1} + \text{Laboratory Duplicate Result 2}) / 2] \times 100$
- 9.6 Corrective Actions for Out of Control Data
- 9.6.1 Control limit – If one measurement exceeds Accuracy Control Chart CL, repeat the analysis immediately. If the repeat measurement is within the CL, continue analyses; if it exceeds the CL, discontinue analyses and correct the problem.
- 9.6.2 Warning limit – If two out of three successive points exceed Accuracy Control Chart WL, analyze another sample. If the next point is within WL, continue analyses; if the next point exceeds the WL, evaluate potential bias and correct the problem.
- 9.6.3 Trending – If seven successive Accuracy Control Chart measurements are on the same side of the central line, discontinue analyses and correct the problem.
- 9.6.4 When external QCS samples are out of control, correct the problem. Reanalyze the samples analyzed between the last in-control measurement and the out-of-control one.
- 9.6.5 When external CCV samples are out of control, correct the problem. Reanalyze the samples analyzed between the last in-control measurement and the out-of-control one.

- 9.7 General Operation - To assure optimal operation and analytical results, the Reagent Blank and CCV are tracked daily in the raw data file, copied to Reagent Blank and CCV Control Charts.

10 CALIBRATION AND STANDARDIZATION

- 10.1 Calibration – Daily calibration must be performed before sample analysis may begin. Six point calibrations are used with the Technicon Bran & Luebbe AutoAnalyzer II. Type I water is used as the “zero point” in the calibration.
- 10.2 Working Nitrate Standards – Dilute Dilute 1, 2, 5, 8 and 10 mL of Secondary Standard to 100 mL with deionized water to yield concentrations of 0.4 $\mu\text{M N}$ (0.0056 mg N/L), 0.8 $\mu\text{M N}$ (0.0112 mg N/L), 2.0 $\mu\text{M N}$ (0.028 mg N/L), 3.2 $\mu\text{M N}$ (0.0448 mg N/L) and 4.0 $\mu\text{M N}$ (0.056 mg N/L).
- 10.3 Prepare standard curve by plotting response on recorder of each and every standard processed through the manifold against NO_3^- N/L concentration in standards.
- 10.4 Compute sample $\text{NO}_3 + \text{NO}_2^-$ N/L concentration by comparing sample response on recorder with standard curve. If NO_3^- N/L concentration is required, subtract NO_2^- N/L concentration from $\text{NO}_3 + \text{NO}_2^-$ N/L concentration.

11 PROCEDURE – NEW REDUCTION COLUMN PREPARATION

- 11.1 Prepare Copper-Cadmium Column – Use good quality cadmium filings of 25-60 mesh size.
- 11.2 Clean 10 g of cadmium with 20 mL of acetone. Rinse twice with 20 mL of deionized water. Next, clean cadmium with 50 mL of 1 N Hydrochloric Acid for 1 minute. Cadmium turns silver in color. Decant Hydrochloric Acid and wash the cadmium with another 50 mL of 1 N Hydrochloric Acid for 1 minute.
- 11.3 Decant 1 N Hydrochloric Acid and wash the cadmium several times with deionized water.
- 11.4 Decant deionized water and add 20 mL of 2% (w/v) Copper Sulfate ($\text{CuSO}_4 \cdot 5\text{H}_2\text{O}$). Wash the cadmium until no blue color remains in the solution.
- 11.5 Decant Copper Sulfate solution and add another 20 mL of 2% (w/v) Copper Sulfate ($\text{CuSO}_4 \cdot 5\text{H}_2\text{O}$). Wash the cadmium until no blue color remains in the solution. The cadmium will be dark brown in color.
- 11.6 Decant Copper Sulfate solution and wash thoroughly (~10 times) with deionized water.
- 11.7 Set up Manifold, following general procedure of manufacturer in the following prescribed order.
- 11.8 Insert a glass wool plug at the outlet end of the column. Fill the reductor column tubing (22 cm length of 0.110-inch ID Tygon tubing) with Ammonium Chloride Reagent and transfer the prepared cadmium granules to the column using a Pasteur pipette or some other method that prevents contact of cadmium granules with air. Do not allow any air bubbles to be trapped in

- column. Pack entire column uniformly with filings such that, visually, the packed filings have separation gaps $\leq \sim 1$ mm.
- 11.9 Ammonium Chloride Reagent initiates analytical sample stream from 1.20 mL/min Yellow/Yellow pump tube.
 - 11.10 Air is injected from 0.32 mL/min Black/Black pump tube.
 - 11.11 Sample is added from 0.32 mL/min Black/Black pump tube.
 - 11.12 Mixing occurs in five turn coil.
 - 11.13 Air bubbles are de-bubbled from analytical sample stream using 0.60 mL/min Red/Red pump tube.
 - 11.14 De-bubbled analytical sample stream passes through 22 cm reductor column.
 - 11.15 Air is injected from 0.32 mL/min Black/Black pump tube.
 - 11.16 Color Reagent is added from 0.32 mL/min Black/Black pump tube.
 - 11.17 Mixing occurs in twenty-two turn coil.
 - 11.18 Analytical sample stream enters 1.5 mm ID, 50 mm long Flow Cell pulled by 0.80 mL/min waste line. Bubbles and remainder of sample stream exit by gravity.
 - 11.19 Color of analytical sample stream is quantitatively read at 550 nm by Colorimeter with 199-B021-01 Phototube, electronic output recorded on strip chart of Recorder.
 - 11.20 Attach pump tubes to end rails of Proportioning Pump. Put platen on Proportioning Pump. With deionized water running through the sample line and Ammonium Chloride Reagent running through its designated line, attach the column. Make sure there are no air bubbles in the valve and attach the column to the intake side of the valve first. Open the valve to allow Ammonium Chloride Reagent stream to flow through the column. Allow deionized water to run through the Color Reagent line.
 - 11.21 Turn on Colorimeter and Recorder.
 - 11.22 Check for good flow characteristics (good bubble pattern) after insertion of air bubbles beyond the column. If the column is packed too tightly, an inconsistent flow pattern will result. Allow Ammonium Chloride Reagent to flow through Column, manifold and Colorimeter for one hour.
 - 11.23 At conclusion of that hour, condition the column with approximately 100 mg N/L (KNO_3) for 5 minutes, followed by approximately 100 mg N/L (NaNO_2) for 5 minutes. Turn Baseline Knob on Colorimeter to obtain 0 deflection on Recorder.
 - 11.24 Attach Color Reagent line to Color Reagent. At Colorimeter Standard Calibration setting of 1.00, note deflection on Recorder. Reject Color Reagent if deflection is more than 8 out of total 100 chart units. Turn Baseline Knob on Colorimeter to obtain 0 deflection on Recorder.
 - 11.25 At Colorimeter Standard Calibration setting of 1.00, analyze Secondary Nitrate Standard ($40 \mu\text{M NO}_3^-$ -N/L (0.56 mg N/L)) and Secondary Nitrite Standard ($40 \mu\text{M NO}_2^-$ -N/L (0.56 mg N/L)). If peak height of Secondary Nitrate Standard is $<90\%$ of peak height of Secondary Nitrite Standard, prepare new cadmium reduction column.

- 11.26 Set Colorimeter Standard Calibration setting at 9.00. Analyze Working Nitrate Standards. Prepare standard curve by plotting response on recorder of standards processed through the manifold against NO_3 -N/L concentration in standards.
- 11.27 Analyze samples. Compute sample NO_3 -N/L concentration by comparing sample response on Recorder with standard curve.
- 11.28 At the end of the run, at Colorimeter Standard Calibration setting 1.00, analyze Secondary Nitrate Standard ($40 \mu\text{M NO}_3$ -N/L (0.56 mg N/L)) and Secondary Nitrite Standard ($40 \mu\text{M NO}_2$ -N/L (0.56 mg N/L)). If peak height of Secondary Nitrate Standard is <90% of peak height of Secondary Nitrite Standard, reject all sample concentrations and prepare a new cadmium reduction column.
- 11.29 Allow deionized water to flow through the sample line for 10 minutes. Close the valve to the column, diverting flow. Allow deionized water to flow through sample, Ammonium Chloride and Color Reagent lines for one minute. Turn Proportioning Pump switch to fast pump for its allotted time.
- 11.30 Turn off Sampler, Colorimeter and Recorder. Release and remove Proportioning Pump platen. Release pump tube holders from end rails.

12 PROCEDURE – DAILY OPERATION

- 12.1 Attach pump tubes to end rails of Proportioning Pump. Put platen on Proportioning Pump. Allow deionized water to run through the sample line, Ammonium Chloride Reagent to run through its line and deionized water to run through the Color Reagent line. Check for good flow characteristics (good bubble pattern). Open the valve to allow Ammonium Chloride Reagent stream to flow through the column.
- 12.2 Turn on Colorimeter and Recorder. Set Colorimeter Standard Calibration setting to 1.00. Let liquid pump through the column, Manifold and Colorimeter for one hour.
- 12.3 At the conclusion of that hour, turn Baseline Knob on Colorimeter to obtain 0 deflection on Recorder.
- 12.4 Attach Color Reagent line to the Color Reagent. At a Colorimeter Standard Calibration setting of 1.00, note deflection on the Recorder. Reject Color Reagent if deflection is more than 8 out of total 100 chart units. Turn Baseline Knob on the Colorimeter to obtain 0 deflection on Recorder.
- 12.5 At Colorimeter Standard Calibration setting 1.00, analyze Secondary Nitrate Standard ($40 \mu\text{M NO}_3$ -N/L (0.56 mg N/L)) and Secondary Nitrite Standard ($40 \mu\text{M NO}_2$ -N/L (0.56 mg N/L)). If the peak height of Secondary Nitrate Standard is <90% of the peak height of Secondary Nitrite Standard, prepare a new cadmium reduction column.
- 12.6 Set Colorimeter Standard Calibration setting at 9.00. Analyze Working Nitrate Standards. Prepare standard curve by plotting response on recorder of standards processed through the manifold against NO_3 -N/L concentration in standards in Excel.
- 12.7 Analyze samples. Compute sample NO_3 -N/L concentration by comparing sample response on Recorder with standard curve in Excel.

- 12.8 At the end of the run, at a Colorimeter Standard Calibration setting of 1.00, analyze Secondary Nitrate Standard (40 μM NO_3^- /L (0.56 mg N/L)) and Secondary Nitrite Standard (40 μM NO_2^- /L (0.56 mg N/L)). If the peak height of Secondary Nitrate Standard is <90% of the peak height of Secondary Nitrite Standard, reject all sample concentrations and prepare a new cadmium reduction column.
- 12.9 Allow deionized water to flow through the sample line for 10 minutes. Close the valve to the column, diverting flow. Allow deionized water to flow through the sample, Ammonium Chloride and Color Reagent lines for one minute. Turn Proportioning Pump switch to fast pump for its allotted time.
- 12.10 Turn off Sampler, Colorimeter and Recorder. Release and remove Proportioning Pump platen. Release pump tube holders from end rails.

13 REFERENCES

- 13.1 Technicon Industrial Method No. 158-71 W/A Tentative. 1977. Technicon Industrial Systems. Tarrytown, New York, 10591.
- 13.2 USEPA. 1979. Method No. 353.2 *in* Methods for chemical analysis of water and wastes. United States Environmental Protection Agency, Office of Research and Development. Cincinnati, Ohio. Report No. EPA-600/4-79-020 March 1979. 460pp.

Determination of Dissolved Inorganic Nitrate plus Nitrite (NO₃+NO₂) in Fresh/Estuarine/Coastal Waters Using Enzyme Catalyzed Reduction

1. SCOPE and APPLICATION

- 1.1 Enzyme catalyzed reduction is used to quantitatively reduce dissolved nitrate to nitrite which is then measured by colorimetric quantitative analysis of a highly colored azo dye. The method is used to analyze all ranges of salinity.
- 1.2 A Method Detection Limit (MDL) of 0.005 mg NO₃+NO₂-N/L was determined as three times the standard deviation of seven low level replicates.
- 1.3 The Quantitation Limit for NO₃+NO₂ was set at 0.0175 mg NO₃+NO₂-N/L, or ten times the standard deviation of the MDL calculation.
- 1.4 The method is suitable NO₃+NO₂ concentrations 0.0175 to 5.6 mg NO₃+NO₂-N/L.
- 1.5 This procedure should be used by analysts experienced in the theory and application of aqueous inorganic analysis. Three months experience with an experienced analyst, certified in the analysis of nitrate plus nitrite in aqueous samples by enzyme catalyzed reduction is required.
- 1.6 This method can be used for all programs that require analysis of dissolved inorganic nitrate plus nitrite.

2. SUMMARY

2.1 Filtered samples are mixed with Nitrate Reductase (an enzyme isolated from the plant *Arabidopsis thaliana*) and NADH (β -Nicotinamide adenine dinucleotide reduced form disodium salt). The nitrite, both that which was reduced from nitrate and nitrite that was originally present, is then determined by diazotizing with sulfanilamide and coupling with N-1-naphthylethylenediamine dihydrochloride to form a colored azo dye. Filtered samples with concentrations found to be below the method detection limit are analyzed via cadmium reduction with a Technicon Bran & Luebbe AutoAnalyzer II.

3. DEFINITIONS

- 3.1 Acceptance Criteria – Specified limits placed on characteristics of an item, process, or service defined in a requirement document. (ASQC)
- 3.2 Accuracy – The degree of agreement between an observed value and an accepted reference value. Accuracy includes a combination of random error (precision) and systematic error (bias) components which are due to sampling and analytical operations; a data quality indicator. (QAMS)

- 3.3 Aliquot – A discrete, measured, representative portion of a sample taken for analysis. (EPA QAD Glossary)
- 3.4 Analytical Range – 0.035 to 5.6 mg NO₃+NO₂-N/L. The overall analytical range is comprised of three distinct yet overlapping concentration ranges. A separate calibration is performed for each range. These ranges include 0.035 to 0.28 mg NO₃+NO₂-N/L, 0.07 to 0.70 mg NO₃+NO₂-N/L and 0.56 to 5.6 mg NO₃+NO₂-N/L. Three sub-ranges are utilized so that samples can be analyzed on the most appropriate scale possible.
- 3.5 Batch – Environmental samples, which are prepared and /or analyzed together with the same process and personnel, using the same lot(s) of reagents. A **preparation batch** is composed of one to 200 environmental samples of the same matrix, meeting the above mentioned criteria and with a maximum time between the start of processing of the first and last sample in the batch to be 8 hours. An **analytical batch** is composed of prepared environmental samples (extracts, digestates, concentrates) and/or those samples not requiring preparation, which are analyzed together as a group using the same calibration curve or factor. An analytical batch can include samples originating from various environmental matrices and can exceed 20 samples. (NELAC/EPA)
- 3.6 Blank- A sample that has not been exposed to the analyzed sample stream in order to monitor contamination during sampling, transport, storage or analysis. The blank is subjected to the usual analytical and measurement process to establish a zero baseline or background value and is sometimes used to adjust or correct routine analytical results. (ASQC)
- 3.7 Calibrate- To determine, by measurement or comparison with a standard, the correct value of each scale reading on a device. The levels of the applied calibration standard should bracket the range of planned or expected sample measurements. (NELAC)
- 3.8 Calibration – The set of operations which establish, under specified conditions, the relationship between values indicated by a measuring device. The levels of the applied calibration standard should bracket the range of planned or expected sample measurements. (NELAC)
- 3.9 Calibration Blank – A volume of reagent water fortified with the same matrix as the calibration standards, without analyte added.
- 3.10 Calibration Curve – The graphical relationship between known values, such as concentrations, or a series of calibration standards and their analytical response. (NELAC)
- 3.11 Calibration Method – A defined technical procedure for performing a calibration. (NELAC)
- 3.12 Calibration Standard – A substance or reference material used to calibrate an instrument. (QAMS)
- 3.12.1 Initial Calibration Standard (STD) – A series of standard solutions used to initially establish instrument calibration

- responses and develop calibration curves for individual target analytes.
- 3.12.2 Initial Calibration Verification (ICV) – An individual standard, distinct from the Initial Calibration Standards (STD), analyzed initially, prior to any sample analysis, which verifies acceptability of the calibration curve or previously established calibration curve.
 - 3.12.3 Continuing Calibration Verification (CCV) – An individual standard, distinct from the Initial Calibration Standards (STD), analyzed after every 15-20 field sample analyses.
- 3.13 Certified Reference Material – A reference material one or more of whose property values are certified by a technically valid procedure, accompanied by or traceable to a certificate or other documentation which is issued by a certifying body. (ISO 17025)
 - 3.14 Corrective Action – Action taken to eliminate the causes of an existing nonconformity, defect or other undesirable situation in order to prevent recurrence. (ISO 8402)
 - 3.15 Deficiency – An unauthorized deviation from acceptable procedures or practices. (ASQC)
 - 3.16 Demonstration of Capability – A procedure to establish the ability of the analyst to generate acceptable accuracy. (NELAC)
 - 3.17 Detection Limit – The lowest concentration or amount of the target analyte that can be determined to be different from zero by a single measurement at a stated degree of confidence.
 - 3.18 Duplicate Analysis – The analyses of measurements of the variable of interest performed identically on two sub samples (aliquots) of the same sample. The results from duplicate analyses are used to evaluate analytical or measurement precision but not the precision of sampling, preservation or storage internal to the laboratory. (EPA-QAD)
 - 3.19 External Standard (ES) – A pure analyte (potassium nitrate (KN O₃)) that is measured in an experiment separate from the experiment used to measure the analyte(s) in the sample. The signal observed for a known quantity of the pure external standard is used to calibrate the instrument response for the corresponding analyte(s). The instrument response is used to calculate the concentrations of the analyte(s) in the unknown sample.
 - 3.20 Field Duplicates (FD1 and FD2) – Two separate samples collected at the same time and place under identical circumstances and treated exactly the same throughout field and laboratory procedures. Analyses of FD1 and FD2 provide a measure of the precision associated with sample collection, preservation and storage, as well as with laboratory procedures.
 - 3.21 Holding time – The maximum time that samples may be held prior to analysis and still be considered valid. (40 CFR Part 136) The time elapsed from the time of sampling to the time of extraction or analysis, as appropriate.

- 3.22 Laboratory Duplicates (LD1 and LD2) – Two aliquots of the same sample taken in the laboratory and analyzed separately with identical procedures. Analyses of LD1 and LD2 indicate precision associated with laboratory procedures, but not with sample collection, preservation, or storage procedures.
- 3.23 Laboratory Reagent Blank (LRB) – A blank matrix (i.e., DI water) that is treated exactly as a sample including exposure to all glassware, equipment, solvents, and reagents that are used with other samples. The LRB is used to determine if method analytes or other interferences are present in the laboratory environment, the reagents, or the instrument.
- 3.24 Laboratory Control Sample (LCS) – A sample matrix, free from the analytes of interest, spiked with verified known amounts of analytes from a source independent of the calibration standard or a material containing known and verified amounts of analytes. The LCS is generally used to establish intra-laboratory or analyst-specific precision and bias or to assess the performance of all or a portion of the measurement system. (NELAC)
- 3.25 Limit of Detection (LOD) – The lowest concentration level that can be determined by a single analysis and with a defined level of confidence to be statistically different from a blank. (ACS)
- 3.26 Limit of Quantitation (LOQ) – The minimum levels, concentrations, or quantities of a target variable (target analyte) that can be reported with a specified degree of confidence. The LOQ is set at 3 to 10 times the LOD, depending on the degree of confidence desired.
- 3.27 Linear Dynamic Range (LDR) – The absolute quantity over which the instrument response to an analyte is linear. This specification is also referred to as the Linear Calibration Range (LCR).
- 3.28 Material Safety Data Sheets (MSDS) – Written information provided by vendors concerning a chemical's toxicity, health hazards, physical properties, fire, and reactivity data including storage, spill, and handling precautions.
- 3.29 May – Denotes permitted action, but not required action. (NELAC)
- 3.30 Method Detection Limit (MDL) – The minimum concentration of an analyte that can be identified, measured, and reported with 99% confidence that the analyte concentration is greater than zero (Standard Methods).
- 3.31 Must – Denotes a requirement that must be met. (Random House College Dictionary)
- 3.32 Photometer – measures the absorbance of the solution in the cell in a multicell cuvette. Light passes from the lamp through the condensing lenses to the interference filter. The plane surface of the first condensing lens is coated with a material which reflects heat and infrared light. The filters are mounted on a filter wheel. There are 15

positions for filters. Each filter corresponds to a wavelength of interest. The 540 nm filter is specified by the test definition for nitrate plus nitrite. After passing through the filter the light is converted into a stream of light pulses by a chopper. Then the light is directed via a quartz fiber through a focusing lens and a slit to the beam divider. The beam divider divides the light into two parts. A specified portion is reflected to the reference detector, which monitors the light level fluctuations. The remaining major portion of the light beam goes through the liquid in the cell to the signal detector, which measures the amount of light absorbed.

- 3.33 Precision – The degree to which a set of observations or measurements of the same property, obtained under similar conditions, conform to themselves; a data quality indicator. Precision is usually expressed as standard deviation, variance or range, in either absolute or relative terms. (NELAC)
- 3.34 Preservation – Refrigeration, freezing, and/or reagents added at the time of sample collection (or later) to maintain the chemical and or biological integrity of the sample.
- 3.35 Quality Control Sample (QCS) – A sample of analyte of known and certified concentration. The QCS is obtained from a source external to the laboratory and different from the source of calibration standards. It is used to check laboratory performance with externally prepared test materials.
- 3.36 Run Cycle – Typically a day of operation – the entire analytical sequence from sampling the first standard to the last sample of the day.
- 3.37 Sample Segment – Bar-coded metal tray that holds up to fourteen four milliliter auto analyzer vials containing samples or standards. The user identifies each vial in the operating software.
- 3.38 Sample Segment Holder – An automated temperature controlled carousel that contains up to six sample segments. This carousel spins in clockwise or counterclockwise manner to move the sample segments into position for analysis. This carousel format allows for continuous processing.
- 3.39 Sensitivity – The capability of a test method or instrument to discriminate between measurement responses representing different levels (concentrations) of a variable of interest.
- 3.40 Shall – Denotes a requirement that is mandatory whenever the criterion for conformance with the specification requires that there be no deviation. (ANSI)
- 3.41 Should – Denotes a guideline or recommendation whenever noncompliance with the specification is permissible. (ANSI)
- 3.42 Standard Reference Material (SRM) – Material which has been certified for specific analytes by a variety of analytical techniques and/or by numerous laboratories using similar analytical techniques. These may consist of pure chemicals, buffers, or compositional

standards. The materials are used as an indication of the accuracy of a specific analytical technique.

3.43 Test Definition – A photometric test consisting of a user defined testing sequence, reagent additions, calibration standards, incubations and absorption results.

3.44 Test Flow – Functions to define the parameter for reagent and sample dispensing, dilution, incubation and measurement.

4 INTERFERENCES

4.1 Suspended matter in the sample will scatter light as it passes through the cuvette to the detector. High blank responses will result. The identified sample will be reanalyzed.

4.2 Blemishes in the cuvette, as result of the manufacturing process, will result in high blank responses. The identified sample will be reanalyzed.

5 SAFETY

5.1 Safety precautions must be taken when handling reagents, samples and equipment in the laboratory. Protective clothing including lab coats, safety glasses and enclosed shoes should be worn. In certain situations, it will be necessary to also use gloves and/or a face shield. If solutions come in contact with eyes, flush with water continuously for 15 minutes. If solutions come in contact with skin, wash thoroughly with soap and water. Contact Solomons Rescue Squad (911) if emergency treatment is needed and also inform the CBL Business Manager of the incident. Contact the CBL Business Manager if additional treatment is required.

5.2 The toxicity or carcinogenicity of each reagent used in this procedure may not have been fully established. Each chemical should be regarded as a potential health hazard and exposure should be as low as reasonably achievable. Cautions are included for known hazardous materials and procedures.

5.3 Do not wear jewelry when troubleshooting electrical components. Even low voltage points are dangerous and can injure if allowed to short circuit.

5.4 The following hazard classifications are listed for the chemicals used in this procedure. Detailed information is provided on Material Safety Data Sheets (MSDS).

Chemical	Health	Flammability	Reactivity	Contact	Storage
Nitrate Reductase (AtNaR2) from <i>Arabidopsis thaliana</i>	0	0	0	0	Green
NADH (β -Nicotinamide adenine dinucleotide reduced form disodium salt)	0	0	0	0	Green
Potassium hydroxide	3	0	2	4	White

					Stripe
Sulfanilamide	0	1	1	1	Green
N-1-naphthylethylenediamine dihydrochloride	2	1	1	2	Green
Hydrochloric Acid	3	0	2	4	White
Potassium nitrate	2	0	3	2	Yellow
Sodium nitrite	2	0	3	2	Yellow
Potassium phosphate	0	0	0	1	Green
EDTA (Ethylenediamine tetraacetic acid)	1	0	0	1	Green

On a scale of 0 to 4 the substance is rated on four hazard categories: health, flammability, reactivity, and contact. (0 is non-hazardous and 4 is extremely hazardous)

STORAGE

Red – Flammability Hazard: Store in a flammable liquid storage area.

Blue – Health Hazard: Store in a secure poison area.

Yellow – Reactivity Hazard: Keep separate from flammable and combustible materials.

White – Contact Hazard: Store in a corrosion-proof area.

Green – Use general chemical storage (On older labels, this category was orange).

Striped – Incompatible materials of the same color class have striped labels. These products should not be stored adjacent to substances with the same color label. Proper storage must be individually determined.

6 EQUIPMENT AND SUPPLIES

6.1 Aquakem 250 multi-wavelength automated discrete photometric analyzer.

Aquakem 250 control software operates on a computer running Microsoft Windows NT or XP operating system.

6.2 Freezer, capable of maintaining $-20 \pm 5^\circ \text{C}$.

6.3 Lab ware – All reusable lab ware (glass, Teflon, plastic, etc) should be sufficiently clean for the task objectives. This laboratory cleans all lab ware related to this method with a 10% HCl (v/v) acid rinse.

7 REAGENTS AND STANDARDS

7.1 Purity of Water – Unless otherwise indicated, references to water shall be understood to mean reagent water conforming to Specification D 1193, Type I. Freshly prepared water should be used for making the standards intended for calibration. The detection limits of this method will be limited by the purity of the water and reagents used to make the standards.

7.2 Purity of Reagents – Reagent grade chemicals shall be used in all tests. Unless otherwise indicated, it is intended that all reagents shall conform to specifications of the Committee on Analytical Reagents of the American Chemical Society, where such specifications are available. Other grades may be used, provided it is

first ascertained that the reagent is of sufficiently high purity to permit its use without compromising the accuracy of the determination.

7.3 Ethylenediamine tetraacetic acid (EDTA, 25 mM) 9.3 g

In a 1 L volumetric flask add approximately 800 mL deionized water. Dissolve 9.3 g ultrapure EDTA in deionized water and bring to volume. Write name of preparer, preparation date, reagent manufacturer, manufacturer's lot number in the Analytical Reagent log book. Store the flask at room temperature out of direct sunlight. The reagent is stable for one year.

7.4 Phosphate Buffer-

Potassium di-hydrogen phosphate (KH ₂ PO ₄)	1.88 g
Potassium hydroxide (KOH)	0.7 g
EDTA (25 mM)	5.0 mL

In a 500mL volumetric flask dissolve 1.88 g KH₂PO₄, 0.7g KOH and 5.0 mL EDTA (25mM) in approximately 400 mL deionized water. Bring flask to volume. Store flask at room temperature. Write name of preparer, preparation date, reagent manufacturers, manufacturers' lot numbers in the Analytical Reagent log book. The reagent is stable for six months.

7.5 Nitrate Reductase (AtNaR2)-

Nitrate reductase from <i>Arabidopsis Thaliana</i>	3.0 unit vial
Phosphate Buffer	20 mL

Transfer 1mL phosphate buffer to the 3.0 unit vial of AtNaR2 to affect dissolution. Shake several times over a thirty minute period. Transfer this to the 20mL reagent bottle quantitatively with four 1 ml aliquots of the phosphate buffer. Add 15mL of phosphate buffer to the reagent bottle. Shake bottle to complete the reagent preparation. This is enough reagent for approximately 300 analyses. Write name of preparer, preparation date, reagent manufacturers, manufacturers' lot numbers in the Analytical Reagent log book. This reagent is stable for eight hours in the refrigerated reagent compartment of the instrument.

7.6 NADH-

(β -Nicotinamide adenine dinucleotide reduced form disodium salt)	2.4 g vial
Phosphate Buffer	11 mL

Carefully transfer NADH crystals from vial to 20 mL reagent bottle. Place 1 mL phosphate buffer in vial and shake thoroughly. Transfer to reagent bottle. Add 10 mL phosphate buffer to the reagent bottle. Shake to complete reagent preparation. This is enough reagent for approximately 300 analyses. Write name of preparer, preparation date, reagent manufacturers, manufacturers' lot numbers in the Analytical Reagent log book. This reagent is stable for eight hours in the refrigerated reagent compartment of the instrument.

7.7 Sulfaniamide-

Sulfanilamide	10 g
Hydrochloric Acid (concentrated)	300 mL

Add 500 mL deionized water to a 1 L volumetric flask. Carefully add 300 mL concentrated hydrochloric acid to the flask. Then add 10 g sulfanilamide to the flask. Bring the flask to volume with deionized water. Once dissolution is complete transfer reagent to a brown poly-bottle and store in the refrigerator. Write name of preparer, preparation date, reagent manufacturers, manufacturers' lot numbers in the Analytical Reagent log book. This reagent is stable for six months.

7.8 N-1-naphthylethylenediamine dihydrochloride –

N-1-naphthylethylenediamine dihydrochloride 1.0 g

Place 1.0 g N-1-naphthylethylenediamine dihydrochloride in a 1 L volumetric flask. Bring flask to volume with deionized water. Once dissolution is complete transfer reagent to a brown poly-bottle and store in refrigerator. Write name of preparer, preparation date, reagent manufacturer, manufacturer lot number in the Analytical Reagent log book. This reagent is stable for six months.

7.9 Nitrate Stock Standard, 5000 μM –

Potassium nitrate (KNO_3), primary standard grade, dried at 45°C
0.5055 g

In a 1 L volumetric flask, dissolve 0.5055 g of potassium nitrate in approximately 800 mL deionized water. Bring flask to volume with deionized water (1 mL contains 5 $\mu\text{moles N}$). Write name of preparer, preparation date, standard manufacturer, manufacturer lot number in the Analytical Standard log book. Make fresh every 4 months.

7.10 Stock Nitrite Standard –

Sodium nitrite (NaNO_2), primary standard grade, dried at 45°C

0.345 g

In a 1 L volumetric flask, dissolve 0.345 g of sodium nitrite in approximately 800 mL of deionized water. Dilute to volume with deionized water (1 mL contains 5 $\mu\text{moles N}$). Add 1 mL of chloroform as a preservative. Write name of preparer, preparation date, standard manufacturer, manufacturer lot number in the Analytical Standard log book. Make fresh every 4 months.

7.11 Secondary Nitrite Standard –

Stock Nitrite Standard 0.40 mL

In a 100 mL volumetric flask, dilute 0.40 mL of Stock Nitrite Standard to volume with deionized water to yield a concentration of 20 $\mu\text{M NO}_2^-/\text{L}$ (0.28 mg N/L). Write name of preparer, preparation date, standard manufacturer, manufacturer lot number in the Analytical Standard log book. Make fresh every 4 months.

7.12 Aquakem Cleaning Solution –

Clorox 75.0 mL

In a 100 mL volumetric flask, dilute 75.0 mL of Clorox to volume with deionized water to yield a concentration of 75% Clorox. Write name of

preparer, preparation date, reagent manufacturer, manufacturer lot number in the Analytical Reagent log book. This reagent is stable for six months.

8 SAMPLE COLLECTION, PRESERVATION, AND STORAGE

- 8.1 Water collected for NO_3+NO_2 should be filtered through a Whatman GF/F glass fiber filter (nominal pore size 0.7 μm), or equivalent.
- 8.2 Water collected for NO_3+NO_2 should be frozen at -20°C . The AutoAnalyzer vial container should be clean and sample rinsed.
- 8.3 Frozen NO_3+NO_2 samples may be stored up to 28 days. It has been shown that frozen QCS samples up to a year old still fall well within the control limits.
- 8.4 NO_3+NO_2 samples may be refrigerated at 4°C for no longer than one day.

9 QUALITY CONTROL

- 9.1 The laboratory is required to operate a formal quality control (QC) program. The minimum requirements of this program consist of an initial demonstration of laboratory capability and the continued analysis of laboratory instrument blanks and calibration standard material, analyzed as samples, as a continuing check on performance. The laboratory is required to maintain performance records that define the quality of data generated.
- 9.2 Initial Demonstration of Performance
 - 9.2.1 The initial demonstration of capability (NO_3+NO_2) – is used to characterize instrument performance (MDLs) and laboratory performance (analysis of QC samples) prior to the analyses conducted by this procedure.
 - 9.2.2 Linear Dynamic Range – LDR (Linear Calibration Range) should be established for NO_3+NO_2 using appropriate eight point calibration curve.
 - 9.2.3 Quality Control Sample (QCS/SRM) – When using this procedure, a quality control sample is required to be analyzed at the beginning and end of the run, to verify data quality and acceptable instrument performance. If the determined concentrations are not within $\pm 10\%$ of the certified values, performance of the determinative step of the method is unacceptable. The source of the problem must be identified and corrected before either proceeding with the initial determination of MDLs or continuing with analyses.
 - 9.2.4 Method Detection Limits (MDLs) – MDLs should be established for NO_3+NO_2 using a low level ambient water sample. To determine the MDL values, analyze seven replicate aliquots of water. Perform all calculations defined in the procedure (Section xx) and report the concentration values in the appropriate units. Calculate the MDL as follows:

$$\text{MDL} = s \times 3$$

Where, s = Standard Deviation of the replicate analyses.

- 9.2.5 MDLs shall be determined yearly and whenever there is a significant change in instrument response, a significant change in instrument configuration, or a new matrix is encountered.

9.3 Assessing Laboratory Performance

- 9.3.1 Laboratory Reagent Blank (LRB) – The laboratory must analyze at least one LRB with each batch of samples. The LRB consists of Nanopure water treated the same as the samples. Analyte found in LRB indicates possible reagent or laboratory environment contamination. LRB data are used to assess and correct contamination from the laboratory environment. LRB above the lowest standard requires that the source of the problem must be identified and corrected before proceeding with analyses.
- 9.3.2 Quality Control Sample (QCS)/ Standard Reference Material (SRM) – When using this procedure, a quality control sample is required to be analyzed at the beginning of the run and end of the run, to verify data quality and acceptable instrument performance. If the determined concentrations are not within $\pm 3s$ of the certified values, performance of the determinative step of the method is unacceptable. The source of the problem must be identified and corrected before either proceeding with the initial determination of MDLs or continuing with the analyses. The results of these QCS/SRM samples shall be used to determine batch acceptance.
- 9.3.3 The QCS are obtained from a source external to the laboratory and different from the source of calibration standards.
- 9.3.4 Control Charts – The Accuracy Control Chart for QCS/SRM samples is constructed from the average and standard deviation of the 20 most recent QCS/SRM measurements. The accuracy chart includes upper and lower warning levels ($WL = \pm 2s$) and upper and lower control levels ($CL = \pm 3s$). These values are derived from stated values of the QCS/SRM. The standard deviation (s) is specified relative to statistical confidence levels of 95% for WLs and 99% for CLs. Set up an accuracy chart by using percent recovery since the concentration of the QCS/SRM varies. Enter QCS/SRM results on the chart each time the sample is analyzed
- 9.3.5 Continuing Calibration Verification (CCV) – Following every 18-23 samples, one CCV of 10 μM NO_3 (0.14 mg N/L) NiRMID, 20 μM NO_3 (0.28 mg N/L) NiRHI, 200 μM NO_3 (2.8 mg N/L) NiRXH is analyzed to assess instrument performance. The CCVs are made from the same material as calibration standards (KNO_3), and are to be within $TV \pm 3s$. Failure to meet the criteria requires correcting the

problem, including reanalysis of any affected samples. If not enough sample exists, the data must be qualified if reported.

- 9.3.6 Reduction Efficiency Verification (REV) – The REVs are made from NaNO_2 , $20 \mu\text{M NO}_2$ (0.28 mg N/L) and are to be within $\text{TV} \pm 3s$ of the equivalent CCV, $20 \mu\text{M NO}_3$ (0.28 mg N/L). Failure to meet the criteria requires correcting the problem.
- 9.3.7 Reagent Blank – The Reagent Blank Control Chart for Reagent Blank samples is constructed from the average and standard deviation of the 20 most recent Reagent Blank measurements. The accuracy chart includes upper and lower warning levels ($\text{WL}=\pm 2s$) and upper and lower control levels ($\text{CL}=\pm 3s$). The standard deviation (s) is specified relative to statistical confidence levels of 95% for WLs and 99% for CLs. Enter Reagent Blank results on the chart each time the Reagent Blank is analyzed.

9.4 Assessing Analyte Recovery - % Recovery

- 9.4.1 Analyte recovery is assessed through percent recoveries of laboratory spikes of samples.
- 9.4.2 $\% \text{ Recovery} = (\text{Spiked sample concentration} - \text{Sample concentration} / \text{Concentration of spike solution}) \times 100$

9.5 Assessing Analyte Precision – Relative Percent Difference

- 9.5.1 Analyte replication is assessed through duplicate analyses of samples – Relative Percent Difference.
- 9.5.2 $\text{RPD} = (\text{Laboratory Duplicate Result 1} - \text{Laboratory Duplicate Result 2}) / [(\text{Laboratory Duplicate Result 1} + \text{Laboratory Duplicate Result 2}) / 2] \times 100$

9.6 Corrective Actions for Out of Control Data

- 9.6.1 Control limit – If one measurement exceeds Accuracy Control Chart CL, repeat the analysis immediately. If the repeat measurement is within the CL, continue analyses; if it exceeds the CL, discontinue analyses and correct the problem.
- 9.6.2 Warning limit – If two out of three successive points exceed Accuracy Control Chart WL, analyze another sample. If the next point is within WL, continue analyses; if the next point exceeds the WL, evaluate potential bias and correct the problem.
- 9.6.3 Trending – If seven successive Accuracy Control Chart measurements are on the same side of the central line, discontinue analyses and correct the problem.
- 9.6.4 When external QCS samples are out of control, correct the problem. Reanalyze the samples analyzed between the last in-control measurement and the out-of-control one.
- 9.6.5 When external CCV samples are out of control, correct the problem. Reanalyze the samples analyzed between the last in-control measurement and the out-of-control one.

9.7 General Operation - To assure optimal operation and analytical results, the Reagent Blank and CCV are tracked daily in the raw data file, copied to Reagent Blank and CCV Control Charts.

10 CALIBRATION AND STANDARDIZATION

10.1 Calibration – Daily calibration must be performed before sample analysis may begin. Eight point calibrations are used with each of the three sub-calibrations that cover the analytical range. Five working nitrate standards are used to produce the calibrators for each set of three calibration curves. The instrument performs serial dilutions of working standards to produce the eight calibrators defined for each curve. The following outlines the preparation of the working standards and the following table describes the subsequent serial dilutions the instrument performs to make each standard for each of the three calibration curves.

NO₃ Working Standards:

NiRMID

Working Standard 0.7 mg N/L (1.0 mL stock to 100 mL)

Working Standard 0.28 mg N/L (0.4 mL stock to 100 mL)

NiRHI

Working Standard 2.8 mg N/L (4 mL stock to 100 mL)

Working Standard 0.7 mg N/L (1.0 mL stock to 100 mL)

NiRXHI

Working Standard 5.6 mg N/L (8.0 mL stock to 100 mL)

Working Standard 22.4 mg N/L (32 mL stock to 100 mL)

NO₃ Calibrators:

	Working Standard mg/L N	Dilution Factor	Concentration mg/L N
NiRMID	0.28	10	0.028
	0.28	6	0.047
	0.28	5	0.056
	0.28	3	0.093
	0.28	2	0.140
	0.7	4	0.175
	0.7	3	0.233
	0.28	1	0.280
NiRHI	0.7	10	0.070
	0.7	6	0.117
	0.7	5	0.140

	0.7	3	0.233
	0.7	2	0.350
	2.8	6	0.467
	2.8	5	0.560
	0.7	1	0.700
NiRXH	5.6	10	0.560
	5.6	6	0.933
	5.6	5	1.120
	5.6	3	1.867
	5.6	2	2.800
	22.4	6	3.733
	22.4	5	4.480
	5.6	1	5.600

10.2 The instrument software prepares a standard curve for each set of calibrators. A graph plotting measured absorbance against standard concentration is presented for review and approval. If acceptance criteria are not met the entire curve can be reanalyzed or individual standards can be reanalyzed. One standard value (original or reanalyzed) for each and every standard is incorporated in the curve. The coefficient of determination (Person's r value) for the calibration curve as well as the calculated concentration of each calibrator is reviewed. The calculated value of each calibrator must be within ten percent of the expected value. The coefficient of determination (Person's r value) for the calibration curve must be greater than 0.980.

11 PROCEDURE – DAILY OPERATIONS QUALITY CONTROL

- 11.1 Turn on computer. Computer will automatically initiate Konelab software. Once software is running, turn on instrument and allow connection between instrument and computer to complete.
- 11.2 Discard any water remaining in the water reservoir from the previous analytical run. Fill the water reservoir with fresh deionized water.
- 11.3 Remove from freezer samples that will be analyzed that day. Allow samples to begin thawing. Begin daily bench sheet documentation. Remove SRM from freezer as well and allow to thaw. Also remove nitrate reductase and NADH vials from freezer.
- 11.4 Once water reservoir is full, “perform washes” – complete five wash cycles and then initiate “start-up” at main menu.
- 11.5 Gather working standards and reagents from refrigerator during startup. Assess standards and reagents. Remake anything that has exceeded the time over which it is considered stable. Nitrate reductase and NADH reagents are to be made fresh for every analytical run.
- 11.6 Once startup is complete, check that the instrument water blank of water from the reservoir has performed within acceptance limits. If any of the

- instrument functions are outside their predefined and software controlled limits, the user will be notified on the main menu page. User takes corrective action to return instrument functions to controlled limits.
- 11.7 Load reagents into reagent carousel and place into refrigerated reagent compartment.
- 11.8 Load working standards into a sample segment, identify the standards in their positions from the drop down menus at the individual segment positions, and load into instrument.
- 11.9 Select the methods to be calibrated. Three methods will be calibrated – NiRMID, NiRHI and NiRXH are the method names to be selected in the software.
- 11.10 Begin calibration – See test flow below for stepwise instrument functions for the analysis of standards and samples.
- Test Flow – Method of Analysis, Stepwise
- 55 µL NiR AtNaR to cuvette
 - 5 µL sample to cuvette with mixing
 - 15 µL NiR NADH to cuvette with mixing
 - Incubation, 600 seconds, 37°C
 - 25 µL sulfanilamide (SAN) reagent to cuvette with mixing
 - Incubation, 120 seconds, 37°C
 - 25 µL N-1-Naphthylethylenediamine dihydrochloride (NED) reagent to cuvette with mixing
 - Incubation, 120 seconds, 37°C
 - End point absorbance measurement, 540 nm
 - Side-wavelength measurement, 700 nm
 - Software processes absorbance value, side wave length value and uses calibration curve to calculate analyte concentration (mg/L N as NO₂)
 - User is notified if any measured values used to calculate final concentration are outside preset limits. If so, analyst has options to accept results, rerun the sample or rerun the sample diluted to a user or software specified factor.
 - User is notified of each side wave length value. Side wave length >0.002 absorbance units indicates a scratched cuvette or turbid sample. If the side wave length value exceeds 0.002 absorbance units, the analyst specifies that the sample is reanalyzed. If the side wave length of the reanalyzed sample is <0.002 absorbance units, the reanalyzed result is accepted. If the same concentration and side wave length >0.002 absorbance units is again obtained, the results are accepted.
- 11.11 Organize samples, reagent blanks, check standards and all quality control samples while instrument performs calibrations.
- 11.12 As calibration curves are produced by the instrument, review them for acceptability. The instrument software prepares a standard curve for each set of calibrators. A graph plotting measured absorbance against standard concentration is presented for review and approval. If acceptance criteria are not met, either the entire curve shall be reanalyzed or individual standards shall be reanalyzed,

depending on the violation. One standard value (original or reanalyzed) for each and every calibrator is incorporated in the curve.

- 11.13 Once calibration curves are accepted, samples are loaded into the sample segments and loaded into the instrument for analysis. After the Reagent Blank, the first samples analyzed should be an ICV (initial calibration verification) samples. There should be one sample for each calibration curve, of a concentration close to the middle of each range. The following are the usual ICV samples for each curve: 0.14 mg N/L NiRMID, 0.28 mg N/L NiRHI and 2.8 mg N/L NiRXH. Secondary Nitrite Standard (REV) (0.28 mg N/L) should be analyzed and compared with 0.28 mg N/L ICV to determine reduction efficiency.
- 11.14 Samples are loaded into the segments and analyzed. CCV (Continuing Calibration Verification) samples (one for each of the three calibration ranges) follow every 18-23 samples. Standard Reference Material (SRM) samples, as well as Laboratory Reagent Blanks (LRB) are scattered throughout the analytical batch. Throughout the analytical batch, samples are chosen as laboratory duplicates and laboratory spikes to assess analyte precision and analyte recovery, respectively. The total number of duplicates and spikes performed will be equal or greater to ten percent of the total number of samples in the analytical batch.
- 11.15 As sample analysis is complete, results must be reviewed and accepted manually. If results fall outside acceptance limits, the sample should be reanalyzed. If sample result exceeds the highest standard of the calibration range it was run within, the samples can be automatically diluted by the instrument and reanalyzed. If the result is such that it will fall within a higher calibration range, it should be reanalyzed in that range. If the result is such that it will fall within a lower calibration range, it should be reanalyzed within that range. If the result falls below the lowest standard of the lowest calibration range, the result should be discarded and the sample should be analyzed via cadmium reduction method.
- 11.16 Upon completion of all analysis, results are saved to a daily report file. The file is named by the run date. The daily report file for analytical batch of January 1, 2005 would be named 010105. The file is converted to Microsoft Excel for data work up. Remaining samples are discarded.
- 11.17 All reagents are removed from the reagent chamber and returned to the refrigerator. Reagents that have exceeded their stability period are discarded.
- 11.18 Aquakem Cleaning Solution is inserted into the instrument and shut down procedures are initiated. Daily files are cleared from the instrument software, the software is exited and the instrument is shut down. The computer is shut down.
- 11.19 The waste is flushed down the drain with copious amounts of tap water. The waste cuvette box is moved to the fume hood. The incubator cover plate is removed. The incubator is wiped clean. The cover is cleaned and returned to its original position.

12 DATA ANALYSIS AND CALCULATIONS

- 12.1 Upon completion of all analysis, results are saved to a daily report file. The file is named by the run date. The daily report file for analytical batch of January 1, 2005 would be named 010105. The file is converted to Microsoft

Excel for data work up. The instrument software has calculated final sample concentration from the designated standard curve, correcting each concentration for associated side wave length and also for any user or instrument specified dilution. Dilution by the instrument is noted by software as analysis ensues and, also, documented in the Excel data report file. The analyst examines each row of data. Results are eliminated that are outside the limits of the calibration range, or have an unrepeated side wave length measurement greater than 0.002 absorbance units.

13 METHOD PERFORMANCE

- 13.1 On 13 separate dates from January through November 2008, 198 replicate analyses of SPEX® Corporation QC 6-42 NUT 1 were performed on NiRMID. This produced a mean value of 0.198 mg NO₃+NO₂ N/L, SD 0.028, Relative Percent Difference of 1.7% from the expected value of 0.202 ± 10%. This is a mean recovery of 98%.
- 13.2 For some estuarine samples analyzed on NiRMID in 2008, the mean difference in concentration between 27 duplicates analyzed on 13 separate dates was 0.0020 mg NO₃+NO₂ N/L. The standard deviation of the difference between duplicates was 0.0086 NO₃+NO₂ N/L.
- 13.3 For some estuarine samples analyzed on NiRHI in 2008, the mean difference in concentration between 19 duplicates analyzed on 13 separate dates was 0.0007 mg NO₃+NO₂ N/L. The standard deviation of the difference between duplicates was 0.0073 NO₃+NO₂ N/L.
- 13.4 For some estuarine samples analyzed on NiRXHI in 2008, the mean difference in concentration between 15 duplicates analyzed on 13 separate dates was 0.002 mg NO₃+NO₂ N/L. The standard deviation of the difference between duplicates was 0.011 NO₃+NO₂ N/L.

14 REFERENCES

- 14.1 Campbell, et al. (2006). Nitrate reductase for nitrate analysis in water. Environ Chem Letters 4:69. <http://www.nitrate.com/ECL2006.pdf>
- 14.2 Frank, J. M., C.F. Zimmermann and C. W. Keefe (2006). Comparison of results from Konelab Aquakem 250 and existing nutrient analyzers. UMCES CBL Nutrient Analytical Services Laboratory, Dec. 2006.
- 14.3 Patton, et al. (2002). Corn leaf nitrate reductase – a nontoxic alternative to cadmium for photometric nitrate determinations in water samples by air-segmented continuous-flow analysis, Environ. Sci Tech. 2002, 36, 729-735. <http://www.nitrate.com/pattonetal2002.pdf>
- 14.4 <http://www.nitrate.com/nar-nam1.htm>

Determination of Dissolved Inorganic Ammonium (NH₄) in Fresh/Estuarine/Coastal Waters

1. SCOPE and APPLICATION

- 1.1 Determination of ammonium is by the Bertholet Reaction in which a blue-colored compound, similar to indophenol, forms when a solution of ammonium salt is added to sodium phenoxide. The method is used to analyze all ranges of salinity.
- 1.2 A Method Detection Limit (MDL) of 0.003 mg NH₄-N/L was determined as three times the standard deviation of seven low level replicates.
- 1.3 The Quantitation Limit for NH₄ was set at 0.010 mg NH₄-N/L, or ten times the standard deviation of the MDL calculation.
- 1.4 The method is suitable for NH₄ concentrations 0.003 to 1.68 mg NH₄-N/L.
- 1.5 This procedure should be used by analysts experienced in the theory and application of aqueous inorganic analysis. Three months experience with an experienced analyst, certified in the analysis of ammonium in aqueous samples is required.
- 1.6 This method can be used for all programs that require analysis of dissolved ammonium.
- 1.7 This procedure conforms to EPA Method 350.2 (1979).

2. SUMMARY

2.1 Filtered samples are complexed with sodium potassium tartrate and sodium citrate. The complexed sample reacts with alkaline phenol and hypochlorite, catalyzed by sodium nitroprusside, yielding an intense blue color suitable for photometric measurement.

3. DEFINITIONS

- 3.1 Acceptance Criteria – Specified limits placed on characteristics of an item, process, or service defined in a requirement document. (ASQC)
- 3.2 Accuracy – The degree of agreement between an observed value and an accepted reference value. Accuracy includes a combination of random error (precision) and systematic error (bias) components which are due to sampling and analytical operations; a data quality indicator. (QAMS)
- 3.3 Aliquot – A discrete, measured, representative portion of a sample taken for analysis. (EPA QAD Glossary)
- 3.4 Analytical Range – 0.010 to 1.68 mg NH₄-N/L. The overall analytical range is comprised of two distinct concentration ranges. A separate calibration is performed for each range. These ranges include 0.010 to

0.168 mg NH₄-N/L, and 0.168 to 1.68 mg NH₄-N/L. Two sub-ranges are utilized so that samples can be analyzed on the most appropriate scale possible.

- 3.5 Batch – Environmental samples, which are prepared and /or analyzed together with the same process and personnel, using the same lot(s) of reagents. A **preparation batch** is composed of one to 200 environmental samples of the same matrix, meeting the above mentioned criteria and with a maximum time between the start of processing of the first and last sample in the batch to be 8 hours. An **analytical batch** is composed of prepared environmental samples (extracts, digestates, concentrates) and/or those samples not requiring preparation, which are analyzed together as a group using the same calibration curve or factor. An analytical batch can include samples originating from various environmental matrices and can exceed 20 samples. (NELAC/EPA)
- 3.6 Blank- A sample that has not been exposed to the analyzed sample stream in order to monitor contamination during sampling, transport, storage or analysis. The blank is subjected to the usual analytical and measurement process to establish a zero baseline or background value and is sometimes used to adjust or correct routine analytical results. (ASQC)
- 3.7 Calibrate- To determine, by measurement or comparison with a standard, the correct value of each scale reading on a device. The levels of the applied calibration standard should bracket the range of planned or expected sample measurements. (NELAC)
- 3.8 Calibration – The set of operations which establish, under specified conditions, the relationship between values indicated by a measuring device. The levels of the applied calibration standard should bracket the range of planned or expected sample measurements. (NELAC)
- 3.9 Calibration Blank – A volume of reagent water fortified with the same matrix as the calibration standards, without analyte added.
- 3.10 Calibration Curve – The graphical relationship between known values, such as concentrations, or a series of calibration standards and their analytical response. (NELAC)
- 3.11 Calibration Method – A defined technical procedure for performing a calibration. (NELAC)
- 3.12 Calibration Standard – A substance or reference material used to calibrate an instrument. (QAMS)
- 3.12.1 Initial Calibration Standard (STD) – A series of standard solutions used to initially establish instrument calibration responses and develop calibration curves for individual target analytes.
- 3.12.2 Initial Calibration Verification (ICV) – An individual standard, distinct from the Initial Calibration Standards (STD), analyzed initially, prior to any sample analysis,

- which verifies acceptability of the calibration curve or previously established calibration curve.
- 3.12.3 Continuing Calibration Verification (CCV) – An individual standard, distinct from the Initial Calibration Standards (STD), analyzed after every 15-20 field sample analyses.
- 3.13 Certified Reference Material – A reference material one or more of whose property values are certified by a technically valid procedure, accompanied by or traceable to a certificate or other documentation which is issued by a certifying body. (ISO 17025)
- 3.14 Corrective Action – Action taken to eliminate the causes of an existing nonconformity, defect or other undesirable situation in order to prevent recurrence. (ISO 8402)
- 3.15 Deficiency – An unauthorized deviation from acceptable procedures or practices. (ASQC)
- 3.16 Demonstration of Capability – A procedure to establish the ability of the analyst to generate acceptable accuracy. (NELAC)
- 3.17 Detection Limit – The lowest concentration or amount of the target analyte that can be determined to be different from zero by a single measurement at a stated degree of confidence.
- 3.18 Duplicate Analysis – The analyses of measurements of the variable of interest performed identically on two sub samples (aliquots) of the same sample. The results from duplicate analyses are used to evaluate analytical or measurement precision but not the precision of sampling, preservation or storage internal to the laboratory. (EPA-QAD)
- 3.19 External Standard (ES) – A pure analyte (Sodium Nitrite (NaNO_2)) that is measured in an experiment separate from the experiment used to measure the analyte(s) in the sample. The signal observed for a known quantity of the pure external standard is used to calibrate the instrument response for the corresponding analyte(s). The instrument response is used to calculate the concentrations of the analyte(s) in the unknown sample.
- 3.20 Field Duplicates (FD1 and FD2) – Two separate samples collected at the same time and place under identical circumstances and treated exactly the same throughout field and laboratory procedures. Analyses of FD1 and FD2 provide a measure of the precision associated with sample collection, preservation and storage, as well as with laboratory procedures.
- 3.21 Holding time – The maximum time that samples may be held prior to analysis and still be considered valid. (40 CFR Part 136) The time elapsed from the time of sampling to the time of extraction or analysis, as appropriate.
- 3.22 Laboratory Duplicates (LD1 and LD2) – Two aliquots of the same sample taken in the laboratory and analyzed separately with identical procedures. Analyses of LD1 and LD2 indicate precision associated with laboratory procedures, but not with sample collection, preservation, or storage procedures.

- 3.23 Laboratory Reagent Blank (LRB) – A blank matrix (i.e., DI water) that is treated exactly as a sample including exposure to all glassware, equipment, solvents, and reagents that are used with other samples. The LRB is used to determine if method analytes or other interferences are present in the laboratory environment, the reagents, or the instrument.
- 3.24 Laboratory Control Sample (LCS) – A sample matrix, free from the analytes of interest, spiked with verified known amounts of analytes from a source independent of the calibration standard or a material containing known and verified amounts of analytes. The LCS is generally used to establish intra-laboratory or analyst-specific precision and bias or to assess the performance of all or a portion of the measurement system. (NELAC)
- 3.25 Limit of Detection (LOD) – The lowest concentration level that can be determined by a single analysis and with a defined level of confidence to be statistically different from a blank. (ACS)
- 3.26 Limit of Quantitation (LOQ) – The minimum levels, concentrations, or quantities of a target variable (target analyte) that can be reported with a specified degree of confidence. The LOQ is set at 3 to 10 times the LOD, depending on the degree of confidence desired.
- 3.27 Linear Dynamic Range (LDR) – The absolute quantity over which the instrument response to an analyte is linear. This specification is also referred to as the Linear Calibration Range (LCR).
- 3.28 Material Safety Data Sheets (MSDS) – Written information provided by vendors concerning a chemical's toxicity, health hazards, physical properties, fire, and reactivity data including storage, spill, and handling precautions.
- 3.29 May – Denotes permitted action, but not required action. (NELAC)
- 3.30 Method Detection Limit (MDL) – The minimum concentration of an analyte that can be identified, measured, and reported with 99% confidence that the analyte concentration is greater than zero (Standard Methods).
- 3.31 Must – Denotes a requirement that must be met. (Random House College Dictionary)
- 3.32 Photometer – measures the absorbance of the solution in the cell in a multicell cuvette. Light passes from the lamp through the condensing lenses to the interference filter. The plane surface of the first condensing lens is coated with a material which reflects heat and infrared light. The filters are mounted on a filter wheel. There are 15 positions for filters. Each filter corresponds to a wavelength of interest. The 630 nm filter is specified by the test definition for ammonium. After passing through the filter the light is converted into a stream of light pulses by a chopper. Then the light is directed via a quartz fiber through a focusing lens and a slit to the beam divider. The

beam divider divides the light into two parts. A specified portion is reflected to the reference detector, which monitors the light level fluctuations. The remaining major portion of the light beam goes through the liquid in the cell to the signal detector, which measures the amount of light absorbed.

- 3.33 Precision – The degree to which a set of observations or measurements of the same property, obtained under similar conditions, conform to themselves; a data quality indicator. Precision is usually expressed as standard deviation, variance or range, in either absolute or relative terms. (NELAC)
- 3.34 Preservation – Refrigeration, freezing, and/or reagents added at the time of sample collection (or later) to maintain the chemical and or biological integrity of the sample.
- 3.35 Quality Control Sample (QCS) – A sample of analyte of known and certified concentration. The QCS is obtained from a source external to the laboratory and different from the source of calibration standards. It is used to check laboratory performance with externally prepared test materials.
- 3.36 Run Cycle – Typically a day of operation – the entire analytical sequence from sampling the first standard to the last sample of the day.
- 3.37 Sample Segment – Bar-coded metal tray that holds up to fourteen four milliliter auto analyzer vials containing samples or standards. The user identifies each vial in the operating software.
- 3.38 Sample Segment Holder – An automated temperature controlled carousel that contains up to six sample segments. This carousel spins in clockwise or counterclockwise manner to move the sample segments into position for analysis. This carousel format allows for continuous processing.
- 3.39 Sensitivity – The capability of a test method or instrument to discriminate between measurement responses representing different levels (concentrations) of a variable of interest.
- 3.40 Shall – Denotes a requirement that is mandatory whenever the criterion for conformance with the specification requires that there be no deviation. (ANSI)
- 3.41 Should – Denotes a guideline or recommendation whenever noncompliance with the specification is permissible. (ANSI)
- 3.42 Standard Reference Material (SRM) – Material which has been certified for specific analytes by a variety of analytical techniques and/or by numerous laboratories using similar analytical techniques. These may consist of pure chemicals, buffers, or compositional standards. The materials are used as an indication of the accuracy of a specific analytical technique.
- 3.43 Test Definition – A photometric test consisting of a user defined testing sequence, reagent additions, calibration standards, incubations and absorption results.

3.44 Test Flow – Functions to define the parameter for reagent and sample dispensing, dilution, incubation and measurement.

4 INTERFERENCES

- 4.1 Suspended matter in the sample will scatter light as it passes through the cuvette to the detector. High blank responses will result. The identified sample will be reanalyzed.
- 4.2 Blemishes in the cuvette, as result of the manufacturing process, will result in high blank responses. The identified sample will be reanalyzed.
- 4.3 Seawater contains calcium and magnesium ions in sufficient concentrations to cause precipitation during analysis, reducing color production. Adding sodium potassium tartrate and sodium citrate reduces the interference.
- 4.4 Eliminate any added acidity in samples because intensity of measured color is pH-dependent.

5 SAFETY

- 5.1 Safety precautions must be taken when handling reagents, samples and equipment in the laboratory. Protective clothing including lab coats, safety glasses and enclosed shoes should be worn. In certain situations, it will be necessary to also use gloves and/or a face shield. If solutions come in contact with eyes, flush with water continuously for 15 minutes. If solutions come in contact with skin, wash thoroughly with soap and water. Contact Solomons Rescue Squad (911) if emergency treatment is needed and also inform the CBL Business Manager of the incident. Contact the CBL Business Manager if additional treatment is required.
- 5.2 The toxicity or carcinogenicity of each reagent used in this procedure may not have been fully established. Each chemical should be regarded as a potential health hazard and exposure should be as low as reasonably achievable. Cautions are included for known hazardous materials and procedures.
- 5.3 Do not wear jewelry when troubleshooting electrical components. Even low voltage points are dangerous and can injure if allowed to short circuit.
- 5.4 The following hazard classifications are listed for the chemicals used in this procedure. Detailed information is provided on Material Safety Data Sheets (MSDS).

Chemical	Health	Flammability	Reactivity	Contact	Storage
Sodium potassium tartrate	0	1	0	0	Green
Sodium citrate	1	1	0	1	Green
Sulfuric acid	4	0	2	4	White
Phenol	3	2	1	4	White Stripe
Sodium hydroxide	3	0	2	4	White Stripe

Sodium nitroprusside	3	0	0	1	Blue
Sodium hypochlorite (Clorox)	3	0	2	4	White
Ammonium sulfate	1	0	1	2	Green
Chloroform	3	1	1	3	Blue

On a scale of 0 to 4 the substance is rated on four hazard categories: health, flammability, reactivity, and contact. (0 is non-hazardous and 4 is extremely hazardous)

STORAGE

Red – Flammability Hazard: Store in a flammable liquid storage area.

Blue – Health Hazard: Store in a secure poison area.

Yellow – Reactivity Hazard: Keep separate from flammable and combustible materials.

White – Contact Hazard: Store in a corrosion-proof area.

Green – Use general chemical storage (On older labels, this category was orange).

Striped – Incompatible materials of the same color class have striped labels. These products should not be stored adjacent to substances with the same color label. Proper storage must be individually determined.

6 EQUIPMENT AND SUPPLIES

6.1 Aquakem 250 multi-wavelength automated discrete photometric analyzer.

Aquakem 250 control software operates on a computer running Microsoft Windows NT or XP operating system.

6.2 Freezer, capable of maintaining $-20 \pm 5^\circ \text{C}$.

6.3 Lab ware – All reusable lab ware (glass, Teflon, plastic, etc) should be sufficiently clean for the task objectives. This laboratory cleans all lab ware related to this method with a 10% HCl (v/v) acid rinse.

7 REAGENTS AND STANDARDS

7.1 Purity of Water – Unless otherwise indicated, references to water shall be understood to mean reagent water conforming to Specification D 1193, Type I. Freshly prepared water should be used for making the standards intended for calibration. The detection limits of this method will be limited by the purity of the water and reagents used to make the standards.

7.2 Purity of Reagents – Reagent grade chemicals shall be used in all tests. Unless otherwise indicated, it is intended that all reagents shall conform to specifications of the Committee on Analytical Reagents of the American Chemical Society, where such specifications are available. Other grades may be used, provided it is first ascertained that the reagent is of sufficiently high purity to permit its use without compromising the accuracy of the determination.

7.3 Complexing reagent

Sodium potassium tartrate ($\text{KNaC}_4\text{H}_4\text{O}_6 \cdot 4\text{H}_2\text{O}$)	3.9 g
Sodium citrate ($\text{C}_6\text{H}_8\text{N}_2 \text{O}_2\text{S}$)	2.8 g
Sulfuric acid (H_2SO_4), concentrated (sp. gr. 1.84)	as required

In a 150 mL beaker, dissolve 3.9 g sodium potassium tartrate and 2.8 g sodium citrate in approximately 95 ml deionized water. Adjust the pH of the solution to 5.0 using concentrated sulfuric acid. Transfer solution to a 100 mL volumetric flask and bring to volume. Write name of preparer, preparation date, reagent manufacturer, manufacturer's lot number in the Analytical Reagent log book. Store flask in dark at room temperature. Reagent is stable for two weeks. Discard if precipitate forms.

7.4 Alkaline phenol solution

Phenol (C ₆ H ₅ OH), 88%	23.6 mL
--	---------

Sodium hydroxide (NaOH), 50% (w/w)	18.0 g
------------------------------------	--------

In a 250 mL volumetric flask, slowly add 23.6 mL of 88% phenol to approximately 150 mL deionized water. While in an ice bath, add exactly 18 g of 50% (w/w) sodium hydroxide to the phenol/water solution. Bring flask to volume with deionized water. Store flask in light resistant container in refrigerator. Write name of preparer, preparation date, reagent manufacturer, manufacturer's lot number in the Analytical Reagent log book. Reagent is stable for two weeks.

WARNING: Phenol is extremely dangerous and should be handled accordingly. Prepare in an operating fume hood wearing protective gloves.

7.5 Sodium hypochlorite, 1% –

Sodium hypochlorite (Clorox Ultra – 6%)	44 mL
---	-------

Deionized water	200 mL
-----------------	--------

In a 250 mL flask, dilute 44 mL of commercially available bleach containing 6% sodium hypochlorite with 200 mL deionized water. Write name of preparer, preparation date, manufacturer, date Clorox purchased in the Analytical Reagent log book. Reagent is stable for two days.

7.6 Sodium nitroprusside (Sodium nitroferricyanide), 0.05% –

Sodium nitroprusside	0.5 g
----------------------	-------

Deionized water	up to 1000 mL
-----------------	---------------

In a 1000 mL flask, dissolve 0.5 g of sodium nitroprusside in 900 mL deionized water. Dilute to 1000 mL with deionized water. Write name of preparer, preparation date, reagent manufacturer, manufacturer lot number in the Analytical Reagent log book. Reagent is stable for one year.

7.7 Ammonium Stock Standard, 1,500 μM –

Ammonium Sulfate [(NH ₄) ₂ SO ₄], primary standard grade, dried at 45°C	0.100 g
--	---------

Deionized water	up to 1000 mL
-----------------	---------------

In a 1000 mL volumetric flask, dissolve 0.100 g of ammonium sulfate in ~800 mL of deionized water. Dilute to 1000 mL with deionized water (1 mL contains 1.5 μmoles N). Add 1 mL of chloroform as a preservative. Write name of preparer, preparation date, standard manufacturer,

manufacturer lot number in the Analytical Standard log book. Make fresh every 4 months.

7.8 Working Regular Ammonium Standard –

Stock Ammonium Standard	0.80 mL
Deionized water	up to 100 mL

In a volumetric flask, dilute 0.80 mL of Stock Ammonium Standard to 100 mL with deionized water to yield a concentration of 12 μM $\text{NH}_4\text{-N/L}$ (0.168 mg N/L). Write name of preparer, preparation date, Ammonium Stock Standard preparation date in the Analytical Standard log book. Make fresh every month.

7.9 Working High Ammonium Standard –

Stock Ammonium Standard	8.00 mL
Deionized water	up to 100 mL

In a volumetric flask, dilute 8.00 mL of Stock Ammonium Standard to 100 mL with deionized water to yield a concentration of 120 μM $\text{NH}_4\text{-N/L}$ (1.68 mg N/L). Write name of preparer, preparation date, Ammonium Stock Standard preparation date in the Analytical Standard log book. Make fresh every month.

7.10 Aquakem Cleaning Solution –

Clorox	75.0 mL
--------	---------

In a 100 mL volumetric flask, dilute 75.0 mL of Clorox to volume with deionized water to yield a concentration of 75% Clorox. Write name of preparer, preparation date, reagent manufacturer, manufacturer lot number in the Analytical Reagent log book. Reagent is stable for six months.

8 SAMPLE COLLECTION, PRESERVATION, AND STORAGE

8.1 Water collected for ammonium should be filtered through a Whatman GF/F glass fiber filter (nominal pore size 0.7 μm), or equivalent.

8.2 Water collected for ammonium should be measured for salinity.

8.3 Water collected for ammonium should be frozen at -20°C . The AutoAnalyzer vial container should be clean and sample rinsed.

8.4 Frozen ammonium samples may be stored up to 28 days. It has been shown that frozen QCS samples up to a year old still fall well within the control limits.

8.5 Ammonium samples may be refrigerated at 4°C for no longer than one day.

9 QUALITY CONTROL

9.1 The laboratory is required to operate a formal quality control (QC) program. The minimum requirements of this program consist of an initial demonstration of laboratory capability and the continued analysis of laboratory instrument blanks and calibration standard material, analyzed as samples, as a continuing check on performance. The laboratory is required to maintain performance records that define the quality of data generated.

9.2 Initial Demonstration of Performance

- 9.2.1 The initial demonstration of capability (nitrite) – is used to characterize instrument performance (MDLs) and laboratory performance (analysis of QC samples) prior to the analyses conducted by this procedure.
- 9.2.2 Linear Dynamic Range – LDR (Linear Calibration Range) should be established for ammonium using appropriate five point calibration curve.
- 9.2.3 Quality Control Sample (QCS/SRM) – When using this procedure, a quality control sample is required to be analyzed at the beginning and end of the run, to verify data quality and acceptable instrument performance. If the determined concentrations are not within $\pm 10\%$ of the certified values, performance of the determinative step of the method is unacceptable. The source of the problem must be identified and corrected before either proceeding with the initial determination of MDLs or continuing with analyses.
- 9.2.4 Method Detection Limits (MDLs) – MDLs should be established for ammonium using a low level ambient water sample. To determine the MDL values, analyze seven replicate aliquots of water. Perform all calculations defined in the procedure (Section 12) and report the concentration values in the appropriate units. Calculate the MDL as follows:

$$\text{MDL} = s \times 3$$

Where, s = Standard Deviation of the replicate analyses.

- 9.2.5 MDLs shall be determined yearly and whenever there is a significant change in instrument response, a significant change in instrument configuration, or a new matrix is encountered.

9.3 Assessing Laboratory Performance

- 9.3.1 Laboratory Reagent Blank (LRB) – The laboratory must analyze at least one LRB with each batch of samples. The LRB consists of Nanopure water treated the same as the samples. Analyte found in LRB indicates possible reagent or laboratory environment contamination. LRB data are used to assess and correct contamination from the laboratory environment. LRB above the lowest standard

requires that the source of the problem must be identified and corrected before proceeding with analyses.

- 9.3.2 Quality Control Sample (QCS)/ Standard Reference Material (SRM) – When using this procedure, a quality control sample is required to be analyzed at the beginning of the run and end of the run, to verify data quality and acceptable instrument performance. If the determined concentrations are not within $\pm 3s$ of the certified values, performance of the determinative step of the method is unacceptable. The source of the problem must be identified and corrected before either proceeding with the initial determination of MDLs or continuing with the analyses. The results of these QCS/SRM samples shall be used to determine batch acceptance.
- 9.3.3 The QCS are obtained from a source external to the laboratory and different from the source of calibration standards.
- 9.3.4 Control Charts – The Accuracy Control Chart for QCS/SRM samples is constructed from the average and standard deviation of the 20 most recent QCS/SRM measurements. The accuracy chart includes upper and lower warning levels ($WL=\pm 2s$) and upper and lower control levels ($CL=\pm 3s$). These values are derived from stated values of the QCS/SRM. The standard deviation (s) is specified relative to statistical confidence levels of 95% for WLs and 99% for CLs. Set up an accuracy chart by using percent recovery since the concentration of the QCS/SRM varies. Enter QCS/SRM results on the chart each time the sample is analyzed
- 9.3.5 Continuing Calibration Verification (CCV) – Following every 18-23 samples, one CCV of 6.0 μM $\text{NH}_4\text{-N/L}$ (0.126 mg N/L) Regular NH_4 , 60 μM $\text{NH}_4\text{-N/L}$ (1.26 mg N/L) NH_4HIGH , is analyzed to assess instrument performance. The CCVs are made from the same material as calibration standards [$(\text{NH}_4)_2\text{SO}_4$], and are to be within $\text{TV} \pm 3s$. Failure to meet the criteria requires correcting the problem, including reanalysis of any affected samples. If not enough sample exists, the data must be qualified if reported.
- 9.3.6 Reagent Blank – The Reagent Blank Control Chart for Reagent Blank samples is constructed from the average and standard deviation of the 20 most recent Reagent Blank measurements. The accuracy chart includes upper and lower warning levels ($WL=\pm 2s$) and upper and lower control levels ($CL=\pm 3s$). The standard deviation (s) is specified relative to statistical confidence levels of 95% for WLs and 99% for CLs. Enter Reagent Blank results on the chart each time the Reagent Blank is analyzed.

9.4 Assessing Analyte Recovery - % Recovery

- 9.4.1 Analyte recovery is assessed through percent recoveries of laboratory spikes of samples.
- 9.4.2 % Recovery = $(\text{Spiked sample concentration} - \text{Sample concentration} / \text{Concentration of spike solution}) \times 100$

9.5 Assessing Analyte Precision – Relative Percent Difference

- 9.5.1 Analyte replication is assessed through duplicate analyses of samples – Relative Percent Difference.
- 9.5.2 $RPD = \frac{\text{Laboratory Duplicate Result 1} - \text{Laboratory Duplicate Result 2}}{[\text{Laboratory Duplicate Result 1} + \text{Laboratory Duplicate Result 2}]/2} \times 100$

9.6 Corrective Actions for Out of Control Data

- 9.6.1 Control limit – If one measurement exceeds Accuracy Control Chart CL, repeat the analysis immediately. If the repeat measurement is within the CL, continue analyses; if it exceeds the CL, discontinue analyses and correct the problem.
- 9.6.2 Warning limit – If two out of three successive points exceed Accuracy Control Chart WL, analyze another sample. If the next point is within WL, continue analyses; if the next point exceeds the WL, evaluate potential bias and correct the problem.
- 9.6.3 Trending – If seven successive Accuracy Control Chart measurements are on the same side of the central line, discontinue analyses and correct the problem.
- 9.6.4 When external QCS samples are out of control, correct the problem. Reanalyze the samples analyzed between the last in-control measurement and the out-of-control one.
- 9.6.5 When external CCV samples are out of control, correct the problem. Reanalyze the samples analyzed between the last in-control measurement and the out-of-control one.

- 9.7 General Operation - To assure optimal operation and analytical results, the Reagent Blank and CCV are tracked daily in the raw data file, copied to Reagent Blank and CCV Control Charts.

10 CALIBRATION AND STANDARDIZATION

- 10.1 Calibration – Daily calibration must be performed before sample analysis may begin. Five point calibrations are used with each of the two sub-calibrations that cover the analytical range. Two working nitrite standards are used to produce the calibrators for each set of two calibration curves. The instrument performs serial dilutions of working standards to produce the five calibrators defined for each curve. The following outlines the preparation of the working standards and the following table describes the subsequent serial dilutions the instrument performs to make each standard for each of the two calibration curves.

Ammonium Working Standards:

Regular NH₄ (NH₄CBL₂)

Working Standard	0.168 mg N/L	(0.8 mL stock standard to 100 mL)
Working CCV	0.126 mg N/L	(0.6 mL stock standard to 100 mL)

NH4HIGH

Working Standard 1.68 mg N/L (8.0 mL stock standard to 100 mL)

Working CCV 1.26 mg N/L (6.0 mL stock standard to 100 mL)

Nitrite Calibrators:

Test Name	Working Standard	Dilution Factor	Concentration mg N/L
NH4CBL2	0.168 mg N/L	1+9	0.0168
	0.168 mg N/L	1+4	0.0336
	0.168 mg N/L	1+2	0.056
	0.168 mg N/L	1+1	0.084
	0.168 mg N/L	1+0	0.168
NH4HIGH	1.68 mg N/L	1+9	0.168
	1.68 mg N/L	1+6	0.24
	1.68 mg N/L	1+3	0.42
	1.68 mg N/L	1+2	0.56
	1.68 mg N/L	1+1	0.84
	1.68 mg N/L	1+0	1.68

10.2 The instrument software prepares a standard curve for each set of calibrators. A graph plotting measured absorbance against standard concentration is presented for review and approval. If acceptance criteria are not met the entire curve can be reanalyzed or individual standards can be reanalyzed. One standard value (original or reanalyzed) for each and every standard is incorporated in the curve. The coefficient of determination (Person's r value) for the calibration curve as well as the calculated concentration of each calibrator is reviewed. The calculated value of each calibrator must be within ten percent of the expected value. The coefficient of determination (Person's r value) for the calibration curve must be greater than 0.980.

11 PROCEDURE – DAILY OPERATIONS QUALITY CONTROL

- 11.1 Turn on computer. Computer will automatically initiate Konelab software. Once software is running, turn on instrument and allow connection between instrument and computer to complete.
- 11.2 Discard any water remaining in the water reservoir from the previous analytical run. Fill the water reservoir with fresh deionized water.
- 11.3 Remove samples from freezer that will be analyzed that day. Allow samples to begin thawing. Begin daily bench sheet documentation.
- 11.4 Once water reservoir is full, "perform washes" – complete five wash cycles and then initiate "start-up" at main menu.

- 11.5 Gather working standards and reagents from refrigerator or dark cabinet during startup. Assess standards and reagents. Remake anything that has exceeded the time over which it is considered stable.
- 11.6 Once startup is complete, check that the instrument water blank of water from the reservoir has performed within acceptance limits. If any of the instrument functions are outside their predefined and software controlled limits, the user will be notified on the main menu page. User takes corrective action to return instrument functions to controlled limits.
- 11.7 Load reagents in specified position in reagent carousel and place in refrigerated reagent compartment.
- 11.8 Load working standards in a sample segment, identify the standards in their positions from the drop down menus at the individual segment positions, and load into instrument.
- 11.9 Select the methods to be calibrated. Two methods will be calibrated – NH4CBL2, and NH4HIGH are the method names to be selected in the software.
- 11.10 Begin calibration – See test flow below for stepwise instrument functions for the analysis of standards and samples.
- Test Flow – Method of Analysis, Stepwise
- 100 μ L sample to cuvette with mixing
 - 55 μ L Complexing Reagent to cuvette with mixing
 - 33 μ L Alkaline Phenol Reagent to cuvette with mixing
 - Blank response measurement at 630 nm
 - 26 μ L Sodium Hypochlorite Reagent to cuvette with mixing
 - 33 μ L Sodium Nitroprusside Reagent to cuvette with mixing
 - Incubation, 420 seconds, 37°C
 - End point absorbance measurement, 630 nm
 - Software processes absorbance value, blank response value and uses calibration curve to calculate analyte concentration (mg/L N as NH₄)
 - User is notified if any measured values used to calculate final concentration are outside preset limits. If so, analyst has options to accept result, rerun the sample or rerun the sample diluted to a user or software specified factor.
 - User is notified of each blank response value. Blank response >0.005 absorbance units indicates a scratched cuvette or turbid sample. If the blank response value exceeds 0.005 absorbance units, the analyst specifies that the sample is reanalyzed. If the blank response value of the reanalyzed sample is <0.005 absorbance units, the reanalyzed result is accepted. If the same concentration and blank response value >0.005 absorbance units is again obtained, the results are accepted.
- 11.11 Organize samples, reagent blanks, check standards and all quality control samples while instrument performs calibrations.
- 11.12 As calibration curves are produced by the instrument, review them for acceptability. The instrument software prepares a standard curve for each set of calibrators. A graph plotting measured absorbance against standard concentration is presented for review and approval. If acceptance criteria are not met, either the entire curve shall be reanalyzed or individual standards shall be reanalyzed,

- depending on the violation. One standard value (original or reanalyzed) for each and every calibrator is incorporated in the curve.
- 11.13 Once calibration curves are accepted, samples are loaded into the sample segments and loaded into the instrument for analysis. After the Reagent Blank, the first sample analyzed should be an ICV (initial calibration verification) sample. There should be one ICV sample for each calibration curve, of a concentration close to the middle of each range. The following are the usual ICV samples for each curve: 0.126 mg N/L for NH₄CBL2 and 1.26 mg N/L for NH₄HIGH.
- 11.14 Samples are loaded into the segments and analyzed. CCV (Continuing Calibration Verification) samples (one for each of the three calibration ranges) follow every 18-23 samples. Standard Reference Material (SRM) samples, as well as Laboratory Reagent Blanks (LRB) are scattered throughout the analytical batch. Throughout the analytical batch, samples are chosen as laboratory duplicates and laboratory spikes to assess analyte precision and analyte recovery, respectively. The total number of duplicates and spikes performed will be equal or greater to ten percent of the total number of samples in the analytical batch.
- 11.15 As sample analysis is complete, results must be reviewed and accepted manually. If results fall outside acceptance limits, the sample should be reanalyzed. If sample result exceeds the highest standard of the calibration range it was run within, the samples can be automatically diluted by the instrument and reanalyzed. If the result is such that it will fall within a higher calibration range, it should be reanalyzed in that range. If the result is such that it will fall within a lower calibration range, it should be reanalyzed within that range.
- 11.16 User reviews salinity of samples. If any sample salinity concentration is greater than 20 ppt, the analyst reanalyzes the sample diluted to a user specified factor to obtain a salinity ≤ 10 ppt.
- 11.17 Upon completion of all analysis, results are saved to a daily report file. The file is named by the run date. The daily report file for analytical batch of January 1, 2005 would be named 010105. The file is converted to Microsoft Excel for data work up. Remaining samples are discarded.
- 11.18 All reagents are removed from the reagent chamber and returned to the refrigerator or dark cabinet. Reagents that have exceeded their stability period are discarded.
- 11.19 Aquakem Cleaning Solution is inserted into the instrument and shut down procedures are initiated. Daily files are cleared from the instrument software, the software is exited and the instrument is shut down. The computer is shut down.
- 11.20 The waste is flushed down the drain with copious amounts of tap water. The waste cuvette box is moved to the fume hood.

12 DATA ANALYSIS AND CALCULATIONS

- 12.1 Upon completion of all analysis, results are saved to a daily report file. The file is named by the run date. The daily report file for analytical batch of January 1, 2005 would be named 010105. The file is converted to Microsoft Excel for data work up. The instrument software has calculated final sample

concentration from the designated standard curve, correcting each concentration for associated blank response and also for any user or instrument specified dilution. Dilution by the instrument is noted by software as analysis ensues and, also, documented in the Excel data report file. The analyst examines each row of data. Results are eliminated that are outside the limits of the calibration range, or have an unrepeated blank response measurement greater than 0.005 absorbance units.

- 12.2 The analyst examines all data that were diluted and reanalyzed to obtain a diluted sample salinity of ≤ 10 ppt. If the response of the diluted sample is > 0.050 absorbance units and the appropriate blank response as described in Section 11.10 is also obtained, the results are accepted. If the response of the diluted sample is < 0.050 absorbance units, CBL Nutrient Analytical Services Laboratory's empirically derived salinity correction is applied to the original undiluted reported concentration.

Salinity Corrected mg NH₄-N/L = (((100 - ((-1.14 X ppt sample salinity) + 116)) / 100) + 1) X uncorrected mg NH₄-N/L)

13 METHOD PERFORMANCE

- 13.1 On 49 separate dates from January through November 2008, Reagent Blanks were performed on NH₄CBL as deionized water analyzed as a sample. This produced a mean value of 0.0032 mg NH₄-N/L, SD 0.0048.
- 13.2 On 52 separate dates from January through July 2008, 52 replicate analyses of SPEX® Corporation QC 6-42 NUT 1 were performed on NH₄CBL2. This produced a mean value of 0.0583 mg NH₄-N/L, SD 0.0045, Relative Percent Difference of 26% from the expected value of 0.079 \pm 10%. This is a mean recovery of 74%.
- 13.3 On 16 separate dates from November 2008 through February 2009, 15 replicate analyses of SPEX® Corporation QC 6-50 NUT 1 were performed on NH₄CBL2. This produced a mean value of 0.2078 mg NH₄-N/L, SD 0.0253, Relative Percent Difference of 4% from the expected value of 0.200 \pm 10%. This is a mean recovery of 104%.
- 13.4 For some estuarine samples analyzed on NH₄CBL in 2008, the mean difference in concentration between 76 duplicates analyzed on 13 separate dates was 0.0027 mg NH₄-N/L. The standard deviation of the difference between duplicates was 0.0030 NH₄-N/L.

14 REFERENCES

- 14.1 USEPA. 1979. Method No. 353.2 *in* Methods for chemical analysis of water and wastes. United States Environmental Protection Agency, Office of Research and Development. Cincinnati, Ohio. Report No. EPA-600/4-79-020 March 1979. 460pp.
- 14.2 Frank, J. M., C.F. Zimmermann and C. W. Keefe (2006). Comparison of results from Konelab Aquakem 250 and existing nutrient analyzers. UMCES CBL Nutrient Analytical Services Laboratory, Dec. 2006.

- 14.3 Solorzano, L. 1969. Determination of ammonia in natural waters by the phenolhypochlorite method. *Limnol. Oceanogr.* 14:799-801.
- 14.4 Parsons, T.R., Y. Maita and C.M. 1984. *A Manual of Chemical and Biological Methods for Seawater Analysis*, Pergamon Press, Elmsford, N.Y.
- 14.5 Kerouel, R. and A. Aminot. 1987. Procédure optimisée hors-contaminations pour l'analyse des éléments nutritifs dissous dans l'eau de mer. *Mar. Environ. Res* 22:19-32.

Determination of Dissolved Inorganic Nitrite (NO₂) in Fresh/Estuarine/Coastal Waters

1. SCOPE and APPLICATION

- 1.1 Nitrite reacts under acidic conditions with sulfanilamide to form a diazo compound that couples with N-1-naphthylethylenediamine dihydrochloride to quantitatively form a highly colored azo dye. The method is used to analyze all ranges of salinity.
- 1.2 A Method Detection Limit (MDL) of 0.0006 mg NO₂-N/L was determined as three times the standard deviation of seven low level replicates.
- 1.3 The Quantitation Limit for NO₂ was set at 0.0020 mg NO₂-N/L, or ten times the standard deviation of the MDL calculation.
- 1.4 The method is suitable for NO₂ concentrations 0.0020 to 0.280 mg NO₂-N/L.
- 1.5 This procedure should be used by analysts experienced in the theory and application of aqueous inorganic analysis. Three months experience with an experienced analyst, certified in the analysis of nitrite in aqueous samples is required.
- 1.6 This method can be used for all programs that require analysis of dissolved nitrite.
- 1.7 This procedure conforms to EPA Method 353.2 (1979).

2. SUMMARY

2.1 Filtered samples are diazotized with sulfanilamide and coupled with N-1-naphthylethylenediamine dihydrochloride to form a colored azo dye, yielding an intense pink color suitable for photometric measurement.

3. DEFINITIONS

- 3.1 Acceptance Criteria – Specified limits placed on characteristics of an item, process, or service defined in a requirement document. (ASQC)
- 3.2 Accuracy – The degree of agreement between an observed value and an accepted reference value. Accuracy includes a combination of random error (precision) and systematic error (bias) components which are due to sampling and analytical operations; a data quality indicator. (QAMS)
- 3.3 Aliquot – A discrete, measured, representative portion of a sample taken for analysis. (EPA QAD Glossary)
- 3.4 Analytical Range – 0.0020 to 0.280 mg NO₂-N/L. The overall analytical range is comprised of two distinct yet overlapping concentration ranges. A separate calibration is performed for each range. These ranges include 0.0020 to 0.042 mg NO₂-N/L, and 0.028

to 0.42 mg NO₂-N/L. Two sub-ranges are utilized so that samples can be analyzed on the most appropriate scale possible.

- 3.5 Batch – Environmental samples, which are prepared and /or analyzed together with the same process and personnel, using the same lot(s) of reagents. A **preparation batch** is composed of one to 200 environmental samples of the same matrix, meeting the above mentioned criteria and with a maximum time between the start of processing of the first and last sample in the batch to be 8 hours. An **analytical batch** is composed of prepared environmental samples (extracts, digestates, concentrates) and/or those samples not requiring preparation, which are analyzed together as a group using the same calibration curve or factor. An analytical batch can include samples originating from various environmental matrices and can exceed 20 samples. (NELAC/EPA)
- 3.6 Blank- A sample that has not been exposed to the analyzed sample stream in order to monitor contamination during sampling, transport, storage or analysis. The blank is subjected to the usual analytical and measurement process to establish a zero baseline or background value and is sometimes used to adjust or correct routine analytical results. (ASQC)
- 3.7 Calibrate- To determine, by measurement or comparison with a standard, the correct value of each scale reading on a device. The levels of the applied calibration standard should bracket the range of planned or expected sample measurements. (NELAC)
- 3.8 Calibration – The set of operations which establish, under specified conditions, the relationship between values indicated by a measuring device. The levels of the applied calibration standard should bracket the range of planned or expected sample measurements. (NELAC)
- 3.9 Calibration Blank – A volume of reagent water fortified with the same matrix as the calibration standards, without analyte added.
- 3.10 Calibration Curve – The graphical relationship between known values, such as concentrations, or a series of calibration standards and their analytical response. (NELAC)
- 3.11 Calibration Method – A defined technical procedure for performing a calibration. (NELAC)
- 3.12 Calibration Standard – A substance or reference material used to calibrate an instrument. (QAMS)
- 3.12.1 Initial Calibration Standard (STD) – A series of standard solutions used to initially establish instrument calibration responses and develop calibration curves for individual target analytes.
- 3.12.2 Initial Calibration Verification (ICV) – An individual standard, distinct from the Initial Calibration Standards (STD), analyzed initially, prior to any sample analysis, which verifies acceptability of the calibration curve or previously established calibration curve.

- 3.12.3 Continuing Calibration Verification (CCV) – An individual standard, distinct from the Initial Calibration Standards (STD), analyzed after every 15-20 field sample analyses.
- 3.13 Certified Reference Material – A reference material one or more of whose property values are certified by a technically valid procedure, accompanied by or traceable to a certificate or other documentation which is issued by a certifying body. (ISO 17025)
- 3.14 Corrective Action – Action taken to eliminate the causes of an existing nonconformity, defect or other undesirable situation in order to prevent recurrence. (ISO 8402)
- 3.15 Deficiency – An unauthorized deviation from acceptable procedures or practices. (ASQC)
- 3.16 Demonstration of Capability – A procedure to establish the ability of the analyst to generate acceptable accuracy. (NELAC)
- 3.17 Detection Limit – The lowest concentration or amount of the target analyte that can be determined to be different from zero by a single measurement at a stated degree of confidence.
- 3.18 Duplicate Analysis – The analyses of measurements of the variable of interest performed identically on two sub samples (aliquots) of the same sample. The results from duplicate analyses are used to evaluate analytical or measurement precision but not the precision of sampling, preservation or storage internal to the laboratory. (EPA-QAD)
- 3.19 External Standard (ES) – A pure analyte (Sodium Nitrite (NaNO_2)) that is measured in an experiment separate from the experiment used to measure the analyte(s) in the sample. The signal observed for a known quantity of the pure external standard is used to calibrate the instrument response for the corresponding analyte(s). The instrument response is used to calculate the concentrations of the analyte(s) in the unknown sample.
- 3.20 Field Duplicates (FD1 and FD2) – Two separate samples collected at the same time and place under identical circumstances and treated exactly the same throughout field and laboratory procedures. Analyses of FD1 and FD2 provide a measure of the precision associated with sample collection, preservation and storage, as well as with laboratory procedures.
- 3.21 Holding time – The maximum time that samples may be held prior to analysis and still be considered valid. (40 CFR Part 136) The time elapsed from the time of sampling to the time of extraction or analysis, as appropriate.
- 3.22 Laboratory Duplicates (LD1 and LD2) – Two aliquots of the same sample taken in the laboratory and analyzed separately with identical procedures. Analyses of LD1 and LD2 indicate precision associated with laboratory procedures, but not with sample collection, preservation, or storage procedures.
- 3.23 Laboratory Reagent Blank (LRB) – A blank matrix (i.e., DI water) that is treated exactly as a sample including exposure to all glassware,

equipment, solvents, and reagents that are used with other samples. The LRB is used to determine if method analytes or other interferences are present in the laboratory environment, the reagents, or the instrument.

- 3.24 Laboratory Control Sample (LCS) – A sample matrix, free from the analytes of interest, spiked with verified known amounts of analytes from a source independent of the calibration standard or a material containing known and verified amounts of analytes. The LCS is generally used to establish intra-laboratory or analyst-specific precision and bias or to assess the performance of all or a portion of the measurement system. (NELAC)
- 3.25 Limit of Detection (LOD) – The lowest concentration level that can be determined by a single analysis and with a defined level of confidence to be statistically different from a blank. (ACS)
- 3.26 Limit of Quantitation (LOQ) – The minimum levels, concentrations, or quantities of a target variable (target analyte) that can be reported with a specified degree of confidence. The LOQ is set at 3 to 10 times the LOD, depending on the degree of confidence desired.
- 3.27 Linear Dynamic Range (LDR) – The absolute quantity over which the instrument response to an analyte is linear. This specification is also referred to as the Linear Calibration Range (LCR).
- 3.28 Material Safety Data Sheets (MSDS) – Written information provided by vendors concerning a chemical's toxicity, health hazards, physical properties, fire, and reactivity data including storage, spill, and handling precautions.
- 3.29 May – Denotes permitted action, but not required action. (NELAC)
- 3.30 Method Detection Limit (MDL) – The minimum concentration of an analyte that can be identified, measured, and reported with 99% confidence that the analyte concentration is greater than zero (Standard Methods).
- 3.31 Must – Denotes a requirement that must be met. (Random House College Dictionary)
- 3.32 Photometer – measures the absorbance of the solution in the cell in a multicell cuvette. Light passes from the lamp through the condensing lenses to the interference filter. The plane surface of the first condensing lens is coated with a material which reflects heat and infrared light. The filters are mounted on a filter wheel. There are 15 positions for filters. Each filter corresponds to a wavelength of interest. The 540 nm filter is specified by the test definition for nitrite. After passing through the filter the light is converted into a stream of light pulses by a chopper. Then the light is directed via a quartz fiber through a focusing lens and a slit to the beam divider. The beam divider divides the light into two parts. A specified portion is reflected to the reference detector, which monitors the light level fluctuations.

The remaining major portion of the light beam goes through the liquid in the cell to the signal detector, which measures the amount of light absorbed.

- 3.33 Precision – The degree to which a set of observations or measurements of the same property, obtained under similar conditions, conform to themselves; a data quality indicator. Precision is usually expressed as standard deviation, variance or range, in either absolute or relative terms. (NELAC)
- 3.34 Preservation – Refrigeration, freezing, and/or reagents added at the time of sample collection (or later) to maintain the chemical and or biological integrity of the sample.
- 3.35 Quality Control Sample (QCS) – A sample of analyte of known and certified concentration. The QCS is obtained from a source external to the laboratory and different from the source of calibration standards. It is used to check laboratory performance with externally prepared test materials.
- 3.36 Run Cycle – Typically a day of operation – the entire analytical sequence from sampling the first standard to the last sample of the day.
- 3.37 Sample Segment – Bar-coded metal tray that holds up to fourteen four milliliter auto analyzer vials containing samples or standards. The user identifies each vial in the operating software.
- 3.38 Sample Segment Holder – An automated temperature controlled carousel that contains up to six sample segments. This carousel spins in clockwise or counterclockwise manner to move the sample segments into position for analysis. This carousel format allows for continuous processing.
- 3.39 Sensitivity – The capability of a test method or instrument to discriminate between measurement responses representing different levels (concentrations) of a variable of interest.
- 3.40 Shall – Denotes a requirement that is mandatory whenever the criterion for conformance with the specification requires that there be no deviation. (ANSI)
- 3.41 Should – Denotes a guideline or recommendation whenever noncompliance with the specification is permissible. (ANSI)
- 3.42 Standard Reference Material (SRM) – Material which has been certified for specific analytes by a variety of analytical techniques and/or by numerous laboratories using similar analytical techniques. These may consist of pure chemicals, buffers, or compositional standards. The materials are used as an indication of the accuracy of a specific analytical technique.
- 3.43 Test Definition – A photometric test consisting of a user defined testing sequence, reagent additions, calibration standards, incubations and absorption results.
- 3.44 Test Flow – Functions to define the parameter for reagent and sample dispensing, dilution, incubation and measurement.

4 INTERFERENCES

- 4.1 Suspended matter in the sample will scatter light as it passes through the cuvette to the detector. High blank responses will result. The identified sample will be reanalyzed.
- 4.2 Blemishes in the cuvette, as result of the manufacturing process, will result in high blank responses. The identified sample will be reanalyzed.

5 SAFETY

- 5.1 Safety precautions must be taken when handling reagents, samples and equipment in the laboratory. Protective clothing including lab coats, safety glasses and enclosed shoes should be worn. In certain situations, it will be necessary to also use gloves and/or a face shield. If solutions come in contact with eyes, flush with water continuously for 15 minutes. If solutions come in contact with skin, wash thoroughly with soap and water. Contact Solomons Rescue Squad (911) if emergency treatment is needed and also inform the CBL Business Manager of the incident. Contact the CBL Business Manager if additional treatment is required.
- 5.2 The toxicity or carcinogenicity of each reagent used in this procedure may not have been fully established. Each chemical should be regarded as a potential health hazard and exposure should be as low as reasonably achievable. Cautions are included for known hazardous materials and procedures.
- 5.3 Do not wear jewelry when troubleshooting electrical components. Even low voltage points are dangerous and can injure if allowed to short circuit.
- 5.4 The following hazard classifications are listed for the chemicals used in this procedure. Detailed information is provided on Material Safety Data Sheets (MSDS).

Chemical	Health	Flammability	Reactivity	Contact	Storage
Hydrochloric acid	3	0	2	4	White
Sulfanilamide	0	1	1	1	Green
N-1-naphthylethylenediamine dihydrochloride	2	1	1	2	Green
Sodium Nitrite	2	0	3	2	Yellow
Chloroform	3	1	1	3	Blue
Clorox	3	0	2	4	White

On a scale of 0 to 4 the substance is rated on four hazard categories: health, flammability, reactivity, and contact. (0 is non-hazardous and 4 is extremely hazardous)

STORAGE

Red – Flammability Hazard: Store in a flammable liquid storage area.

Blue – Health Hazard: Store in a secure poison area.

Yellow – Reactivity Hazard: Keep separate from flammable and combustible materials.

White – Contact Hazard: Store in a corrosion-proof area.

Green – Use general chemical storage (On older labels, this category was orange).

Striped – Incompatible materials of the same color class have striped labels. These products should not be stored adjacent to substances with the same color label. Proper storage must be individually determined.

6 EQUIPMENT AND SUPPLIES

- 6.1 Aquakem 250 multi-wavelength automated discrete photometric analyzer. Aquakem 250 control software operates on a computer running Microsoft Windows NT or XP operating system.
- 6.2 Freezer, capable of maintaining $-20 \pm 5^\circ \text{C}$.
- 6.3 Lab ware – All reusable lab ware (glass, Teflon, plastic, etc) should be sufficiently clean for the task objectives. This laboratory cleans all lab ware related to this method with a 10% HCl (v/v) acid rinse.

7 REAGENTS AND STANDARDS

- 7.1 Purity of Water – Unless otherwise indicated, references to water shall be understood to mean reagent water conforming to Specification D 1193, Type I. Freshly prepared water should be used for making the standards intended for calibration. The detection limits of this method will be limited by the purity of the water and reagents used to make the standards.
- 7.2 Purity of Reagents – Reagent grade chemicals shall be used in all tests. Unless otherwise indicated, it is intended that all reagents shall conform to specifications of the Committee on Analytical Reagents of the American Chemical Society, where such specifications are available. Other grades may be used, provided it is first ascertained that the reagent is of sufficiently high purity to permit its use without compromising the accuracy of the determination.
- 7.3 Sulfanilamide solution
- | | |
|---|-------|
| Hydrochloric acid (HCl), concentrated | 25 mL |
| Sulfanilimide ($\text{C}_6\text{H}_8\text{N}_2 \text{O}_2\text{S}$) | 2.5 g |
- In a 500 mL volumetric flask, add approximately 400 mL deionized water. Add 25 mL HCl to the deionized water. Add 2.5 g sulfanilamide and bring to volume. Write name of preparer, preparation date, reagent manufacturer, manufacturer's lot number in the Analytical Reagent log book. Store flask in refrigerator. Reagent is stable for one year.
- 7.4 N-1-naphylethylenediamine dihydrochloride solution

N-1-naphylethylenediamine dihydrochloride ($\text{C}_{12}\text{H}_{14}\text{N}_2 \cdot 2\text{HCl}$)	0.25 g
---	--------

In a 500 mL volumetric flask, dissolve 0.25 g N-1-naphylethylenediamine dihydrochloride in approximately 400 mL deionized water. Bring flask to volume. Store flask in light resistant container in refrigerator. Write name of preparer, preparation date, reagent manufacturer, manufacturer's lot number in the Analytical Reagent log book. Reagent is stable for six months.

- 7.5 Nitrite Stock Standard, 5,000 μM –

Sodium nitrite (NaNO_2), primary standard grade, dried at 45°C	0.345 g
Deionized water	up to 1000 mL

In a 1000 mL volumetric flask, dissolve 0.345 g of sodium nitrite in ~800 mL of deionized water. Dilute to 1000 mL with deionized water (1 mL contains 5 $\mu\text{moles N}$). Add 1 mL of chloroform as a preservative. Write name of preparer, preparation date, standard manufacturer, manufacturer lot number in the Analytical Standard log book. Make fresh every 4 months.

7.6 Secondary Nitrite Standard –

Stock Nitrite Standard	0.80 mL
Deionized water	up to 100 mL

In a volumetric flask, dilute 0.80 mL of Stock Nitrite Standard to 100 mL with deionized water to yield a concentration of 40 $\mu\text{M NO}_2^-/\text{N/L}$ (0.56 mg N/L). Write name of preparer, preparation date, Nitrite Stock Standard preparation date in the Analytical Standard log book. Make fresh every month.

7.7 Working Regular Nitrite Standard –

Secondary Nitrite Standard	7.50 mL
----------------------------	---------

In a 100 mL volumetric flask, dilute 7.50 mL of Secondary Nitrite Standard to volume with deionized water to yield a concentration of 3.0 $\mu\text{M NO}_2^-/\text{N/L}$ (0.042 mg N/L). Write name of preparer, preparation date, Secondary Nitrite Standard preparation date in the Analytical Standard log book. Make fresh every month.

7.8 Working High Nitrite Standard –

Nitrite Stock Standard	0.40 mL
------------------------	---------

In a 100 mL volumetric flask, dilute 0.40 mL of Stock Nitrite Standard to volume with deionized water to yield a concentration of 20.0 $\mu\text{M NO}_2^-/\text{N/L}$ (0.28 mg N/L). Write name of preparer, preparation date, Nitrite Stock Standard preparation date in the Analytical Standard log book. Make fresh every month.

7.9 Aquakem Cleaning Solution –

Clorox	75.0 mL
--------	---------

In a 100 mL volumetric flask, dilute 75.0 mL of Clorox to volume with deionized water to yield a concentration of 75% Clorox. Write name of preparer, preparation date, reagent manufacturer, manufacturer lot number in the Analytical Reagent log book. Reagent is stable for six months.

8 SAMPLE COLLECTION, PRESERVATION, AND STORAGE

8.1 Water collected for nitrite should be filtered through a Whatman GF/F glass fiber filter (nominal pore size 0.7 μm), or equivalent.

8.2 Water collected for nitrite should be frozen at -20° C. The AutoAnalyzer vial container should be clean and sample rinsed.

8.3 Frozen nitrite samples may be stored up to 28 days. It has been shown that frozen QCS samples up to a year old still fall well within the control limits.

8.4 Nitrite samples may be refrigerated at 4° C for no longer than one day.

9 QUALITY CONTROL

9.1 The laboratory is required to operate a formal quality control (QC) program. The minimum requirements of this program consist of an initial demonstration of laboratory capability and the continued analysis of laboratory instrument blanks and calibration standard material, analyzed as samples, as a continuing check on performance. The laboratory is required to maintain performance records that define the quality of data generated.

9.2 Initial Demonstration of Performance

- 9.2.1 The initial demonstration of capability (nitrite) – is used to characterize instrument performance (MDLs) and laboratory performance (analysis of QC samples) prior to the analyses conducted by this procedure.
- 9.2.2 Linear Dynamic Range – LDR (Linear Calibration Range) should be established for nitrite using appropriate five point calibration curve.
- 9.2.3 Quality Control Sample (QCS/SRM) – When using this procedure, a quality control sample is required to be analyzed at the beginning and end of the run, to verify data quality and acceptable instrument performance. If the determined concentrations are not within $\pm 10\%$ of the certified values, performance of the determinative step of the method is unacceptable. The source of the problem must be identified and corrected before either proceeding with the initial determination of MDLs or continuing with analyses.
- 9.2.4 Method Detection Limits (MDLs) – MDLs should be established for nitrite using a low level ambient water sample. To determine the MDL values, analyze seven replicate aliquots of water. Perform all calculations defined in the procedure (Section 12) and report the concentration values in the appropriate units. Calculate the MDL as follows:

$$\text{MDL} = s \times 3$$

Where, s = Standard Deviation of the replicate analyses.

- 9.2.5 MDLs shall be determined yearly and whenever there is a significant change in instrument response, a significant change in instrument configuration, or a new matrix is encountered.

9.3 Assessing Laboratory Performance

- 9.3.1 Laboratory Reagent Blank (LRB) – The laboratory must analyze at least one LRB with each batch of samples. The LRB consists of Nanopure water treated the same as the samples. Analyte found in LRB indicates possible reagent or laboratory environment contamination. LRB data are used to assess and correct contamination from the laboratory environment. LRB above the lowest standard requires that the source of the problem must be identified and corrected before proceeding with analyses.
- 9.3.2 Quality Control Sample (QCS)/ Standard Reference Material (SRM) – When using this procedure, a quality control sample is required to be analyzed at the beginning of the run and end of the run, to verify data quality and acceptable instrument performance. If the determined concentrations are not within $\pm 3s$ of the certified values, performance of the determinative step of the method is unacceptable. The source of the problem must be identified and corrected before either proceeding with the initial determination of MDLs or continuing with the analyses. The results of these QCS/SRM samples shall be used to determine batch acceptance.
- 9.3.3 The QCS are obtained from a source external to the laboratory and different from the source of calibration standards.
- 9.3.4 Control Charts – The Accuracy Control Chart for QCS/SRM samples is constructed from the average and standard deviation of the 20 most recent QCS/SRM measurements. The accuracy chart includes upper and lower warning levels ($WL=\pm 2s$) and upper and lower control levels ($CL=\pm 3s$). These values are derived from stated values of the QCS/SRM. The standard deviation (s) is specified relative to statistical confidence levels of 95% for WLs and 99% for CLs. Set up an accuracy chart by using percent recovery since the concentration of the QCS/SRM varies. Enter QCS/SRM results on the chart each time the sample is analyzed
- 9.3.5 Continuing Calibration Verification (CCV) – Following every 18-23 samples, one CCV of 2.0 $\mu\text{M NO}_2\text{-N/L}$ (0.028 mg N/L) Regular NO₂, 15 $\mu\text{M NO}_2\text{-N/L}$ (0.21 mg N/L) NO₂HIGH, is analyzed to assess instrument performance. The CCVs are made from the same material as calibration standards (NaNO_2), and are to be within $TV \pm 3s$. Failure to meet the criteria requires correcting the problem, including reanalysis of any affected samples. If not enough sample exists, the data must be qualified if reported.
- 9.3.6 Reagent Blank – The Reagent Blank Control Chart for Reagent Blank samples is constructed from the average and standard deviation of the 20 most recent Reagent Blank measurements. The accuracy chart includes upper and lower warning levels ($WL=\pm 2s$) and upper and lower control levels ($CL=\pm 3s$). The standard deviation (s) is specified

relative to statistical confidence levels of 95% for WLs and 99% for CLs. Enter Reagent Blank results on the chart each time the Reagent Blank is analyzed.

9.4 Assessing Analyte Recovery - % Recovery

- 9.4.1 Analyte recovery is assessed through percent recoveries of laboratory spikes of samples.
- 9.4.2 $\% \text{ Recovery} = (\text{Spiked sample concentration} - \text{Sample concentration} / \text{Concentration of spike solution}) \times 100$

9.5 Assessing Analyte Precision – Relative Percent Difference

- 9.5.1 Analyte replication is assessed through duplicate analyses of samples – Relative Percent Difference.
- 9.5.2 $\text{RPD} = (\text{Laboratory Duplicate Result 1} - \text{Laboratory Duplicate Result 2}) / [(\text{Laboratory Duplicate Result 1} + \text{Laboratory Duplicate Result 2}) / 2] \times 100$

9.6 Corrective Actions for Out of Control Data

- 9.6.1 Control limit – If one measurement exceeds Accuracy Control Chart CL, repeat the analysis immediately. If the repeat measurement is within the CL, continue analyses; if it exceeds the CL, discontinue analyses and correct the problem.
- 9.6.2 Warning limit – If two out of three successive points exceed Accuracy Control Chart WL, analyze another sample. If the next point is within WL, continue analyses; if the next point exceeds the WL, evaluate potential bias and correct the problem.
- 9.6.3 Trending – If seven successive Accuracy Control Chart measurements are on the same side of the central line, discontinue analyses and correct the problem.
- 9.6.4 When external QCS samples are out of control, correct the problem. Reanalyze the samples analyzed between the last in-control measurement and the out-of-control one.
- 9.6.5 When external CCV samples are out of control, correct the problem. Reanalyze the samples analyzed between the last in-control measurement and the out-of-control one.

9.7 General Operation - To assure optimal operation and analytical results, the Reagent Blank and CCV are tracked daily in the raw data file, copied to Reagent Blank and CCV Control Charts.

10 CALIBRATION AND STANDARDIZATION

10.1 Calibration – Daily calibration must be performed before sample analysis may begin. Five point calibrations are used with each of the two sub-calibrations that cover the analytical range. Two working nitrite standards are used to produce the calibrators for each set of two calibration curves. The instrument performs

serial dilutions of working standards to produce the five calibrators defined for each curve. The following outlines the preparation of the working standards and the following table describes the subsequent serial dilutions the instrument performs to make each standard for each of the two calibration curves.

Nitrite Working Standards:

Regular NO₂ (NO₂CBL)

Working Standard 0.042 mg N/L (7.5 mL secondary standard to 100 mL)

Working CCV 0.028 mg N/L (5.0 mL secondary standard to 100 mL)

NO₂HIGH

Working Standard 0.28 mg N/L (0.4 mL stock standard to 100 mL)

Working CCV 0.21 mg N/L (0.3 mL stock standard to 100 mL)

Nitrite Calibrators:

Test Name	Working Standard	Dilution Factor	Concentration mg N/L
NO ₂ CBL	0.042 mg N/L	1+9	0.0042
	0.042 mg N/L	1+4	0.0084
	0.042 mg N/L	1+2	0.014
	0.042 mg N/L	1+1	0.021
	0.042 mg N/L	1+0	0.042
NO ₂ HIGH	0.28 mg N/L	1+9	0.028
	0.28 mg N/L	1+5	0.04667
	0.28 mg N/L	1+2	0.09333
	0.28 mg N/L	1+1	0.14
	0.28 mg N/L	1+0	0.28

10.2 The instrument software prepares a standard curve for each set of calibrators.

A graph plotting measured absorbance against standard concentration is presented for review and approval. If acceptance criteria are not met the entire curve can be reanalyzed or individual standards can be reanalyzed. One standard value (original or reanalyzed) for each and every standard is incorporated in the curve. The coefficient of determination (Person's r value) for the calibration curve as well as the calculated concentration of each calibrator is reviewed. The calculated value of each calibrator must be within ten percent of the expected value. The coefficient of determination (Person's r value) for the calibration curve must be greater than 0.980.

11 PROCEDURE – DAILY OPERATIONS QUALITY CONTROL

- 11.1 Turn on computer. Computer will automatically initiate Konelab software. Once software is running, turn on instrument and allow connection between instrument and computer to complete.
- 11.2 Discard any water remaining in the water reservoir from the previous analytical run. Fill the water reservoir with fresh deionized water.
- 11.3 Remove samples from freezer that will be analyzed that day. Allow samples to begin thawing. Begin daily bench sheet documentation.
- 11.4 Once water reservoir is full, “perform washes” – complete five wash cycles and then initiate “start-up” at main menu.
- 11.5 Gather working standards and reagents from refrigerator during startup. Assess standards and reagents. Remake anything that has exceeded the time over which it is considered stable.
- 11.6 Once startup is complete, check that the instrument water blank of water from the reservoir has performed within acceptance limits. If any of the instrument functions are outside their predefined and software controlled limits, the user will be notified on the main menu page. User takes corrective action to return instrument functions to controlled limits.
- 11.7 Load reagents in specified position in reagent carousel and place in refrigerated reagent compartment.
- 11.8 Load working standards in a sample segment, identify the standards in their positions from the drop down menus at the individual segment positions, and load into instrument.
- 11.9 Select the methods to be calibrated. Two methods will be calibrated – NO2CBL, and NO2HIGH are the method names to be selected in the software.
- 11.10 Begin calibration – See test flow below for stepwise instrument functions for the analysis of standards and samples.

Test Flow – Method of Analysis, Stepwise

- 145 µL sample to cuvette with mixing
- Blank response measurement at 540 nm
- 50 µL Sulfanilamide Reagent to cuvette with mixing
- 50 µL N-1-naphthylethylenediamine dihydrochloride Reagent to cuvette with mixing
- Incubation, 420 seconds, 37°C
- End point absorbance measurement, 540 nm
- Software processes absorbance value, blank response value and uses calibration curve to calculate analyte concentration (mg/L N as NO₂)
- User is notified if any measured values used to calculate final concentration are outside preset limits. If so, analyst has options to accept result, rerun the sample or rerun the sample diluted to a user or software specified factor.
- User is notified of each blank response value. Blank response >0.002 absorbance units indicates a scratched cuvette or turbid sample. If the blank response value exceeds 0.002 absorbance units, the analyst specifies that the sample is reanalyzed. If the blank response value of the reanalyzed sample is <0.002 absorbance units, the reanalyzed

- result is accepted. If the same concentration and blank response value >0.002 absorbance units is again obtained, the results are accepted.
- 11.11 Organize samples, reagent blanks, check standards and all quality control samples while instrument performs calibrations.
 - 11.12 As calibration curves are produced by the instrument, review them for acceptability. The instrument software prepares a standard curve for each set of calibrators. A graph plotting measured absorbance against standard concentration is presented for review and approval. If acceptance criteria are not met, either the entire curve shall be reanalyzed or individual standards shall be reanalyzed, depending on the violation. One standard value (original or reanalyzed) for each and every calibrator is incorporated in the curve.
 - 11.13 Once calibration curves are accepted, samples are loaded into the sample segments and loaded into the instrument for analysis. After the Reagent Blank, the first sample analyzed should be an ICV (initial calibration verification) sample. There should be one ICV sample for each calibration curve, of a concentration close to the middle of each range. The following are the usual ICV samples for each curve: 0.028 mg N/L for NO₂CBL and 0.21 mg N/L for NO₂HIGH.
 - 11.14 Samples are loaded into the segments and analyzed. CCV (Continuing Calibration Verification) samples (one for each of the three calibration ranges) follow every 18-23 samples. Standard Reference Material (SRM) samples, as well as Laboratory Reagent Blanks (LRB) are scattered throughout the analytical batch. Throughout the analytical batch, samples are chosen as laboratory duplicates and laboratory spikes to assess analyte precision and analyte recovery, respectively. The total number of duplicates and spikes performed will be equal or greater to ten percent of the total number of samples in the analytical batch.
 - 11.15 As sample analysis is complete, results must be reviewed and accepted manually. If results fall outside acceptance limits, the sample should be reanalyzed. If sample result exceeds the highest standard of the calibration range it was run within, the samples can be automatically diluted by the instrument and reanalyzed. If the result is such that it will fall within a higher calibration range, it should be reanalyzed in that range. If the result is such that it will fall within a lower calibration range, it should be reanalyzed within that range.
 - 11.16 Upon completion of all analysis, results are saved to a daily report file. The file is named by the run date. The daily report file for analytical batch of January 1, 2005 would be named 010105. The file is converted to Microsoft Excel for data work up. Remaining samples are discarded.
 - 11.17 All reagents are removed from the reagent chamber and returned to the refrigerator. Reagents that have exceeded their stability period are discarded.
 - 11.18 Aquakem Cleaning Solution is inserted into the instrument and shut down procedures are initiated. Daily files are cleared from the instrument software, the software is exited and the instrument is shut down. The computer is shut down.
 - 11.19 The waste is flushed down the drain with copious amounts of tap water. The waste cuvette box is moved to the fume hood.

12 DATA ANALYSIS AND CALCULATIONS

- 12.1 Upon completion of all analysis, results are saved to a daily report file. The file is named by the run date. The daily report file for analytical batch of January 1, 2005 would be named 010105. The file is converted to Microsoft Excel for data work up. The instrument software has calculated final sample concentration from the designated standard curve, correcting each concentration for associated blank response and also for any user or instrument specified dilution. Dilution by the instrument is noted by software as analysis ensues and, also, documented in the Excel data report file. The analyst examines each row of data. Results are eliminated that are outside the limits of the calibration range, or have an unrepeated blank response measurement greater than 0.002 absorbance units.

13 METHOD PERFORMANCE

- 13.1 On 26 separate dates from January through June 2008, Reagent Blanks were performed on NO₂CBL as deionized water analyzed as a sample. This produced a mean value of 0.000088 mg NO₂-N/L, SD 0.000091.
- 13.2 For some estuarine samples analyzed on NO₂CBL in 2008, the mean difference in concentration between 78 duplicates analyzed on 13 separate dates was 0.00027 mg NO₂-N/L. The standard deviation of the difference between duplicates was 0.00028 NO₂-N/L.

14 REFERENCES

- 14.1 USEPA. 1979. Method No. 353.2 *in* Methods for chemical analysis of water and wastes. United States Environmental Protection Agency, Office of Research and Development. Cincinnati, Ohio. Report No. EPA-600/4-79-020 March 1979. 460pp.
- 14.2 Frank, J. M., C.F. Zimmermann and C. W. Keefe (2006). Comparison of results from Konelab Aquakem 250 and existing nutrient analyzers. UMCES CBL Nutrient Analytical Services Laboratory, Dec. 2006.
- 14.3 Strickland, J.D.H. and T.R. Parsons. 1965. A Manual of Sea Water Analysis, 2nd ed. Fisheries Research Board of Canada, Ottawa.

Determination of Dissolved Inorganic Orthophosphate (PO₄) in Fresh/Estuarine/Coastal Waters

1. SCOPE and APPLICATION

- 1.1 Ammonium molybdate and potassium antimony tartrate react in an acid medium with dilute solutions of orthophosphate to form an antimony-phosphomolybdate complex which is reduced to an intensely blue-colored complex by ascorbic acid. Color is proportional to orthophosphate concentration. The method is used to analyze all ranges of salinity.
- 1.2 A Method Detection Limit (MDL) of 0.0007 mg PO₄-P/L was determined as three times the standard deviation of seven low level replicates.
- 1.3 The Quantitation Limit for PO₄-P was set at 0.0025 mg PO₄-P /L, or ten times the standard deviation of the MDL calculation.
- 1.4 The method is suitable for PO₄-P concentrations 0.0025 to 1.488 mg PO₄-P/L.
- 1.5 This procedure should be used by analysts experienced in the theory and application of aqueous inorganic analysis. Three months experience with an experienced analyst, certified in the analysis of orthophosphate in aqueous samples by is required.
- 1.6 This method can be used for all programs that require analysis of dissolved orthophosphate.
- 1.7 This procedure conforms to EPA Method 365.1 (1979).

2. SUMMARY

- 2.1 Filtered samples are mixed with a sulfuric acid-antimony-molybdate solution, and subsequently with an ascorbic acid solution, yielding an intense blue color suitable for photometric measurement.

3. DEFINITIONS

- 3.1 Acceptance Criteria – Specified limits placed on characteristics of an item, process, or service defined in a requirement document. (ASQC)
- 3.2 Accuracy – The degree of agreement between an observed value and an accepted reference value. Accuracy includes a combination of random error (precision) and systematic error (bias) components which are due to sampling and analytical operations; a data quality indicator. (QAMS)
- 3.3 Aliquot – A discrete, measured, representative portion of a sample taken for analysis. (EPA QAD Glossary)
- 3.4 Analytical Range – 0.0025 to 1.488 mg PO₄-P/L. The overall analytical range is comprised of three distinct yet overlapping

concentration ranges. A separate calibration is performed for each range. These ranges include 0.0025 to 0.0558 mg PO₄-P/L, 0.0186 to 0.186 mg PO₄-P/L and 0.1488 to 1.488 mg PO₄-P/L. Three sub-ranges are utilized so that samples can be analyzed on the most appropriate scale possible.

- 3.5 **Batch** – Environmental samples, which are prepared and /or analyzed together with the same process and personnel, using the same lot(s) of reagents. A **preparation batch** is composed of one to 200 environmental samples of the same matrix, meeting the above mentioned criteria and with a maximum time between the start of processing of the first and last sample in the batch to be 8 hours. An **analytical batch** is composed of prepared environmental samples (extracts, digestates, concentrates) and/or those samples not requiring preparation, which are analyzed together as a group using the same calibration curve or factor. An analytical batch can include samples originating from various environmental matrices and can exceed 20 samples. (NELAC/EPA)
- 3.6 **Blank**- A sample that has not been exposed to the analyzed sample stream in order to monitor contamination during sampling, transport, storage or analysis. The blank is subjected to the usual analytical and measurement process to establish a zero baseline or background value and is sometimes used to adjust or correct routine analytical results. (ASQC)
- 3.7 **Calibrate**- To determine, by measurement or comparison with a standard, the correct value of each scale reading on a device. The levels of the applied calibration standard should bracket the range of planned or expected sample measurements. (NELAC)
- 3.8 **Calibration** – The set of operations which establish, under specified conditions, the relationship between values indicated by a measuring device. The levels of the applied calibration standard should bracket the range of planned or expected sample measurements. (NELAC)
- 3.9 **Calibration Blank** – A volume of reagent water fortified with the same matrix as the calibration standards, without analyte added.
- 3.10 **Calibration Curve** – The graphical relationship between known values, such as concentrations, or a series of calibration standards and their analytical response. (NELAC)
- 3.11 **Calibration Method** – A defined technical procedure for performing a calibration. (NELAC)
- 3.12 **Calibration Standard** – A substance or reference material used to calibrate an instrument. (QAMS)
- 3.12.1 **Initial Calibration Standard (STD)** – A series of standard solutions used to initially establish instrument calibration responses and develop calibration curves for individual target analytes.
- 3.12.2 **Initial Calibration Verification (ICV)** – An individual standard, distinct from the Initial Calibration Standards

- (STD), analyzed initially, prior to any sample analysis, which verifies acceptability of the calibration curve or previously established calibration curve.
- 3.12.3 Continuing Calibration Verification (CCV) – An individual standard, distinct from the Initial Calibration Standards (STD), analyzed after every 15-20 field sample analyses.
- 3.13 Certified Reference Material – A reference material one or more of whose property values are certified by a technically valid procedure, accompanied by or traceable to a certificate or other documentation which is issued by a certifying body. (ISO 17025)
- 3.14 Corrective Action – Action taken to eliminate the causes of an existing nonconformity, defect or other undesirable situation in order to prevent recurrence. (ISO 8402)
- 3.15 Deficiency – An unauthorized deviation from acceptable procedures or practices. (ASQC)
- 3.16 Demonstration of Capability – A procedure to establish the ability of the analyst to generate acceptable accuracy. (NELAC)
- 3.17 Detection Limit – The lowest concentration or amount of the target analyte that can be determined to be different from zero by a single measurement at a stated degree of confidence.
- 3.18 Duplicate Analysis – The analyses of measurements of the variable of interest performed identically on two sub samples (aliquots) of the same sample. The results from duplicate analyses are used to evaluate analytical or measurement precision but not the precision of sampling, preservation or storage internal to the laboratory. (EPA-QAD)
- 3.19 External Standard (ES) – A pure analyte (Potassium dihydrogen phosphate (KH_2PO_4)) that is measured in an experiment separate from the experiment used to measure the analyte(s) in the sample. The signal observed for a known quantity of the pure external standard is used to calibrate the instrument response for the corresponding analyte(s). The instrument response is used to calculate the concentrations of the analyte(s) in the unknown sample.
- 3.20 Field Duplicates (FD1 and FD2) – Two separate samples collected at the same time and place under identical circumstances and treated exactly the same throughout field and laboratory procedures. Analyses of FD1 and FD2 provide a measure of the precision associated with sample collection, preservation and storage, as well as with laboratory procedures.
- 3.21 Holding time – The maximum time that samples may be held prior to analysis and still be considered valid. (40 CFR Part 136) The time elapsed from the time of sampling to the time of extraction or analysis, as appropriate.
- 3.22 Laboratory Duplicates (LD1 and LD2) – Two aliquots of the same sample taken in the laboratory and analyzed separately with identical procedures. Analyses of LD1 and LD2 indicate precision associated

- with laboratory procedures, but not with sample collection, preservation, or storage procedures.
- 3.23 Laboratory Reagent Blank (LRB) – A blank matrix (i.e., DI water) that is treated exactly as a sample including exposure to all glassware, equipment, solvents, and reagents that are used with other samples. The LRB is used to determine if method analytes or other interferences are present in the laboratory environment, the reagents, or the instrument.
- 3.24 Laboratory Control Sample (LCS) – A sample matrix, free from the analytes of interest, spiked with verified known amounts of analytes from a source independent of the calibration standard or a material containing known and verified amounts of analytes. The LCS is generally used to establish intra-laboratory or analyst-specific precision and bias or to assess the performance of all or a portion of the measurement system. (NELAC)
- 3.25 Limit of Detection (LOD) – The lowest concentration level that can be determined by a single analysis and with a defined level of confidence to be statistically different from a blank. (ACS)
- 3.26 Limit of Quantitation (LOQ) – The minimum levels, concentrations, or quantities of a target variable (target analyte) that can be reported with a specified degree of confidence. The LOQ is set at 3 to 10 times the LOD, depending on the degree of confidence desired.
- 3.27 Linear Dynamic Range (LDR) – The absolute quantity over which the instrument response to an analyte is linear. This specification is also referred to as the Linear Calibration Range (LCR).
- 3.28 Material Safety Data Sheets (MSDS) – Written information provided by vendors concerning a chemical's toxicity, health hazards, physical properties, fire, and reactivity data including storage, spill, and handling precautions.
- 3.29 May – Denotes permitted action, but not required action. (NELAC)
- 3.30 Method Detection Limit (MDL) – The minimum concentration of an analyte that can be identified, measured, and reported with 99% confidence that the analyte concentration is greater than zero (Standard Methods).
- 3.31 Must – Denotes a requirement that must be met. (Random House College Dictionary)
- 3.32 Photometer – measures the absorbance of the solution in the cell in a multicell cuvette. Light passes from the lamp through the condensing lenses to the interference filter. The plane surface of the first condensing lens is coated with a material which reflects heat and infrared light. The filters are mounted on a filter wheel. There are 15 positions for filters. Each filter corresponds to a wavelength of interest. The 880 nm filter is specified by the test definition for orthophosphate. After passing through the filter the light is converted

into a stream of light pulses by a chopper. Then the light is directed via a quartz fiber through a focusing lens and a slit to the beam divider. The beam divider divides the light into two parts. A specified portion is reflected to the reference detector, which monitors the light level fluctuations. The remaining major portion of the light beam goes through the liquid in the cell to the signal detector, which measures the amount of light absorbed.

- 3.33 Precision – The degree to which a set of observations or measurements of the same property, obtained under similar conditions, conform to themselves; a data quality indicator. Precision is usually expressed as standard deviation, variance or range, in either absolute or relative terms. (NELAC)
- 3.34 Preservation – Refrigeration, freezing, and/or reagents added at the time of sample collection (or later) to maintain the chemical and or biological integrity of the sample.
- 3.35 Quality Control Sample (QCS) – A sample of analyte of known and certified concentration. The QCS is obtained from a source external to the laboratory and different from the source of calibration standards. It is used to check laboratory performance with externally prepared test materials.
- 3.36 Run Cycle – Typically a day of operation – the entire analytical sequence from sampling the first standard to the last sample of the day.
- 3.37 Sample Segment – Bar-coded metal tray that holds up to fourteen four milliliter auto analyzer vials containing samples or standards. The user identifies each vial in the operating software.
- 3.38 Sample Segment Holder – An automated temperature controlled carousel that contains up to six sample segments. This carousel spins in clockwise or counterclockwise manner to move the sample segments into position for analysis. This carousel format allows for continuous processing.
- 3.39 Sensitivity – The capability of a test method or instrument to discriminate between measurement responses representing different levels (concentrations) of a variable of interest.
- 3.40 Shall – Denotes a requirement that is mandatory whenever the criterion for conformance with the specification requires that there be no deviation. (ANSI)
- 3.41 Should – Denotes a guideline or recommendation whenever noncompliance with the specification is permissible. (ANSI)
- 3.42 Standard Reference Material (SRM) – Material which has been certified for specific analytes by a variety of analytical techniques and/or by numerous laboratories using similar analytical techniques. These may consist of pure chemicals, buffers, or compositional standards. The materials are used as an indication of the accuracy of a specific analytical technique.

- 3.43 Test Definition – A photometric test consisting of a user defined testing sequence, reagent additions, calibration standards, incubations and absorption results.
- 3.44 Test Flow – Functions to define the parameter for reagent and sample dispensing, dilution, incubation and measurement.

4 INTERFERENCES

- 4.1 Suspended matter in the sample will scatter light as it passes through the cuvette to the detector. High blank responses will result. The identified sample will be reanalyzed.
- 4.2 Blemishes in the cuvette, as result of the manufacturing process, will result in high blank responses. The identified sample will be reanalyzed.
- 4.3 As much as 50 mg Fe/L, 10 mg Cu/l and 10 mg SiO₂/L can be tolerated. High silica concentrations cause positive interference.

5 SAFETY

- 5.1 Safety precautions must be taken when handling reagents, samples and equipment in the laboratory. Protective clothing including lab coats, safety glasses and enclosed shoes should be worn. In certain situations, it will be necessary to also use gloves and/or a face shield. If solutions come in contact with eyes, flush with water continuously for 15 minutes. If solutions come in contact with skin, wash thoroughly with soap and water. Contact Solomons Rescue Squad (911) if emergency treatment is needed and also inform the CBL Business Manager of the incident. Contact the CBL Business Manager if additional treatment is required.
- 5.2 The toxicity or carcinogenicity of each reagent used in this procedure may not have been fully established. Each chemical should be regarded as a potential health hazard and exposure should be as low as reasonably achievable. Cautions are included for known hazardous materials and procedures.
- 5.3 Do not wear jewelry when troubleshooting electrical components. Even low voltage points are dangerous and can injure if allowed to short circuit.
- 5.4 The following hazard classifications are listed for the chemicals used in this procedure. Detailed information is provided on Material Safety Data Sheets (MSDS).

Chemical	Health	Flammability	Reactivity	Contact	Storage
Sulfuric acid	4	0	2	4	White
Ammonium molybdate	2	0	1	2	Orange
Potassium antimonyl tartrate hemihydrate	3	1	1	2	Blue
Ascorbic Acid	1	1	0	1	Orange
Potassium dihydrogen phosphate	1	0	0	1	Green
Chloroform	3	1	1	3	Blue
Clorox	3	0	2	4	White

On a scale of 0 to 4 the substance is rated on four hazard categories: health, flammability, reactivity, and contact. (0 is non-hazardous and 4 is extremely hazardous)

STORAGE

Red – Flammability Hazard: Store in a flammable liquid storage area.

Blue – Health Hazard: Store in a secure poison area.

Yellow – Reactivity Hazard: Keep separate from flammable and combustible materials.

White – Contact Hazard: Store in a corrosion-proof area.

Green – Use general chemical storage (On older labels, this category was orange).

Striped – Incompatible materials of the same color class have striped labels. These products should not be stored adjacent to substances with the same color label. Proper storage must be individually determined.

6 EQUIPMENT AND SUPPLIES

6.1 Aquakem 250 multi-wavelength automated discrete photometric analyzer.

Aquakem 250 control software operates on a computer running Microsoft Windows NT or XP operating system.

6.2 Freezer, capable of maintaining $-20 \pm 5^\circ \text{C}$.

6.3 Lab ware – All reusable lab ware (glass, Teflon, plastic, etc) should be sufficiently clean for the task objectives. This laboratory cleans all lab ware related to this method with a 10% HCl (v/v) acid rinse. This laboratory cleans all lab ware that has held solutions containing ammonium molybdate with 10% NaOH (w/v) rinse.

7 REAGENTS AND STANDARDS

7.1 Purity of Water – Unless otherwise indicated, references to water shall be understood to mean reagent water conforming to Specification D 1193, Type I. Freshly prepared water should be used for making the standards intended for calibration. The detection limits of this method will be limited by the purity of the water and reagents used to make the standards.

7.2 Purity of Reagents – Reagent grade chemicals shall be used in all tests. Unless otherwise indicated, it is intended that all reagents shall conform to specifications of the Committee on Analytical Reagents of the American Chemical Society, where such specifications are available. Other grades may be used, provided it is first ascertained that the reagent is of sufficiently high purity to permit its use without compromising the accuracy of the determination.

7.3 9.8 N Sulfuric acid

Sulfuric acid (concentrated) 54.4 mL

In a 200 mL volumetric flask add approximately 120 mL deionized water. Add 54.4 mL H_2SO_4 to the deionized water and bring to volume.

Write name of preparer, preparation date, reagent manufacturer, manufacturer's lot number in the Analytical Reagent log book. Store the flask at room temperature. Reagent is stable for one year.

7.4 Ammonium molybdate solution

Ammonium molybdate 8.0 g

In a 100 mL plastic volumetric flask dissolve, with immediate inversion, 8.0 g Ammonium molybdate, in approximately 90 mL deionized water. Bring flask to volume. Store flask in dark at room temperature. Write name of preparer, preparation date, reagent manufacturer, manufacturer's lot number in the Analytical Reagent log book. Reagent is stable for one month. Discard if white precipitate appears in flask or on threads of cap.

7.5 Potassium antimonyl tartrate solution

Potassium antimonyl tartrate 0.6 g

In a 100 mL plastic volumetric flask dissolve 0.6 g Potassium antimonyl tartrate hemihydrate, in approximately 90 mL deionized water. Bring flask to volume. Store flask at room temperature. Write name of preparer, preparation date, reagent manufacturer, manufacturer's lot number in the Analytical Reagent log book. Reagent is stable for one year.

7.6 Ascorbic acid solution

Ascorbic acid 3.6 g

In a 100 mL plastic volumetric flask dissolve 3.6g Ascorbic acid, in approximately 90 mL deionized water. Bring flask to volume. Store flask in refrigerator. Write name of preparer, preparation date, reagent manufacturer, manufacturer's lot number in the Analytical Reagent log book. Reagent is stable for two months.

7.7 Triple Reagent -

9.8 N Sulfuric acid 40 mL

Ammonium molybdate solution 12 mL

Potassium antimonyl tartrate solution 4.0 mL

Add 40 mL 9.8 N Sulfuric acid to a 60 mL reagent container. Carefully add 12 mL Ammonium molybdate solution to the reagent container. Carefully add 4.0 mL Potassium antimonyl tartrate solution to the reagent container. Cap. Invert six times to mix. Write name of preparer, preparation date, constituent solutions' preparation dates in the Analytical Reagent log book. Reagent is stable for two weeks.

7.8 Orthophosphate Stock Standard, 12,000 μM -

Potassium dihydrogen phosphate (KH_2PO_4), primary standard grade, dried at 45°C 1.632 g

In a 1 L volumetric flask, dissolve 1.632 g of potassium dihydrogen phosphate in approximately 800 mL deionized water. Bring flask to volume with deionized water (1 mL contains 12 $\mu\text{moles P}$). Add 1 mL chloroform as a preservative. Write name of preparer, preparation date, standard manufacturer, manufacturer lot number in the Analytical Standard log book. Make fresh every 6 months.

7.9 Secondary Orthophosphate Standard -

Stock Orthophosphate standard 1.0 mL

In a 100 mL volumetric flask, dilute 1.0 mL of Stock Orthophosphate Standard to volume with deionized water to yield a concentration of 120 $\mu\text{M PO}_4\text{-P/L}$ (1 mL contains 1.2 $\mu\text{moles P}$). Write name of preparer,

- preparation date, Stock Standard preparation date in the Analytical Standard log book. Make fresh every month.
- 7.10 Working Regular Orthophosphate Standard –
 Secondary Orthophosphate Standard 1.50 mL
 In a 100 mL volumetric flask, dilute 1.50 mL of Secondary Orthophosphate Standard to volume with deionized water to yield a concentration of 1.8 μM $\text{PO}_4\text{-P/L}$ (0.0558 mg P/L). Write name of preparer, preparation date, Secondary Orthophosphate Standard preparation date in the Analytical Standard log book. Make fresh every month.
- 7.11 Working High Orthophosphate Standard –
 Secondary Orthophosphate Standard 6.00 mL
 In a 100 mL volumetric flask, dilute 6.00 mL of Secondary Orthophosphate Standard to volume with deionized water to yield a concentration of 6.0 μM $\text{PO}_4\text{-P/L}$ (0.186 mg P/L). Write name of preparer, preparation date, Secondary Orthophosphate Standard preparation date in the Analytical Standard log book. Make fresh every month.
- 7.12 Working Extra High Orthophosphate Standard –
 Stock Orthophosphate Standard 0.40 mL
 In a 100 mL volumetric flask, dilute 0.40 mL of Stock Orthophosphate Standard to volume with deionized water to yield a concentration of 48 μM $\text{PO}_4\text{-P/L}$ (1.488 mg P/L). Write name of preparer, preparation date, Stock Orthophosphate Standard preparation date in the Analytical Standard log book. Make fresh every month.
- 7.13 Aquakem Cleaning Solution –
 Clorox 75.0 mL
 In a 100 mL volumetric flask, dilute 75.0 mL of Clorox to volume with deionized water to yield a concentration of 75% Clorox. Write name of preparer, preparation date, reagent manufacturer, manufacturer lot number in the Analytical Reagent log book. Reagent is stable for six months.

8 SAMPLE COLLECTION, PRESERVATION, AND STORAGE

- 8.1 Water collected for orthophosphate should be filtered through a Whatman GF/F glass fiber filter (nominal pore size 0.7 μm), or equivalent.
- 8.2 Water collected for orthophosphate should be frozen at -20°C . The AutoAnalyzer vial container should be clean and sample rinsed.
- 8.3 Frozen orthophosphate samples may be stored up to 28 days. It has been shown that frozen QCS samples up to a year old still fall well within the control limits.
- 8.4 Orthophosphate samples may be refrigerated at 4°C for no longer than one day.

9 QUALITY CONTROL

9.1 The laboratory is required to operate a formal quality control (QC) program. The minimum requirements of this program consist of an initial demonstration of laboratory capability and the continued analysis of laboratory instrument blanks and calibration standard material, analyzed as samples, as a continuing check on performance. The laboratory is required to maintain performance records that define the quality of data generated.

9.2 Initial Demonstration of Performance

- 9.2.1 The initial demonstration of capability (orthophosphate) – is used to characterize instrument performance (MDLs) and laboratory performance (analysis of QC samples) prior to the analyses conducted by this procedure.
- 9.2.2 Linear Dynamic Range – LDR (Linear Calibration Range) should be established for orthophosphate using appropriate seven point calibration curve.
- 9.2.3 Quality Control Sample (QCS/SRM) – When using this procedure, a quality control sample is required to be analyzed at the beginning and end of the run, to verify data quality and acceptable instrument performance. If the determined concentrations are not within $\pm 10\%$ of the certified values, performance of the determinative step of the method is unacceptable. The source of the problem must be identified and corrected before either proceeding with the initial determination of MDLs or continuing with analyses.
- 9.2.4 Method Detection Limits (MDLs) – MDLs should be established for orthophosphate using a low level ambient water sample. To determine the MDL values, analyze seven replicate aliquots of water. Perform all calculations defined in the procedure (Section 12) and report the concentration values in the appropriate units. Calculate the MDL as follows:

$$\text{MDL} = s \times 3$$

Where, s = Standard Deviation of the replicate analyses.

- 9.2.5 MDLs shall be determined yearly and whenever there is a significant change in instrument response, a significant change in instrument configuration, or a new matrix is encountered.

9.3 Assessing Laboratory Performance

- 9.3.1 Laboratory Reagent Blank (LRB) – The laboratory must analyze at least one LRB with each batch of samples. The LRB consists of Nanopure water treated the same as the samples. Analyte found in LRB indicates possible reagent or laboratory environment contamination. LRB data are used to assess and correct contamination

from the laboratory environment. LRB above the lowest standard requires that the source of the problem must be identified and corrected before proceeding with analyses.

- 9.3.2 Quality Control Sample (QCS)/ Standard Reference Material (SRM) – When using this procedure, a quality control sample is required to be analyzed at the beginning of the run and end of the run, to verify data quality and acceptable instrument performance. If the determined concentrations are not within $\pm 3s$ of the certified values, performance of the determinative step of the method is unacceptable. The source of the problem must be identified and corrected before either proceeding with the initial determination of MDLs or continuing with the analyses. The results of these QCS/SRM samples shall be used to determine batch acceptance.
- 9.3.3 The QCS are obtained from a source external to the laboratory and different from the source of calibration standards.
- 9.3.4 Control Charts – The Accuracy Control Chart for QCS/SRM samples is constructed from the average and standard deviation of the 20 most recent QCS/SRM measurements. The accuracy chart includes upper and lower warning levels ($WL=\pm 2s$) and upper and lower control levels ($CL=\pm 3s$). These values are derived from stated values of the QCS/SRM. The standard deviation (s) is specified relative to statistical confidence levels of 95% for WLs and 99% for CLs. Set up an accuracy chart by using percent recovery since the concentration of the QCS/SRM varies. Enter QCS/SRM results on the chart each time the sample is analyzed
- 9.3.5 Continuing Calibration Verification (CCV) – Following every 18-23 samples, one CCV of 1.2 μM $\text{PO}_4\text{-P/L}$ (0.0372 mg P/L) Regular PO_4 , 4 μM $\text{PO}_4\text{-P/L}$ (0.1488 mg P/L) PO_4 HIGH, 36 μM $\text{PO}_4\text{-P/L}$ (1.116 mg P/L) PO_4 XHIGH is analyzed to assess instrument performance. The CCVs are made from the same material as calibration standards (KH_2PO_4), and are to be within $\text{TV} \pm 3s$. Failure to meet the criteria requires correcting the problem, including reanalysis of any affected samples. If not enough sample exists, the data must be qualified if reported.
- 9.3.6 Reagent Blank – The Reagent Blank Control Chart for Reagent Blank samples is constructed from the average and standard deviation of the 20 most recent Reagent Blank measurements. The accuracy chart includes upper and lower warning levels ($WL=\pm 2s$) and upper and lower control levels ($CL=\pm 3s$). The standard deviation (s) is specified relative to statistical confidence levels of 95% for WLs and 99% for CLs. Enter Reagent Blank results on the chart each time the Reagent Blank is analyzed.

9.4 Assessing Analyte Recovery - % Recovery

- 9.4.1 Analyte recovery is assessed through percent recoveries of laboratory spikes of samples.

9.4.2 % Recovery = (Spiked sample concentration – Sample concentration / Concentration of spike solution) X 100

9.5 Assessing Analyte Precision – Relative Percent Difference

9.5.1 Analyte replication is assessed through duplicate analyses of samples – Relative Percent Difference.

9.5.2 $RPD = \frac{\text{Laboratory Duplicate Result 1} - \text{Laboratory Duplicate Result 2}}{[\text{Laboratory Duplicate Result 1} + \text{Laboratory Duplicate Result 2}]/2} \times 100$

9.6 Corrective Actions for Out of Control Data

9.6.1 Control limit – If one measurement exceeds Accuracy Control Chart CL, repeat the analysis immediately. If the repeat measurement is within the CL, continue analyses; if it exceeds the CL, discontinue analyses and correct the problem.

9.6.2 Warning limit – If two out of three successive points exceed Accuracy Control Chart WL, analyze another sample. If the next point is within WL, continue analyses; if the next point exceeds the WL, evaluate potential bias and correct the problem.

9.6.3 Trending – If seven successive Accuracy Control Chart measurements are on the same side of the central line, discontinue analyses and correct the problem.

9.6.4 When external QCS samples are out of control, correct the problem. Reanalyze the samples analyzed between the last in-control measurement and the out-of-control one.

9.6.5 When external CCV samples are out of control, correct the problem. Reanalyze the samples analyzed between the last in-control measurement and the out-of-control one.

9.7 General Operation - To assure optimal operation and analytical results, the Reagent Blank and CCV are tracked daily in the raw data file, copied to Reagent Blank and CCV Control Charts.

10 CALIBRATION AND STANDARDIZATION

10.1 Calibration – Daily calibration must be performed before sample analysis may begin. Seven point calibrations are used with each of the three sub-calibrations that cover the analytical range. Three working orthophosphate standards are used to produce the calibrators for each set of three calibration curves. The instrument performs serial dilutions of working standards to produce the seven calibrators defined for each curve. The following outlines the preparation of the working standards and the following table describes the subsequent serial dilutions the instrument performs to make each standard for each of the three calibration curves.

Orthophosphate Working Standards:

Regular PO4 (PO4CBL2)

Working Standard 0.0558 mg P/L (1.5 mL secondary standard to 100 mL)

Working CCV 0.0372 mg P/L (1.0 mL secondary standard to 100 mL)

PO4HIGH

Working Standard 0.186 mg P/L (6.0 mL secondary standard to 100 mL)

Working CCV 0.1488 mg P/L (4.0 mL secondary standard to 100 mL)

PO4XHIGH

Working Standard 1.488 mg P/L (0.4 mL stock to 100 mL)

Working CCV 1.116 mg P/L (0.3 mL stock to 100 mL)

Orthophosphate Calibrators:

Test Name	Working Standard	Dilution Factor	Concentration mg P/L
PO4CBL2	0.0558 mg P/L	1+15	0.00349
	0.0558 mg P/L	1+9	0.00558
	0.0558 mg P/L	1+6	0.00797
	0.0558 mg P/L	1+4	0.0116
	0.0558 mg P/L	1+2	0.0186
	0.0558 mg P/L	1+1	0.0279
	0.0558 mg P/L	1+0	0.0558
PO4HIGH	0.186 mg P/L	1+10	0.0169
	0.186 mg P/L	1+5	0.0310
	0.186 mg P/L	1+4	0.0372
	0.186 mg P/L	1+3	0.0465
	0.186 mg P/L	1+2	0.062
	0.186 mg P/L	1+1	0.093
	0.186 mg P/L	1+0	0.186
PO4XHIGH	1.488 mg P/L	1+9	0.1488
	1.488 mg P/L	1+4	0.2976
	1.488 mg P/L	1+3	0.372
	1.488 mg P/L	1+2	0.496
	1.488 mg P/L	1+1	0.744
	1.488 mg P/L	1+0	1.488

10.2 The instrument software prepares a standard curve for each set of calibrators. A graph plotting measured absorbance against standard concentration is presented for review and approval. If acceptance criteria are not met the entire curve can be reanalyzed or individual standards can be reanalyzed. One standard value (original or reanalyzed) for each and every standard is incorporated in the curve. The coefficient of determination (Person's r value) for the calibration curve as well as the calculated concentration of each calibrator is reviewed. The calculated value

of each calibrator must be within ten percent of the expected value. The coefficient of determination (Person's r value) for the calibration curve must be greater than 0.980.

11 PROCEDURE – DAILY OPERATIONS QUALITY CONTROL

- 11.1 Turn on computer. Computer will automatically initiate Konelab software. Once software is running, turn on instrument and allow connection between instrument and computer to complete.
- 11.2 Discard any water remaining in the water reservoir from the previous analytical run. Fill the water reservoir with fresh deionized water.
- 11.3 Remove samples from freezer that will be analyzed that day. Allow samples to begin thawing. Begin daily bench sheet documentation.
- 11.4 Once water reservoir is full, “perform washes” – complete five wash cycles and then initiate “start-up” at main menu.
- 11.5 Gather working standards and reagents from refrigerator during startup. Assess standards and reagents. Remake anything that has exceeded the time over which it is considered stable.
- 11.6 Once startup is complete, check that the instrument water blank of water from the reservoir has performed within acceptance limits. If any of the instrument functions are outside their predefined and software controlled limits, the user will be notified on the main menu page. User takes corrective action to return instrument functions to controlled limits.
- 11.7 Load reagents in specified position in reagent carousel and place in refrigerated reagent compartment.
- 11.8 Load working standards in a sample segment, identify the standards in their positions from the drop down menus at the individual segment positions, and load into instrument.
- 11.9 Select the methods to be calibrated. Three methods will be calibrated – PO4CBL2, PO4HIGH and PO4XHIGH are the method names to be selected in the software.
- 11.10 Begin calibration – See test flow below for stepwise instrument functions for the analysis of standards and samples.

Test Flow – Method of Analysis, Stepwise

- 165 µL sample to cuvette with mixing
- Blank response measurement at 880 nm
- 14 µL Triple Reagent to cuvette with mixing
- 7 µL Ascorbic Acid Reagent to cuvette with mixing
- Incubation, 600 seconds, 37°C
- End point absorbance measurement, 880 nm
- Software processes absorbance value, blank response value and uses calibration curve to calculate analyte concentration (mg/L P as PO₄)
- User is notified if any measured values used to calculate final concentration are outside preset limits. If so, analyst has options to accept result, rerun the sample or rerun the sample diluted to a user or software specified factor.

- User is notified of each blank response value. Blank response >0.001 absorbance units indicates a scratched cuvette or turbid sample. If the blank response value exceeds 0.001 absorbance units, the analyst specifies that the sample is reanalyzed. If the blank response value of the reanalyzed sample is <0.001 absorbance units, the reanalyzed result is accepted. If the same concentration and blank response value >0.001 absorbance units is again obtained, the results are accepted.
- 11.11 Organize samples, reagent blanks, check standards and all quality control samples while instrument performs calibrations.
- 11.12 As calibration curves are produced by the instrument, review them for acceptability. The instrument software prepares a standard curve for each set of calibrators. A graph plotting measured absorbance against standard concentration is presented for review and approval. If acceptance criteria are not met, either the entire curve shall be reanalyzed or individual standards shall be reanalyzed, depending on the violation. One standard value (original or reanalyzed) for each and every calibrator is incorporated in the curve.
- 11.13 Once calibration curves are accepted, samples are loaded into the sample segments and loaded into the instrument for analysis. After the Reagent Blank, the first sample analyzed should be an ICV (initial calibration verification) sample. There should be one ICV sample for each calibration curve, of a concentration close to the middle of each range. The following are the usual ICV samples for each curve: 0.0372 mg P/L for PO4CBL2, 0.1488 mg P/L for PO4HIGH and 1.116 mg P/L for PO4XHIGH.
- 11.14 Samples are loaded into the segments and analyzed. CCV (Continuing Calibration Verification) samples (one for each of the three calibration ranges) follow every 18-23 samples. Standard Reference Material (SRM) samples, as well as Laboratory Reagent Blanks (LRB) are scattered throughout the analytical batch. Throughout the analytical batch, samples are chosen as laboratory duplicates and laboratory spikes to assess analyte precision and analyte recovery, respectively. The total number of duplicates and spikes performed will be equal or greater to ten percent of the total number of samples in the analytical batch.
- 11.15 As sample analysis is complete, results must be reviewed and accepted manually. If results fall outside acceptance limits, the sample should be reanalyzed. If sample result exceeds the highest standard of the calibration range it was run within, the samples can be automatically diluted by the instrument and reanalyzed. If the result is such that it will fall within a higher calibration range, it should be reanalyzed in that range. If the result is such that it will fall within a lower calibration range, it should be reanalyzed within that range.
- 11.16 Upon completion of all analysis, results are saved to a daily report file. The file is named by the run date. The daily report file for analytical batch of January 1, 2005 would be named 010105. The file is converted to Microsoft Excel for data work up. Remaining samples are discarded.
- 11.17 All reagents are removed from the reagent chamber and returned to the refrigerator. Reagents that have exceeded their stability period are discarded.

- 11.18 Aquakem Cleaning Solution is inserted into the instrument and shut down procedures are initiated. Daily files are cleared from the instrument software, the software is exited and the instrument is shut down. The computer is shut down.
- 11.19 The waste is flushed down the drain with copious amounts of tap water. The waste cuvette box is moved to the fume hood.

12 DATA ANALYSIS AND CALCULATIONS

- 12.1 Upon completion of all analysis, results are saved to a daily report file. The file is named by the run date. The daily report file for analytical batch of January 1, 2005 would be named 010105. The file is converted to Microsoft Excel for data work up. The instrument software has calculated final sample concentration from the designated standard curve, correcting each concentration for associated blank response and also for any user or instrument specified dilution. Dilution by the instrument is noted by software as analysis ensues and, also, documented in the Excel data report file. The analyst examines each row of data. Results are eliminated that are outside the limits of the calibration range, or have an unrepeated blank response measurement greater than 0.001 absorbance units.

13 METHOD PERFORMANCE

- 13.1 On 30 separate dates from January through July 2008, Reagent Blanks were performed on PO4CBL2 as deionized water analyzed as a sample. This produced a mean value of 0.0016 mg PO₄-P/L, SD 0.00048.
- 13.2 On 30 separate dates from January through July 2008, 30 replicate analyses of SPEX® Corporation QC 6-42 NUT 1 were performed on PO4CBL2. This produced a mean value of 0.135 mg PO₄-P/L, SD 0.0069, Relative Percent Difference of 5.1% from the expected value of 0.131 ± 10%. This is a mean recovery of 103%.
- 13.3 For some estuarine samples analyzed on PO4CBL2 in 2008, the mean difference in concentration between 124 duplicates analyzed on 30 separate dates was 0.00058 mg PO₄-P/L. The standard deviation of the difference between duplicates was 0.00073 PO₄-P/L.

14 REFERENCES

- 14.1 USEPA. 1979. Method No. 365.1 *in* Methods for chemical analysis of water and wastes. United States Environmental Protection Agency, Office of Research and Development. Cincinnati, Ohio. Report No. EPA-600/4-79-020 March 1979. 460pp.
- 14.2 Frank, J. M., C.F. Zimmermann and C. W. Keefe (2006). Comparison of results from Konelab Aquakem 250 and existing nutrient analyzers. UMCES CBL Nutrient Analytical Services Laboratory, Dec. 2006.
- 14.3 Strickland, J.D.H. and T.R. Parsons. 1965. A Manual of Sea Water Analysis, 2nd ed. Fisheries Research Board of Canada, Ottawa.

Determination of Total Dissolved Nitrogen (TDN) in Fresh/Estuarine/Coastal Waters Using Alkaline Persulfate Digestion of Nitrogen to Nitrate and Measured Using Cadmium Reduction

1. SCOPE and APPLICATION

1.1 Potassium Persulfate is used to oxidize organic and inorganic Nitrogen to NO_3 under heated alkaline conditions.

1.2 Cadmium reduction is used to quantitatively reduce dissolved nitrate to nitrite which is then measured by colorimetric quantitative analysis of a highly colored azo dye. The method is used to analyze all ranges of salinity.

1.3 A Method Detection Limit (MDL) of 0.05 mg TDN as $\text{NO}_3\text{-N/L}$ was determined using 3X the standard deviation of 7 replicates.

1.4 The Quantitation Limit for TDN as NO_3 was set at 0.15 mg TDN as $\text{NO}_3\text{-N/L}$.

1.5 This procedure should be used by analysts experienced in the theory and application of aqueous organic and inorganic analysis. Three months experience with an experienced analyst, certified in the analysis of TDN in aqueous samples by cadmium reduction is required.

1.6 This method can be used for all programs that require analysis of TDN.

1.7 This procedure conforms to Standard Methods #4500-N C, 4500- NO_3 F and EPA Method 353.2 (1979).

2. SUMMARY

2.1 An exact amount of filtered samples are placed in test tubes where an exact amount of Potassium Persulfate Digestion Reagent is added. Under initially alkaline conditions and heat, nitrate is the sole nitrogen product.

2.2 The now digested samples are then passed through a granulated copper-cadmium column to reduce nitrate to nitrite. The nitrite, both that which was reduced from nitrate, is then determined by diazotizing with sulfanilamide and coupling with N-1-naphthylethylenediamine dihydrochloride to form a colored azo dye.

3. DEFINITIONS

3.1 Acceptance Criteria – Specified limits placed on characteristics of an item, process, or service defined in a requirement document. (ASQC)

3.2 Accuracy – The degree of agreement between an observed value and an accepted reference value. Accuracy includes a combination of random error (precision) and systematic error (bias) components which are due to sampling and analytical operations; a data quality indicator. (QAMS)

April 13, 2010

- 3.3 Aliquot – A discrete, measured, representative portion of a sample taken for analysis. (EPA QAD Glossary)
- 3.4 Analytical Range – There are multiple analytical ranges/standard curves used for determination of TDN. See Table 1 for all analytical ranges used.
- 3.5 Batch – Environmental samples, which are prepared and /or analyzed together with the same process and personnel, using the same lot(s) of reagents. A **preparation batch** is composed of one to 300 environmental samples of the same matrix, meeting the above mentioned criteria and with a maximum time between the start of processing of the first and last sample in the batch to be 10 hours. An **analytical batch** is composed of prepared environmental samples (extracts, digestates, or concentrates) and/or those samples not requiring preparation, which are analyzed together as a group using the same calibration curve or factor. An analytical batch can include samples originating from various environmental matrices and can exceed 20 samples. (NELAC/EPA)
- 3.6 Blank- A sample that has not been exposed to the analyzed sample stream in order to monitor contamination during sampling, transport, storage or analysis. The blank is subjected to the usual analytical and measurement process to establish a zero baseline or background value and is sometimes used to adjust or correct routine analytical results. (ASQC)
- 3.7 Calibrate- To determine, by measurement or comparison with a standard, the correct value of each scale reading on a meter or other device, or the correct value for each setting of a control knob. The levels of the applied calibration standard should bracket the range of planned or expected sample measurements. (NELAC)
- 3.8 Calibration – The set of operations which establish, under specified conditions, the relationship between values indicated by a measuring device. The levels of the applied calibration standard should bracket the range of planned or expected sample measurements. (NELAC)
- 3.9 Calibration Blank – A volume of reagent water fortified with the same matrix as the calibration standards, without the analyte added.
- 3.10 Calibration Curve – The graphical relationship between known values, such as concentrations, or a series of calibration standards and their analytical response. (NELAC)
- 3.11 Calibration Method – A defined technical procedure for performing a calibration. (NELAC)
- 3.12 Calibration Standard – A substance or reference material used to calibrate an instrument. (QAMS)
- 3.12.1 Initial Calibration Standard (STD) – A series of standard solutions used to initially establish instrument calibration responses and develop calibration curves for individual target analytes.

April 13, 2010

- 3.12.2 Initial Calibration Verification (ICV) – An individual standard, analyzed initially, prior to any sample analysis, which verifies acceptability of the calibration curve or previously established calibration curve.
- 3.12.3 Continuing Calibration Verification (CCV) – An individual standard which is analyzed after every 15-20 field sample analysis.
- 3.13 Certified Reference Material – A reference material one or more of whose property values are certified by a technically valid procedure, accompanied by or traceable to a certificate or other documentation which is issued by a certifying body. (ISO 17025)
- 3.14 Colorimeter – Detector found in Bran & Luebbe Single-Channel Industrial Colorimeter. Color is quantitatively detected with 199-B021-01 phototubes using 550 nm monochromatic filters and 50 mm long flow cell with 1.5 mm internal diameter. Comparisons are made between signals from the colored solution in the flow cell to the signal of air in the reference cell. Signals from the Colorimeter are transmitted to a Recorder.
- 3.15 Corrective Action – Action taken to eliminate the causes of an existing nonconformity, defect or other undesirable situation in order to prevent recurrence. (ISO 8402)
- 3.16 Deficiency – An unauthorized deviation from acceptable procedures or practices. (ASQC)
- 3.17 Demonstration of Capability – A procedure to establish the ability of the analyst to generate acceptable accuracy. (NELAC)
- 3.18 Detection Limit – The lowest concentration or amount of the target analyte that can be determined to be different from zero by a single measurement at a stated degree of confidence.
- 3.19 Duplicate Analysis – The analyses of measurements of the variable of interest performed identically on two sub samples (aliquots) of the same sample. The results from duplicate analyses are used to evaluate analytical or measurement precision but not the precision of sampling, preservation or storage internal to the laboratory. (EPA-QAD)
- 3.20 External Standard (ES) – A pure analyte (potassium nitrate (KN O₃)) that is measured in an experiment separate from the experiment used to measure the analyte(s) in the sample. The signal observed for a known quantity of the pure external standard is used to calibrate the instrument response for the corresponding analyte(s). The instrument response is used to calculate the concentrations of the analyte(s) in the unknown sample.
- 3.21 Field Duplicates (FD1 and FD2) – Two separate samples collected at the same time and place under identical circumstances and treated exactly the same throughout field and laboratory procedures. Analyses of FD1 and FD2 provide a measure of the precision associated with sample collection, preservation and storage, as well as with laboratory procedures.

April 13, 2010

- 3.22 Field Reagent Blank (FRB) – A aliquot of reagent water or other blank matrix that is placed in a sample container in the laboratory and treated as a sample in all respects, including shipment to the sampling site, exposure to the sampling site conditions, storage, preservation, and all analytical procedures. The purpose of the FRB is to determine if method analytes or other interferences are present in the field environment.
- 3.23 Holding time – The maximum time that samples may be held prior to analysis and still be considered valid. (40 CFR Part 136) The time elapsed from the time of sampling to the time of extraction or analysis, as appropriate.
- 3.24 Instrument Detection Limit (IDL) – The minimum quantity of analyte of the concentration equivalent which gives an analyte signal equal to three times the standard deviation of the background signal at the selected wavelength, mass, retention time absorbance line, etc.
- 3.25 Laboratory Duplicates (LD1 and LD2) – Two aliquots of the same sample taken in the laboratory and analyzed separately with identical procedures. Analyses of LD1 and LD2 indicate precision associated with laboratory procedures, but not with sample collection, preservation, or storage procedures.
- 3.26 Laboratory Reagent Blank (LRB) – A blank matrix (i.e., DI water) that is treated exactly as a sample including exposure to all glassware, equipment, solvents, and reagents that are used with other samples. The LRB is used to determine if method analytes or other interferences are present in the laboratory environment, the reagents, or the instrument.
- 3.27 Laboratory Control Sample (LCS) – A sample matrix, free from the analytes of interest, spiked with verified known amounts of analytes from a source independent of the calibration standard or a material containing known and verified amounts of analytes. The LCS is generally used to establish intra-laboratory or analyst-specific precision and bias or to assess the performance of all or a portion of the measurement system. (NELAC)
- 3.28 Limit of Detection (LOD) – The lowest concentration level that can be determined by a single analysis and with a defined level of confidence to be statistically different from a blank. (ACS)
- 3.29 Limit of Quantitation (LOQ) – The minimum levels, concentrations, or quantities of a target variable (target analyte) that can be reported with a specified degree of confidence. The LOQ is set at 3 to 10 times the LOD, depending on the degree of confidence desired.
- 3.30 Linear Dynamic Range (LDR) – The absolute quantity over which the instrument response to an analyte is linear. This specification is also referred to as the Linear Calibration Range (LCR).
- 3.31 Manifold – The module whose configuration of glass connectors, fittings, mixing coils, tubing and Cadmium-Copper reduction column

April 13, 2010

precisely reduces the nitrate in the sample to nitrite, followed by color production.

- 3.32 Material Safety Data Sheets (MSDS) – Written information provided by vendors concerning a chemical’s toxicity, health hazards, physical properties, fire, and reactivity data including storage, spill, and handling precautions.
- 3.33 May – Denotes permitted action, but not required action. (NELAC)
- 3.34 Method Detection Limit (MDL) – The minimum concentration of an analyte that can be identified, measured, and reported with 99% confidence that the analyte concentration is greater than zero.
- 3.35 Must – Denotes a requirement that must be met. (Random House College Dictionary)
- 3.36 Precision – The degree to which a set of observations or measurements of the same property, obtained under similar conditions, conform to themselves; a data quality indicator. Precision is usually expressed as standard deviation, variance or range, in either absolute or relative terms. (NELAC)
- 3.37 Preservation – Refrigeration, freezing, and/or reagents added at the time of sample collection (or later) to maintain the chemical and or biological integrity of the sample.
- 3.38 Proportioning Pump – A peristaltic pump that mixes and advances samples and reagents through proscribed precision pump tubes proportionately for the reactions to take place and for the concentration to be measured.
- 3.39 Quality Control Sample (QCS) – A sample of analyte of known and certified concentration. The QCS is obtained from a source external to the laboratory and different from the source of calibration standards. It is used to check laboratory performance with externally prepared test materials.
- 3.40 Recorder – A graphic recorder used to record electronic output from the colorimeter.
- 3.41 Run Cycle – Typically a day of operation – the entire analytical sequence from sampling the first standard to the last sample of the day.
- 3.42 Sampler – An automated rotational device that moves sample cups sequentially to aspirate an aliquot into the proscribed analytical stream. As the loaded sample tray rotates, a metal probe dips into the sample cup and aspirates sample for a preset time, rises from the sample cup and aspirates air for approximately one second and goes into a deionized water-filled wash receptacle, where deionized water is aspirated. After another preset interval, the probe rises from the wash receptacle, aspirates air and moves into the next sample cup. The sampler moves at a rate of 40 samples per hour with a sample to wash solution ratio of 9:1.

- 3.43 Sensitivity – The capability of a test method or instrument to discriminate between measurement responses representing different levels (concentrations) of a variable of interest.
- 3.44 Shall – Denotes a requirement that is mandatory whenever the criterion for conformance with the specification requires that there be no deviation. (ANSI)
- 3.45 Should – Denotes a guideline or recommendation whenever noncompliance with the specification is permissible. (ANSI)
- 3.46 Standard Reference Material (SRM) – Material which has been certified for specific analytes by a variety of analytical techniques and/or by numerous laboratories using similar analytical techniques. These may consist of pure chemicals, buffers, or compositional standards. The materials are used as an indication of the accuracy of a specific analytical technique.

4 INTERFERENCES

- 4.1 Metals, highly reduced substances, and excessive amounts of nitrogen have the potential of using up potassium persulfate before all nitrogen products have been oxidized.
- 4.2 Suspended matter in the sample will restrict flow through the apparatus. All samples must be filtered. See Section 8.
- 4.3 Concentrations of sulfide, iron, copper or other metals above several milligrams per liter lower reduction efficiency, yielding inaccurate concentrations for those samples and, also, subsequent analyses. Frequent checks of column efficiency and re-analyses of affected samples are necessary.

5 SAFETY

- 5.1 Safety precautions must be taken when handling reagents, samples and equipment in the laboratory. Protective clothing including lab coats, safety glasses and enclosed shoes should be worn. In certain situations, it will be necessary to also use gloves and/or a face shield. If solutions come in contact with eyes, flush with water continuously for 15 minutes. If solutions come in contact with skin, wash thoroughly with soap and water. Contact Solomons Rescue Squad (911) if emergency treatment is needed and also inform the CBL Business Manager of the incident. Contact the CBL Business Manager if additional treatment is required.
- 5.2 The toxicity or carcinogenicity of each reagent used in this procedure may not have been fully established. Each chemical should be regarded as a potential health hazard and exposure should be as low as reasonably achievable. Cautions are included for known hazardous materials and procedures.

April 13, 2010

- 5.3 Do not wear jewelry when troubleshooting electrical components. Even low voltage points are dangerous and can injure if allowed to short circuit.
- 5.4 The following hazard classifications are listed for the chemicals used in this procedure. Detailed information is provided on Material Safety Data Sheets (MSDS).

Chemical	Health	Flammability	Reactivity	Contact	Storage
Sodium Hydroxide	3	0	2	4	White Stripe
Copper Sulfate	2	0	0	2	Green
Ammonium Chloride	2	0	2	2	Green
Sulfanilamide	0	1	1	1	Green
N-1-naphthylethylenediamine dihydrochloride	2	1	1	2	Green
Brij-35	1	0	0	1	Green
Phosphoric Acid	3	0	2	4	White
Hydrochloric Acid	3	0	2	4	White
Acetone	1	4	2	1	Red
Cadmium	3	2	1	4	Red
Potassium nitrate	2	0	3	2	Yellow
Sodium nitrite	2	0	3	2	Yellow
Chloroform	3	1	1	3	Blue
Potassium Persulfate	2	0	1	0	Yellow
Boric Acid	2	0	1	2	Green

On a scale of 0 to 4 the substance is rated on four hazard categories: health, flammability, reactivity, and contact. (0 is non-hazardous and 4 is extremely hazardous)

STORAGE

Red – Flammability Hazard: Store in a flammable liquid storage area.

Blue – Health Hazard: Store in a secure poison area.

Yellow – Reactivity Hazard: Keep separate from flammable and combustible materials.

White – Contact Hazard: Store in a corrosion-proof area.

Green – Use general chemical storage (On older labels, this category was orange).

Striped – Incompatible materials of the same color class have striped labels. These products should not be stored adjacent to substances with the same color label. Proper storage must be individually determined.

6 EQUIPMENT AND SUPPLIES

6.1 Technicon Bran & Luebbe AutoAnalyzer II sampler, proportioning pump, manifold and colorimeter capable of analyzing for nitrate plus nitrite nitrogen are used in this laboratory. A PMC Industries Flat Bed Linear recorder is used to record electronic output from the colorimeter.

6.2 Freezer, capable of maintaining $-20 \pm 5^{\circ} \text{C}$.

April 13, 2010

- 6.3 Lab ware – All reusable lab ware (glass, Teflon, plastic, etc) should be sufficiently clean for the task objectives. This laboratory cleans all lab ware related to this method with a 10% HCl (v/v) acid rinse.
- 6.4 Pressure Cooker with pressure regulator and pressure gauge.
- 6.5 Hot plate with variable heat settings.

7 REAGENTS AND STANDARDS

- 7.1 Purity of Water – Unless otherwise indicated, references to water shall be understood to mean reagent water conforming to Specification D 1193, Type I. Freshly prepared water should be used for making the standards intended for calibration. The detection limits of this method will be limited by the purity of the water and reagents used to make the standards.
- 7.2 Purity of Reagents – Reagent grade chemicals shall be used in all tests. Unless otherwise indicated, it is intended that all reagents shall conform to specifications of the Committee on Analytical Reagents of the American Chemical Society, where such specifications are available. Other grades may be used, provided it is first ascertained that the reagent is of sufficiently high purity to permit its use without compromising the accuracy of the determination.
- 7.3 Alkaline Water –
- | | |
|----------------------------------|---------------|
| Sodium hydroxide (NaOH, pellets) | 0.20±0.02 g |
| Deionized water | up to 1000 mL |
- Add 0.20 g of sodium hydroxide pellets to 1000 mL of deionized water. Write the name of preparer, preparation date, reagent manufacturer, manufacturer lot number in the Analytical Reagent log book. The reagent is stable for six months.
- 7.4 Copper Sulfate Reagent, 2% –
- | | |
|---|--------------|
| Copper sulfate (CuSO ₄ ·5H ₂ O) | 2 g |
| Deionized water | up to 100 ml |
- In a 100 mL volumetric flask, dissolve 2 g of copper sulfate in ~80 mL of deionized water. Dilute to 100 mL with deionized water. Write the name of preparer, preparation date, reagent manufacturer, manufacturer lot number in the Analytical Reagent log book. The reagent is stable for six months.
- 7.5 Ammonium Chloride Reagent –
- | | |
|--|---------------|
| Ammonium Chloride (NH ₄ Cl) | 10 g |
| Alkaline water | up to 1000 mL |
| Copper Sulfate Reagent, 2% | 6 drops |
- In a 1000 ml volumetric flask, dissolve 10 g of concentrated ammonium chloride to ~800 ml of Alkaline Water. Dilute to 1000 mL with Alkaline Water. Attain a pH balance of 8.5. Add 6 drops of Copper Sulfate Reagent, 2%. Write the name of preparer, preparation date, reagent manufacturer, manufacturer lot number in the Analytical Reagent log book. The reagent is stable for six months.
- 7.6 Color Reagent –

April 13, 2010

Sulfanilamide (C ₆ H ₈ N ₂ O ₂ S)	20 g
Phosphoric Acid (H ₃ PO ₄), concentrated (80%)	200 mL
N-1-naphthylethylenediamine dihydrochloride (C ₁₂ H ₁₄ N ₂ ·2HCl)	1 g
Deionized water	up to 2000 mL
Brij-35, 30%	1 mL

In a 2000 mL volumetric flask, add 200 mL concentrated phosphoric acid and 20 g of sulfanilamide to ~1500 mL deionized water. Dissolve completely. Add 1 g of N-1-naphthylethylenediamine dihydrochloride and dissolve. Dilute to 2000 ml with deionized water and add 1 mL of 30% Brij-35. Write the name of preparer, preparation date, reagent manufacturer, manufacturer lot number in the Analytical Reagent log book. Make fresh every 6 weeks. Store at 4°C.

7.7 Nitrate Stock Standard, 5000 µM –

Potassium nitrate (KNO ₃), primary standard grade, dried at 45°C	0.5055 g
Deionized water	up to 1000 mL

In a 1000 mL volumetric flask, dissolve 0.5055 g of potassium nitrate in ~800 mL of deionized water. Dilute to 1000 mL with deionized water (1 mL contains 5 µmoles N). Write the name of preparer, preparation date, reagent manufacturer, manufacturer lot number in the Analytical Standard log book. Make fresh every 4 months or when < 20% remains in bottle.

7.8 Secondary Nitrate Standard –

Stock Nitrate Standard	1.0 mL
Deionized water	up to 100 mL

In a volumetric flask, dilute 1.0 mL of Stock Nitrate Standard to 100 mL with deionized water to yield a concentration of 50 µM NO₃ –N/L (0.70 mg N/L). Write the name of preparer, preparation date, reagent manufacturer, manufacturer lot number in the Analytical Standard log book. Make fresh every 4 weeks.

7.9 Working Nitrate Standard for TDN – See Table 1 for all working Nitrate Standards for TDN.

Write the name of preparer, preparation date, reagent manufacturer, manufacturer lot number in the Analytical Standard log book. Make fresh for every digestion batch.

7.10 Stock Nitrite Standard –

Sodium nitrite (NaNO ₂), primary standard grade, dried at 45°C	0.345 g
Deionized water	up to 1000 mL

In a 1000 mL volumetric flask, dissolve 0.345 g of sodium nitrite in ~800 mL of deionized water. Dilute to 1000 mL with deionized water (1 mL contains 5 μ moles N). Add 1 mL of chloroform as a preservative. Write the name of preparer, preparation date, reagent manufacturer, manufacturer lot number in the Analytical Standard log book. Make fresh every 4 months or when < 20% remains in bottle.

7.11 Secondary Nitrite Standard –	
Stock Nitrite Standard	1.0 mL
Deionized water	up to 100 mL

In a volumetric flask, dilute 1.0 mL of Stock Nitrite Standard to 100 mL with deionized water to yield a concentration of 50 μ M NO₂ –N/L (0.70 mg N/L). Write the name of preparer, preparation date, reagent manufacturer, manufacturer lot number in the Analytical Standard log book. Make fresh every 4 weeks.

7.12 Glutamic Acid Stock Standard, -	
Glutamic Acid dried at 45°C	0.3705 g
Deionized water	up to 500 mL
Chloroform (CHCl ₃)	0.5 mL

In a 500 mL volumetric flask, dissolve 0.3705 g of glutamic acid in about 400 mL of deionized water and dilute to 500 mL with deionized water. Add 0.5 mL of chloroform as a preservative. Write the name of preparer, preparation date, reagent manufacturer, manufacturer lot number in the Analytical Standard log book.

7.13 Working Glutamic Acid Standard for TDN – See Table 1 for all working Glutamic Acid Standards for TDN. Write the name of preparer, preparation date, reagent manufacturer, manufacturer lot number in the Analytical Standard log book. Make fresh for every digestion batch.

7.14 Potassium Persulfate Digestion Reagent –	
Sodium Hydroxide (NaOH)	3 g
Potassium Persulfate (K ₂ S ₂ O ₈), Low N	20.1 g
Deionized water	up to 1000 mL

In a 1000 mL volumetric flask, dissolve 3g of sodium hydroxide and 20.1 g of potassium persulfate in ~800mL of deionized water. Dilute to 1000 mL with deionized water. Write the name of preparer, preparation date, reagent manufacturer, manufacturer lot number in the Analytical Reagent log book. Make fresh daily.

7.15 Borate Buffer Solution –

Boric Acid (H ₃ BO ₃)	61.8 g
Sodium Hydroxide (NaOH)	8 g
Deionized water	up to 1000 mL

In a 1000 mL volumetric flask, dissolve 61.8 g of boric acid in ~ 300mL deionized water. Add 8g of sodium hydroxide and dilute to 1000mL with deionized water. Write the name of preparer, preparation date, reagent manufacturer, manufacturer lot number in the Analytical Reagent log book. Make fresh every 4 months.

8 SAMPLE COLLECTION, PRESERVATION, AND STORAGE

- 8.1 Water collected for TDN should be filtered through a Whatman GF/F glass fiber filter (nominal pore size 0.7 µm), or equivalent.
- 8.2 Prior to initial use, capped 30 mL test tubes must be digested with Digestion Reagent, then rinsed thoroughly with deionized water.
- 8.3 An exact amount (typically 10mL) of sample should be added to each sample rinsed, capped 30mL test tube.
- 8.4 Water collected for TDN should be frozen at -20° C.
- 8.5 Frozen TDN samples may be stored longer than 28 days. It has been shown that frozen QCS samples up to a year old still fall well within the control limits.
- 8.6 Digested TDN samples may be stored up to a year.
- 8.7 TDN samples may be refrigerated at 4° C for no longer than one day.

9 QUALITY CONTROL

- 9.1 The laboratory is required to operate a formal quality control (QC) program. The minimum requirements of this program consist of an initial demonstration of laboratory capability and the continued analysis of laboratory instrument blanks and calibration standard material, analyzed as samples, as a continuing check on performance. The laboratory is required to maintain performance records that define the quality of data generated.
- 9.2 Initial Demonstration of Capability
 - 9.2.1 The initial demonstration of capability (TDN) – is used to characterize instrument performance (MDLs) and laboratory performance (analysis of QC samples) prior to the analyses conducted by this procedure.
 - 9.2.2 Quality Control Sample (QCS/SRM) – When using this procedure, a quality control sample is required to be analyzed during the run, to verify data quality and acceptable instrument performance. If the determined concentrations are not within ± 10% of the certified values, performance of the determinative step of the method is unacceptable. The source of the problem must be identified and corrected before either proceeding with the initial determination of MDLs or continuing with analyses.

April 13, 2010

- 9.2.3 Method Detection Limits (MDLs) – MDLs should be established for TDN using a low level ambient water sample. To determine the MDL values, analyze seven replicate aliquots of water. Perform all calculations defined in the procedure (Section xx) and report the concentration values in the appropriate units. Calculate the MDL as follows:

$$\text{MDL} = s \times 3$$

Where, s = Standard Deviation of the replicate analyses.

- 9.2.4 MDLs shall be determined yearly and whenever there is a significant change in instrument response, a significant change in instrument configuration, or a new matrix is encountered.

9.3 Assessing Laboratory Performance

- 9.3.1 Laboratory Reagent Blank (LRB) – The laboratory must analyze at least one LRB with each batch of samples. The LRB consists of Nanopure water treated the same as the samples. An amount of analyte above the MDL (TDN) found in LRB indicates possible reagent or laboratory environment contamination. LRB data are used to assess and correct contamination from the laboratory environment.
- 9.3.2 Quality Control Sample (QCS)/ Standard Reference Material (SRM) – When using this procedure, a quality control sample is required to be analyzed at the beginning of the run and end of the run, to verify data quality and acceptable instrument performance. If the determined concentrations are not within $\pm 3\sigma$ of the certified values, performance of the determinative step of the method is unacceptable. The source of the problem must be identified and corrected before either proceeding with the initial determination of MDLs or continuing with the analyses. The results of these QCS/SRM samples shall be used to determine sample batch acceptance.
- 9.3.3 The QCS are obtained from a source external to the laboratory and different from the source of calibration standards.
- 9.3.4 Control Charts – The Accuracy Control Chart for QCS/SRM samples is constructed from the average and standard deviation of the 20 most recent QCS/SRM measurements. The accuracy chart includes upper and lower warning levels ($WL = \pm 2s$) and upper and lower control levels ($CL = \pm 3s$). These values are derived from stated values of the QCS/SRM. The standard deviation (s) is specified relative to statistical confidence levels of 95% for WLs and 99% for CLs. Set up an accuracy chart by using percent recovery since the concentration of the QCS/SRM varies. Enter QCS/SRM results on the chart each time the sample is analyzed.
- 9.3.5 Continuing Calibration Verification (CCV) – Following every 18-23 samples, two CCV are analyzed to assess instrument performance.

April 13, 2010

The CCVs are made from the different material than the calibration standards (KNO_3), and are to be within $\text{TV} \pm 3\sigma$. Failure to meet the criteria requires correcting the problem, including reanalysis of any affected samples. If not enough sample exists, the data must be qualified if reported. Specific CCV's can be found in Table 1.

9.4 Assessing Analyte Recovery - % Recovery

9.4.1 Analyte recovery is assessed through percent recoveries of laboratory spikes. Analyte recovery is also assessed through the percent recovery of an organic standard that was digested with each batch of samples.

9.4.2 $\% \text{ Recovery} = (\text{Spiked sample concentration} - \text{Sample concentration} / \text{Concentration of spike solution}) \times 100$

9.5 Assessing Analyte Precision – Relative Percent Difference (RPD)

9.5.1 Analyte replication is assessed through duplicate analyses of samples – Relative Percent Difference.

9.5.2 $\text{RPD} = (\text{Laboratory Duplicate Result 1} - \text{Laboratory Duplicate Result 2}) / [(\text{Laboratory Duplicate Result 1} + \text{Laboratory Duplicate Result 2}) / 2] \times 100$

9.6 Corrective Actions for Out of Control Data

9.6.1 Control limit – If one measurement exceeds Accuracy Control Chart CL, repeat the analysis immediately. If the repeat measurement is within the CL, continue analyses; if it exceeds the CL, discontinue analyses and correct the problem.

9.6.2 Warning limit – If two out of three successive points exceed Accuracy Control Chart WL, analyze another sample. If the next point is within WL, continue analyses; if the next point exceeds the WL, evaluate potential bias and correct the problem.

9.6.3 Trending – If seven successive Accuracy Control Chart measurements are on the same side of the central line, discontinue analyses and correct the problem.

9.6.4 When external QCS samples are out of control, correct the problem. Reanalyze the samples analyzed between the last in-control measurement and the out-of-control one.

9.6.5 When external CCV samples are out of control, correct the problem. Reanalyze the samples analyzed between the last in-control measurement and the out-of-control one.

9.7 General Operation - To assure optimal operation and analytical results, the Reagent Blank (LRB) and CCV are tracked daily in the raw data file, copied to Reagent Blank (LRB) and CCV Control Charts.

10 CALIBRATION AND STANDARDIZATION

April 13, 2010

- 10.1 Calibration – Daily calibration must be performed before sample analysis may begin. Four point calibrations are used with the Technicon Bran & Luebbe AutoAnalyzer II in replicates of three. ASTM Type I water is used as the “zero point” in the calibration.
- 10.2 Working TDN Standards – See Table 1 for all working TDN Standards.
- 10.3 Prepare standard curve by plotting response on recorder of standards processed through the manifold against TDN as NO_3^- concentration in standards.
- 10.4 Compute sample mg TDN/L concentration by comparing sample response on recorder with standard curve.

11 PROCEDURE – NEW REDUCTION COLUMN PREPARATION

- 11.1 Prepare Copper-Cadmium Column – Use good quality cadmium filings of 25-60 mesh size.
- 11.2 Clean 10 g of cadmium with 20 mL of acetone. Rinse twice with 20 mL of deionized water. Next, clean cadmium with 50 mL of 1 N Hydrochloric Acid for 1 minute. Cadmium turns silver in color. Decant Hydrochloric Acid and wash the cadmium with another 50 mL of 1 N Hydrochloric Acid for 1 minute.
- 11.3 Decant 1 N Hydrochloric Acid and wash the cadmium several times with deionized water.
- 11.4 Decant deionized water and add 20 mL of 2% (w/v) Copper Sulfate ($\text{CuSO}_4 \cdot 5\text{H}_2\text{O}$). Wash the cadmium until no blue color remains in the solution.
- 11.5 Decant Copper Sulfate solution and add another 20 mL of 2% (w/v) Copper Sulfate ($\text{CuSO}_4 \cdot 5\text{H}_2\text{O}$). Wash the cadmium until no blue color remains in the solution. The cadmium will be dark brown in color.
- 11.6 Decant Copper Sulfate solution and wash thoroughly (~10 times) with deionized water.
- 11.7 Set up Manifold, following general procedure of the manufacturer in the following described order.
- 11.8 Insert a glass wool plug at the outlet end of the column. Fill the reductor column tubing (22 cm length of 0.110-inch ID Tygon tubing) with Ammonium Chloride Reagent and transfer the prepared cadmium granules to the column using a Pasteur pipette or some other method that prevents contact of cadmium granules with air. Do not allow any air bubbles to be trapped in column. Pack entire column uniformly with filings such that, visually, the packed filings have separation gaps $\leq \sim 1\text{mm}$.
- 11.9 Ammonium Chloride Reagent initiates analytical sample stream from 1.40 mL/min Yellow/Blue pump tube.
- 11.10 Air is injected from 0.32 mL/min Black/Black pump tube.
- 11.11 Sample is added from 0.16 mL/min Orange/Yellow pump tube.
- 11.12 Mixing occurs in five turn coil.
- 11.13 Air bubbles are de-bubbled from analytical sample stream using 0.60 mL/min Red/Red pump tube.

April 13, 2010

- 11.14 De-bubbled analytical sample stream passes through 22 cm reductor column.
- 11.15 Air is injected from 0.32 mL/min Black/Black pump tube.
- 11.16 Color Reagent is added from 0.32 mL/min Black/Black pump tube.
- 11.17 Mixing occurs in twenty-two turn coil.
- 11.18 Analytical sample stream enters 1.5 mm ID, 50 mm long Flow Cell pulled by 0.80 mL/min waste line. Bubbles and remainder of sample stream exit by gravity.
- 11.19 Color of analytical sample stream is quantitatively read at 550 nm by Colorimeter with 199-B021-01 Phototube, electronic output recorded on strip chart of Recorder.
- 11.20 Attach pump tubes to end rails of Proportioning Pump. Put platen on Proportioning Pump. With deionized water running through the sample line and Ammonium Chloride Reagent running through its designated line, attach the column. Make sure there are no air bubbles in the valve and attach the column to the intake side of the valve first. Open the valve to allow Ammonium Chloride Reagent Stream to flow through the column. Allow deionized water to run through the Color Reagent line.
- 11.21 Turn on Colorimeter and Recorder.
- 11.22 Check for good flow characteristics (good bubble pattern) after insertion of air bubbles beyond the column. If the column is packed too tightly, an inconsistent flow pattern will result. Allow Ammonium Chloride Reagent to flow through Column, manifold and Colorimeter for one hour.
- 11.23 At conclusion of that hour, condition the column with approximately 100 mg N/L (KNO_3) for 5 minutes, followed by approximately 100 mg N/L (NaNO_2) for 5 minutes. Turn Baseline Knob on Colorimeter to obtain 0 deflection on Recorder.
- 11.24 Attach Color Reagent line to Color Reagent. At Colorimeter Standard Calibration setting of 1.00, note deflection on Recorder. Reject Color Reagent if deflection is more than 8 out of total 100 chart units. Turn Baseline Knob on Colorimeter to obtain 0 deflection on Recorder.
- 11.25 At Colorimeter Standard Calibration setting of 1.50, analyze Secondary Nitrate Standard ($50 \mu\text{M NO}_3^-$ -N/L (0.70 mg N/L)) and Secondary Nitrite Standard ($50 \mu\text{M NO}_2^-$ -N/L (0.70 mg N/L)). If peak height of Secondary Nitrate Standard is <90% of peak height of Secondary Nitrite Standard, prepare a new cadmium reduction column.
- 11.26 Analyze Inorganic Nitrate Standards for column assessment. (See Table 1 and use the same standards as used for Inorganic Linearity Check.)
- 11.27 Prepare standard curve by plotting response on recorder of standards processed through the manifold against NO_3 -N/L concentration in standards.
- 11.28 At the end of the run, allow deionized water to flow through the sample line for 10 minutes. Close the valve to the column, diverting flow. Allow deionized water to flow through sample, Ammonium Chloride and Color Reagent lines for one minute. Turn Proportioning Pump switch to fast pump for its allotted time.

April 13, 2010

- 11.29 Turn off Sampler, Colorimeter and Recorder. Release and remove Proportioning Pump platen. Release pump tube holders from end rails.

12 PROCEDURE – DAILY OPERATION

- 12.1 Attach pump tubes to end rails of Proportioning Pump. Put platen on Proportioning Pump. Allow deionized water to run through the sample line, Ammonium Chloride Reagent to run through its line and deionized water to run through the Color Reagent line. Check for good flow characteristics (good bubble pattern).
- 12.2 Turn on Colorimeter and Recorder. Set Colorimeter Standard Calibration setting to 1.00. Let liquid pump through the Manifold and Colorimeter for 15 minutes.
- 12.3 At the conclusion of the 15 minutes, turn Baseline Knob on Colorimeter to obtain 5 chart units deflection on Recorder.
- 12.4 Attach Color Reagent line to the Color Reagent. Open the valve to allow liquid to allow Ammonium Chloride Reagent Stream to flow through the column. At a Colorimeter Standard Calibration setting of 1.00, note deflection on the Recorder. Reject Color Reagent if deflection is more than 8 out of total 100 chart units. Turn Baseline Knob on the Colorimeter to obtain 0 deflection on Recorder.
- 12.5 At desired Standard Calibration (See Table 1), analyze inorganic linearity check also listed in Table 1. Repeat the top standard to check for good replication. If replicates are not within $\pm 10\%$, repack the column and repeat. If repeating fails a second time, prepare a new cadmium reduction column. If the peak height of Secondary Nitrate Standard is $<90\%$ of the peak height of Secondary Nitrite Standard, prepare a new cadmium reduction column.
- 12.6 Analyze Working TDN Standards using the NAP Software Program. (For NAP Software Program procedures, see Appendix A.) The NAP Software Program will prepare standard curve by plotting response on recorder of standards processed through the manifold against TDN as $\text{NO}_3\text{-N/L}$ concentration in standards.
- 12.7 Analyze samples. The NAP Software Program will compute sample TDN as $\text{NO}_3\text{-mg N/L}$ concentration by comparing sample response on Recorder with standard curve.
- 12.8 Change the Standard Calibration if a sample peak is larger than 100%. Standard Calibration of 1.5 and 2.0 can both be turned down to 1.0. Calculate the Change in Gain by multiplying the peak height times $100/79.9$ for correcting to a Standard Calibration of 1.5 and $100/68.0$ for correcting to a Standard Calibration of 2.0. This will give a corrected peak height. Use the corrected peak height with the daily regression in order to calculate the sample concentration in mg/L.
- 12.9 At the end of the run, analyze Secondary Nitrate Standard ($50\ \mu\text{M NO}_3\text{-N/L}$ ($0.70\ \text{mg N/L}$)) and Secondary Nitrite Standard ($50\ \mu\text{M NO}_2\text{-N/L}$ ($0.70\ \text{mg N/L}$)). If the peak height of Secondary Nitrate Standard is $<90\%$ of the

April 13, 2010

- peak height of Secondary Nitrite Standard, reject all sample concentrations and prepare a new cadmium reduction column.
- 12.10 Allow deionized water to flow through the sample line for 10 minutes. Close the valve to the column, diverting flow. Allow deionized water to flow through the sample, Ammonium Chloride and Color Reagent lines for one minute. Turn Proportioning Pump switch to fast pump for its allotted time.
 - 12.11 Turn off Sampler, Colorimeter and Recorder. Release and remove Proportioning Pump platen. Release pump tubes from end rails.

13 PROCEDURE – SAMPLE DIGESTION

- 13.1 TDN/TDP samples are digested simultaneously in the same ampule. In our procedures, this ampule is a 30 mL screw cap test tube.
- 13.2 Prepare working standards, QCS, and CCV in labeled 100 mL volumetric flasks:
 - 13.2.1 Select concentration range for both TDN/TDP that best fits the sample batch from Table 1.
 - 13.2.2 Fill 100 mL volumetric flasks with 80 mL deionized water.
 - 13.2.3 Add appropriate amount of KNO_3 and KH_2PO_4 to each labeled working standard volumetric flask from Table 1.
 - 13.2.4 Add appropriate amount of glutamic/glycerophosphate to each labeled CCV and % recovery volumetric flask from Table 1.
 - 13.2.5 Bring up to 100 mL volume with deionized water.
 - 13.2.6 Mix each 100 mL labeled volumetric flask thoroughly
- 13.3 Sub-sample working standards into 30mL screw cap test tubes:
 - 13.3.1 Prepare 3, 30mL labeled test tubes for each working standard concentration.
 - 13.3.2 Sample rinse each test tube with the appropriate working standard.
 - 13.3.3 Add exactly 10mL of each working standard to each test tube.
 - 13.3.4 Prepare 3 labeled test tubes with exactly 10 mL deionized water for “0” in the calibration curve.
 - 13.3.5 Set aside 3 empty labeled test tubes to be digested with the batch with digestion reagent only.
 - 13.3.6 Prepare 2, 30mL labeled test tubes for glutamic/glycerophosphate for % recovery by adding exactly 10mL to each test tube.
 - 13.3.7 Prepare 2, 30mL labeled test tubes for glutamic/glycerophosphate for CCV by adding exactly 10mL of the designated CCV solution to each test tube.
 - 13.3.8 Thaw a Quality Control Sample (Spex) sample stored in freezer and sub-sample exactly 10mL into a labeled 30mL test tube to be used for QCS.

April 13, 2010

- 13.4 Prepare Digestion Reagent by dissolving 20.1 g Potassium persulfate and 3 g Sodium hydroxide in a 1000 mL volumetric flask:
 - 13.4.1 Rinse volumetric flask with deionized water.
 - 13.4.2 Add 20.1 g Potassium persulfate directly to the volumetric flask.
 - 13.4.3 Add deionized water until the meniscus is slightly below full volume.
 - 13.4.4 Add 3 g Sodium Hydroxide to the persulfate and water solution, cap immediately and mix thoroughly.
 - 13.4.5 Bring to volume with deionized water.
 - 13.4.6 Make fresh daily.
 - 13.4.7 Digestion Reagent has a shelf life of about 4 hours.
- 13.5 When ready to digest, thaw frozen samples at room temperature.
- 13.6 Rinse dispensing vessel with deionized water and sample rinse with digestion reagent.
- 13.7 Add thoroughly mixed digestion reagent.
- 13.8 Check dispensing vessel for desired dispensing amount.
- 13.9 Add desired amount of digestion reagent, cap tube, shake for mixing and add test tube to pressure cooker.
- 13.10 Add desired amount of digestion reagent to the standards at the beginning, middle and end of the sequence of loading the samples.
- 13.11 When all samples and standards have received digestion reagent and have been loaded into the pressure cooker, place pressure cooker on hot plate, add deionized water until tubes are 75% immersed, wet the gasket on the lid with a few drops of water and place lid on the pressure cooker.
- 13.12 Turn the hot plate on maximum temperature and have the pressure cooker come up to full steam. (This takes about 1 hour.)
- 13.13 When full steam is achieved, place the pressure regulator on the steam vent. Maintain heat for the cooker containing samples and standards at 3-4 psi for 1 hour.
- 13.14 Turn off pressure cooker and unplug the hot plate when finished. Keep the lid on the pressure cooker.
- 13.15 After samples have cooled, usually the next day, remove the pressure cooker lid, add 1 mL Borate Buffer to each tube, cap, and shake.
- 13.16 Sample batch is now ready to analyze and is stable for 1 year.

14 DATA ANALYSIS AND CALCULATIONS

- 14.1 Upon completion of all analysis, results are saved to a Lotus 123 daily report file. The file is named by the run date. The daily report file for analytical batch of January 1, 2005 would be named 010105tdnp. The instrument software has calculated final sample concentration from the designated standard curve in a program called New Analyzer Program (NAP) Software. Dilution by the analyst is noted and recalculated by multiplying the original peak height times the dilution factor to calculate a corrected peak height. Use the corrected peak height with the daily regression to calculate

April 13, 2010

the sample concentration in mg/L. The analyst examines each peak height and peak marker within the NAP Software and compares it to the peak height from the chart recorder. Results are eliminated that are outside the limits of the calibration range.

15 METHOD PERFORMANCE

- 15.1 On 27 separate dates from February through July 2008, 27 replicate analyses of SPEX® Corporation QC 6-42 NUT 1 were performed by TDN Cadmium Reduction. This produced a mean value of 0.73 mg TDN as NO₃-N/L, SD 0.032, Relative Percent Difference of 13.2% from the expected value of 0.65 ± 10%. This is a mean recovery of 113%.

16 REFERENCES

- 16.1 Technicon Industrial Method No. 158-71 W/A Tentative. 1977. Technicon Industrial Systems. Tarrytown, New York, 10591.
- 16.2 USEPA. 1979. Method No. 353.2 *in* Methods for chemical analysis of water and wastes. United States Environmental Protection Agency, Office of Research and Development. Cincinnati, Ohio. Report No. EPA-600/4-79-020 March 1979. 460pp.

April 13, 2010

Range	Pump Tubes	umoles NO3/L	mg N/L	ml 1 NO3 std/100ml	Spike Conc.	Inorganic Check For Linearity	Glutamic/Glycerphosphate for % Recovery	Nap File Created	CCV	Correction Coefficient
		0	0	DI H2O						
Low	Orn/Yel sample	25	0.35	0.5	200 umole NO3	50 NO3	1 ml Glutamic	Low TDN (group)	0.5 mL Glutamic	50 umoles
10 ml sample	Yel/Blu NH4Cl	50	0.70	1.0	12 umole PO4	50 NO2		lown2 (samp. table)	0.31 mgN/L	NO3
5 ml persulfate	Std Cal. 1.5	75	1.05	1.5		35 NO3 10 NO3 3.5 NO3				
		0	0	DI H2O						
High	Orn/Grn sample	25	0.35	0.5	200 umole NO3	75 NO3	1 ml Glutamic	High TDN (group)	0.5 mL Glutamic	75 umoles
10 ml sample	Yel/Blu NH4Cl	50	0.70	1.0	12 umole PO4	50 NO3		lown2 (samp. table)	0.31 mgN/L	NO3
5 ml persulfate	Std Cal. 1.5	100	1.40	2.0		50 NO2 35 NO3 10 NO3				
		0	0	DI H2O						
XHigh	Orn/Wht sample	50	0.70	1.0	400 umole NO3	100 NO3	2 ml Glutamic	XHigh TDN (group)	1.0 mL Glutamic	100 umoles
10 ml sample	Yel/Yel NH4Cl	100	1.40	2.0	12 umole PO4	50 NO3		Xhigh TDN (samp. table)	0.72 mgN/L	NO3
5 ml persulfate	Yel/Yel DI Blk/Blk resample Std Cal 2.0	200	2.80	4.0		50 NO2 35 NO3 10 NO3				
		0	0	DI H2O						
TWS TDN	Blk/Blk sample	150	2.1	3.0	2.5 ml of	100 NO3	4 ml Glutamic	TWS TDN (group)	4 ml Glutamic	100 umoles
5 ml sample	Yel/Yel NH4Cl	300	4.2	6.0	400 umole NO3 &	50 NO3		TWS TDN (samp. table)	2.88 mgN/L	NO3
15 ml persulfate	Yel/Yel DI Blk/Blk resample Std Cal 2.0	400	5.6	8.0	12 umole PO4 Added to 2.5 ml sample prior to digestion	50 NO2 35 NO3 10 NO3				

Table 1. Methods and Standards Used for TDN Cadmium Reduction

April 13, 2010

April 13, 2010

Determination of Total Dissolved Phosphorus (TDP) in Fresh/Estuarine/Coastal Waters Using Alkaline Persulfate Digestion of Phosphorus to Orthophosphate (PO₄)

1. SCOPE and APPLICATION

1.1 Potassium Persulfate is used to oxidize organic and inorganic Phosphorus to orthophosphate under heated acidic conditions.

1.2 Ammonium molybdate and potassium antimony tartrate react in an acid medium with dilute solutions of orthophosphate to form an antimony-phosphomolybdate complex which is reduced to an intensely blue-colored complex by ascorbic acid. Color is proportional to orthophosphate concentration. The method is used to analyze all ranges of salinity.

1.3 A Method Detection Limit (MDL) of 0.0015 mg TDP as PO₄-P/L was determined using 3X the standard deviation of 7 replicates.

1.4 The Quantitation Limit for TDP as PO₄ was set at 0.0045 mg TDP as PO₄-P/L.

1.5 This procedure should be used by analysts experienced in the theory and application of aqueous organic and inorganic analysis. Three months experience with an experienced analyst, certified in the analysis of TDP in aqueous samples is required.

1.6 This method can be used for all programs that require analysis of TDP.

1.7 This procedure conforms to Standard Methods #4500-P.B.5, #4500 P.E, and EPA Method 365.1 (1979).

2. SUMMARY

2.1 An exact amount of filtered samples are placed in test tubes where an exact amount of Potassium Persulfate Digestion Reagent is added. Under initially alkaline conditions and heat, nitrate is the sole nitrogen product. After the Potassium Persulfate is used up, conditions become acidic and orthophosphate becomes the sole phosphorus product.

2.2 The now digested samples are mixed with a sulfuric acid-molybdate solution, and subsequently with an ascorbic acid solution, yielding an intense blue color suitable for photometric measurement.

3. DEFINITIONS

3.1 Acceptance Criteria – Specified limits placed on characteristics of an item, process, or service defined in a requirement document. (ASQC)

3.2 Accuracy – The degree of agreement between an observed value and an accepted reference value. Accuracy includes a combination of random error (precision) and systematic error (bias) components which are due to sampling and analytical operations; a data quality indicator. (QAMS)

April 13, 2010

- 3.3 Aliquot – A discrete, measured, representative portion of a sample taken for analysis. (EPA QAD Glossary)
- 3.4 Analytical Range – There are multiple analytical ranges/standard curves used for determination of TDP. See Table 1 for all analytical ranges used.
- 3.5 Batch – Environmental samples, which are prepared and /or analyzed together with the same process and personnel, using the same lot(s) of reagents. A **preparation batch** is composed of one to 300 environmental samples of the same matrix, meeting the above mentioned criteria and with a maximum time between the start of processing of the first and last sample in the batch to be 10 hours. An **analytical batch** is composed of prepared environmental samples (extracts, digestates, or concentrates) and/or those samples not requiring preparation, which are analyzed together as a group using the same calibration curve or factor. An analytical batch can include samples originating from various environmental matrices and can exceed 20 samples. (NELAC/EPA)
- 3.6 Blank- A sample that has not been exposed to the analyzed sample stream in order to monitor contamination during sampling, transport, storage or analysis. The blank is subjected to the usual analytical and measurement process to establish a zero baseline or background value and is sometimes used to adjust or correct routine analytical results. (ASQC)
- 3.7 Calibrate- To determine, by measurement or comparison with a standard, the correct value of each scale reading on a meter or other device, or the correct value for each setting of a control knob. The levels of the applied calibration standard should bracket the range of planned or expected sample measurements. (NELAC)
- 3.8 Calibration – The set of operations which establish, under specified conditions, the relationship between values indicated by a measuring device. The levels of the applied calibration standard should bracket the range of planned or expected sample measurements. (NELAC)
- 3.9 Calibration Blank – A volume of reagent water fortified with the same matrix as the calibration standards, without the analyte added.
- 3.10 Calibration Curve – The graphical relationship between known values, such as concentrations, or a series of calibration standards and their analytical response. (NELAC)
- 3.11 Calibration Method – A defined technical procedure for performing a calibration. (NELAC)
- 3.12 Calibration Standard – A substance or reference material used to calibrate an instrument. (QAMS)
- 3.12.1 Initial Calibration Standard (STD) – A series of standard solutions used to initially establish instrument calibration responses and develop calibration curves for individual target analytes.

- 3.12.2 Initial Calibration Verification (ICV) – An individual standard, analyzed initially, prior to any sample analysis, which verifies acceptability of the calibration curve or previously established calibration curve.
- 3.12.3 Continuing Calibration Verification (CCV) – An individual standard which is analyzed after every 15-20 field sample analysis.
- 3.13 Certified Reference Material – A reference material one or more of whose property values are certified by a technically valid procedure, accompanied by or traceable to a certificate or other documentation which is issued by a certifying body. (ISO 17025)
- 3.14 Colorimeter – Detector found in Bran & Luebbe Single-Channel Industrial Colorimeter. Color is quantitatively detected with 199-B021-04 phototubes using 880 nm monochromatic filters and 50 mm long flow cell with 1.5 mm internal diameter. Comparisons are made between signals from the colored solution in the flow cell to the signal of air in the reference cell. Signals from the Colorimeter are transmitted to a Recorder.
- 3.15 Corrective Action – Action taken to eliminate the causes of an existing nonconformity, defect or other undesirable situation in order to prevent recurrence. (ISO 8402)
- 3.16 Deficiency – An unauthorized deviation from acceptable procedures or practices. (ASQC)
- 3.17 Demonstration of Capability – A procedure to establish the ability of the analyst to generate acceptable accuracy. (NELAC)
- 3.18 Detection Limit – The lowest concentration or amount of the target analyte that can be determined to be different from zero by a single measurement at a stated degree of confidence.
- 3.19 Duplicate Analysis – The analyses of measurements of the variable of interest performed identically on two sub samples (aliquots) of the same sample. The results from duplicate analyses are used to evaluate analytical or measurement precision but not the precision of sampling, preservation or storage internal to the laboratory. (EPA-QAD)
- 3.20 External Standard (ES) – A pure analyte (potassium phosphate (KH_2PO_4)) that is measured in an experiment separate from the experiment used to measure the analyte(s) in the sample. The signal observed for a known quantity of the pure external standard is used to calibrate the instrument response for the corresponding analyte(s). The instrument response is used to calculate the concentrations of the analyte(s) in the unknown sample.
- 3.21 Field Duplicates (FD1 and FD2) – Two separate samples collected at the same time and place under identical circumstances and treated exactly the same throughout field and laboratory procedures. Analyses of FD1 and FD2 provide a measure of the precision associated with sample collection, preservation and storage, as well as with laboratory procedures.

April 13, 2010

- 3.22 Field Reagent Blank (FRB) – An aliquot of reagent water or other blank matrix that is placed in a sample container in the laboratory and treated as a sample in all respects, including shipment to the sampling site, exposure to the sampling site conditions, storage, preservation, and all analytical procedures. The purpose of the FRB is to determine if method analytes or other interferences are present in the field environment.
- 3.23 Holding time – The maximum time that samples may be held prior to analysis and still be considered valid. (40 CFR Part 136) The time elapsed from the time of sampling to the time of extraction or analysis, as appropriate.
- 3.24 Instrument Detection Limit (IDL) – The minimum quantity of analyte of the concentration equivalent which gives an analyte signal equal to three times the standard deviation of the background signal at the selected wavelength, mass, retention time absorbance line, etc.
- 3.25 Laboratory Duplicates (LD1 and LD2) – Two aliquots of the same sample taken in the laboratory and analyzed separately with identical procedures. Analyses of LD1 and LD2 indicate precision associated with laboratory procedures, but not with sample collection, preservation, or storage procedures.
- 3.26 Laboratory Reagent Blank (LRB) – A blank matrix (i.e., DI water) that is treated exactly as a sample including exposure to all glassware, equipment, solvents, and reagents that are used with other samples. The LRB is used to determine if method analytes or other interferences are present in the laboratory environment, the reagents, or the instrument.
- 3.27 Laboratory Control Sample (LCS) – A sample matrix, free from the analytes of interest, spiked with verified known amounts of analytes from a source independent of the calibration standard or a material containing known and verified amounts of analytes. The LCS is generally used to establish intra-laboratory or analyst-specific precision and bias or to assess the performance of all or a portion of the measurement system. (NELAC)
- 3.28 Limit of Detection (LOD) – The lowest concentration level that can be determined by a single analysis and with a defined level of confidence to be statistically different from a blank. (ACS)
- 3.29 Limit of Quantitation (LOQ) – The minimum levels, concentrations, or quantities of a target variable (target analyte) that can be reported with a specified degree of confidence. The LOQ is set at 3 to 10 times the LOD, depending on the degree of confidence desired.
- 3.30 Linear Dynamic Range (LDR) – The absolute quantity over which the instrument response to an analyte is linear. This specification is also referred to as the Linear Calibration Range (LCR).
- 3.31 Manifold – The module whose configuration of glass connectors, fittings, mixing coils, tubing and 37° C heating bath precisely reduces

April 13, 2010

- the antimony-phospho-molybdate complex to an intensely blue-colored complex by ascorbic acid to orthophosphate.
- 3.32 Material Safety Data Sheets (MSDS) – Written information provided by vendors concerning a chemical’s toxicity, health hazards, physical properties, fire, and reactivity data including storage, spill, and handling precautions.
- 3.33 May – Denotes permitted action, but not required action. (NELAC)
- 3.34 Method Detection Limit (MDL) – The minimum concentration of an analyte that can be identified, measured, and reported with 99% confidence that the analyte concentration is greater than zero.
- 3.35 Must – Denotes a requirement that must be met. (Random House College Dictionary)
- 3.36 Precision – The degree to which a set of observations or measurements of the same property, obtained under similar conditions, conform to themselves; a data quality indicator. Precision is usually expressed as standard deviation, variance or range, in either absolute or relative terms. (NELAC)
- 3.37 Preservation – Refrigeration, freezing, and/or reagents added at the time of sample collection (or later) to maintain the chemical and or biological integrity of the sample.
- 3.38 Proportioning Pump – A peristaltic pump that mixes and advances samples and reagents through proscribed precision pump tubes proportionately for the reactions to take place and for the concentration to be measured.
- 3.39 Quality Control Sample (QCS) – A sample of analyte of known and certified concentration. The QCS is obtained from a source external to the laboratory and different from the source of calibration standards. It is used to check laboratory performance with externally prepared test materials.
- 3.40 Recorder – A graphic recorder used to record electronic output from the colorimeter.
- 3.41 Run Cycle – Typically a day of operation – the entire analytical sequence from sampling the first standard to the last sample of the day.
- 3.42 Sampler – An automated rotational device that moves sample cups sequentially to aspirate an aliquot into the proscribed analytical stream. As the loaded sample tray rotates, a metal probe dips into the sample cup and aspirates sample for a preset time, rises from the sample cup and aspirates air for approximately one second and goes into a deionized water-filled wash receptacle, where deionized water is aspirated. After another preset interval, the probe rises from the wash receptacle, aspirates air and moves into the next sample cup. The sampler moves at a rate of 40 samples per hour with a sample to wash solution ratio of 9:1.

April 13, 2010

- 3.43 Sensitivity – The capability of a test method or instrument to discriminate between measurement responses representing different levels (concentrations) of a variable of interest.
- 3.44 Shall – Denotes a requirement that is mandatory whenever the criterion for conformance with the specification requires that there be no deviation. (ANSI)
- 3.45 Should – Denotes a guideline or recommendation whenever noncompliance with the specification is permissible. (ANSI)
- 3.46 Standard Reference Material (SRM) – Material which has been certified for specific analytes by a variety of analytical techniques and/or by numerous laboratories using similar analytical techniques. These may consist of pure chemicals, buffers, or compositional standards. The materials are used as an indication of the accuracy of a specific analytical technique.

4 INTERFERENCES

- 4.1 Suspended matter in the sample will restrict flow through the apparatus. All samples must be filtered. See Section 8.
- 4.2 High silica concentrations cause positive interferences. Silicon at a concentration of 100 μ M Si causes interferences equivalent to approximately 0.04 μ M P.

5 SAFETY

- 5.1 Safety precautions must be taken when handling reagents, samples and equipment in the laboratory. Protective clothing including lab coats, safety glasses and enclosed shoes should be worn. In certain situations, it will be necessary to also use gloves and/or a face shield. If solutions come in contact with eyes, flush with water continuously for 15 minutes. If solutions come in contact with skin, wash thoroughly with soap and water. Contact Solomons Rescue Squad (911) if emergency treatment is needed and also inform the CBL Business Manager of the incident. Contact the CBL Business Manager if additional treatment is required.
- 5.2 The toxicity or carcinogenicity of each reagent used in this procedure may not have been fully established. Each chemical should be regarded as a potential health hazard and exposure should be as low as reasonably achievable. Cautions are included for known hazardous materials and procedures.
- 5.3 Do not wear jewelry when troubleshooting electrical components. Even low voltage points are dangerous and can injure if allowed to short circuit.
- 5.4 The following hazard classifications are listed for the chemicals used in this procedure. Detailed information is provided on Material Safety Data Sheets (MSDS).

April 13, 2010

Chemical	Health	Flammability	Reactivity	Contact	Storage
Sodium Hydroxide	3	0	2	4	White Stripe
Sulfuric Acid	4	0	2	4	White
Ammonium molybdate	2	0	1	2	Orange
Ascorbic Acid	1	1	0	1	Orange
Potassium antimonyl tartrate hemihydrate	1	0	0	1	Green
Potassium dihydrogen phosphate	1	0	0	1	Green
Chloroform	3	1	1	3	Blue
Hydrochloric Acid	3	0	2	4	White
Acetone	1	4	2	1	Red
Clorox	3	0	2	4	White
Potassium Persulfate	2	0	1	0	Yellow
Boric Acid	2	0	1	2	Green
Sodium dodecyl sulfate (SDS)					

On a scale of 0 to 4 the substance is rated on four hazard categories: health, flammability, reactivity, and contact. (0 is non-hazardous and 4 is extremely hazardous)

STORAGE

Red – Flammability Hazard: Store in a flammable liquid storage area.

Blue – Health Hazard: Store in a secure poison area.

Yellow – Reactivity Hazard: Keep separate from flammable and combustible materials.

White – Contact Hazard: Store in a corrosion-proof area.

Green – Use general chemical storage (On older labels, this category was orange).

Striped – Incompatible materials of the same color class have striped labels. These products should not be stored adjacent to substances with the same color label. Proper storage must be individually determined.

6 EQUIPMENT AND SUPPLIES

6.1 Technicon Bran & Luebbe AutoAnalyzer II sampler, proportioning pump, manifold and colorimeter capable of analyzing for TDP as orthophosphate are used in this laboratory. A PMC Industries Flat Bed Linear recorder is used to record electronic output from the colorimeter.

6.2 Freezer, capable of maintaining $-20 \pm 5^{\circ} \text{C}$.

6.3 Lab ware – All reusable lab ware (glass, Teflon, plastic, etc) should be sufficiently clean for the task objectives. This laboratory cleans all lab ware related to this method with a 10% HCl (v/v) acid rinse. This laboratory cleans all lab ware that has held solutions containing ammonium molybdate with 10% NaOH (w/v) rinse.

6.4 Pressure Cooker with pressure regulator and pressure gauge.

April 13, 2010

6.5 Hot plate with variable heat settings.

7 REAGENTS AND STANDARDS

7.1 Purity of Water – Unless otherwise indicated, references to water shall be understood to mean reagent water conforming to Specification D 1193, Type I. Freshly prepared water should be used for making the standards intended for calibration. The detection limits of this method will be limited by the purity of the water and reagents used to make the standards.

7.2 Purity of Reagents – Reagent grade chemicals shall be used in all tests. Unless otherwise indicated, it is intended that all reagents shall conform to specifications of the Committee on Analytical Reagents of the American Chemical Society, where such specifications are available. Other grades may be used, provided it is first ascertained that the reagent is of sufficiently high purity to permit its use without compromising the accuracy of the determination.

7.3 4.9 N Sulfuric Acid

Sulfuric Acid (concentrated H₂SO₄) 136mL

Deionized water up to 1000 mL

In a 1000 mL volumetric flask, add approximately 700 mL deionized water. Add 136mL H₂SO₄ to the deionized water, let cool, and bring to volume. Write the name of preparer, preparation date, reagent manufacturer, manufacturer lot number in the Analytical Reagent log book. The reagent is stable for one year.

7.4 Ammonium molybdate solution

Ammonium molybdate 8 g

Alkaline water up to 200 mL

In a 200 mL plastic volumetric flask, dissolve, with immediate inversion, 8 g of Ammonium molybdate, in approximately 180 mL deionized water. Bring flask to volume. Store flask in the dark at room temperature. Write the name of preparer, preparation date, reagent manufacturer, manufacturer lot number in the Analytical Reagent log book. The reagent is stable for one month. Discard if white precipitate appears in flask or on threads of cap.

7.5 Potassium antimonyl tartrate solution

Potassium antimonyl tartrate 0.6 g

In a 200 mL plastic volumetric flask dissolve 0.6g Potassium antimonyl tartrate hemihydrate, in approximately 180 mL deionized water. Bring flask up to volume. Store flask at room temperature. Write the name of preparer, preparation date, reagent manufacturer, manufacturer lot number in the Analytical Reagent log book. Reagent is stable for one year.

7.7 Ascorbic acid solution

Ascorbic Acid 1.8 g

April 13, 2010

In a 100 mL plastic volumetric flask dissolve 1.8 g Ascorbic acid in approximately 90 mL deionized water. Bring flask up to volume. Store flask in refrigerator. Write the name of preparer, preparation date, reagent manufacturer, manufacturer lot number in the Analytical Reagent log book. Reagent is stable for two months.

7.8 Triple Reagent

4.9 N Sulfuric Acid	75 mL
Ammonium molybdate solution	22.5 mL
Potassium antimonyl tartrate solution	7.5 mL
SDS	0.15 g

Add 0.15 g SDS to a 200 mL Erlenmeyer glass flask. Add 75 mL Sulfuric Acid to the flask. Carefully add 22.5 mL Ammonium molybdate solution to the flask. Carefully add 7.5 mL Potassium antimonyl tartrate solution to the flask. Carefully swirl the flask to mix the reagent together. Triple reagent is made and used on the day of analysis only.

7.9 Working Ascorbic acid solution

Ascorbic Acid	50 mL
SDS	0.1 g

In a plastic 50 mL beaker, add 0.1 g SDS. Pour in approximately 30 mL Ascorbic acid solution and swirl. When SDS is dissolved, fill beaker up to 50 mL with Ascorbic acid solution. When analysis is complete, cover remaining Working Ascorbic acid solution with parafilm and store in refrigerator. Reagent is stable for one month.

7.10 Orthophosphate Stock Standard, 12,000 μM –

Potassium dihydrogen phosphate (KH_2PO_4), primary standard grade, dried at 45 C	1.632 g
Deionized water	up to 1000 mL

In a 1 L volumetric flask, dissolve 1.632 g of potassium dihydrogen phosphate in approximately 800 mL deionized water. Bring flask to volume with deionized water (1 mL contains 12 $\mu\text{moles P}$). Add 1 mL chloroform as a preservative. Write the name of preparer, preparation date, reagent manufacturer, manufacturer lot number in the Analytical Reagent log book. Make fresh every 6 months.

7.11 Secondary Orthophosphate Standard –

Stock Orthophosphate Standard	1.0 mL
Deionized water	up to 100 mL

In a 100 mL volumetric flask, dilute 1.0 mL of Stock Orthophosphate Standard to 100 mL with deionized water to yield a concentration of 120 $\mu\text{M PO}_4\text{-P/L}$ (1 mL contains 1.2 $\mu\text{moles P}$). Write the name of preparer, preparation date, reagent manufacturer, manufacturer lot number in the Analytical Standard log book. Make fresh every 4 weeks.

7.12 Working Regular Orthophosphate Standard for TDP – See Table 1 for all working Orthophosphate Standards for TDP Working Orthophosphate Standards for TDP are made with Secondary Orthophosphate Standard.

Write the name of preparer, preparation date, reagent manufacturer, manufacturer lot number in the Analytical Standard log book. Make fresh for every digestion batch.

7.13 Glycerophosphate Stock Standard –	
B-Glycerophosphoric acid, disodium salt, 5 hydrate	0.0473 g
Deionized water	up to 500 mL
Chloroform (CHCl ₃)	0.5 mL

In a 500 mL volumetric flask, dissolve 0.0473 g of Glycerophosphoric acid in about 400 mL of deionized water and dilute to 500 mL with deionized water. Add 0.5 mL of chloroform as a preservative. Write the name of preparer, preparation date, reagent manufacturer, manufacturer lot number in the Analytical Standard log book.

7.14 Working Glycerophosphate Standard for TDP – See Table 1 for all working Glutamic Acid Standards for TDP.

Write the name of preparer, preparation date, reagent manufacturer, manufacturer lot number in the Analytical Standard log book. Make fresh for every digestion batch.

7.15 Potassium Persulfate Digestion Reagent –	
Sodium Hydroxide (NaOH)	3 g
Potassium Persulfate (K ₂ S ₂ O ₈), Low N	20.1 g
Deionized water	up to 1000 mL

In a 1000 mL volumetric flask, dissolve 3g of sodium hydroxide and 20.1 g of potassium persulfate in ~800mL of deionized water. Dilute to 1000 mL with deionized water. Write the name of preparer, preparation date, reagent manufacturer, manufacturer lot number in the Analytical Reagent log book. Make fresh daily.

7.16 Borate Buffer Solution –	
Boric Acid (H ₃ BO ₃)	61.8 g
Sodium Hydroxide (NaOH)	8 g
Deionized water	up to 1000 mL

In a 1000 mL volumetric flask, dissolve 61.8 g of boric acid in ~ 300mL deionized water. Add 8g of sodium hydroxide and dilute to 1000mL with deionized water. Write the name of preparer, preparation date, reagent

manufacturer, manufacturer lot number in the Analytical Reagent log book. Make fresh every 4 months.

7 SAMPLE COLLECTION, PRESERVATION, AND STORAGE

- 8.1 Water collected for TDP should be filtered through a Whatman GF/F glass fiber filter (nominal pore size 0.7 μm), or equivalent.
- 8.2 Prior to initial use, capped 30 mL test tubes must be digested with Digestion Reagent, then rinsed thoroughly with deionized water.
- 8.3 An exact amount (typically 10mL) of sample should be added to each sample rinsed, capped 30mL test tube.
- 8.4 Water collected for TDP should be frozen at -20°C .
- 8.5 Frozen TDP samples may be stored longer than 28 days. It has been shown that frozen QCS samples up to a year old still fall well within the control limits.
- 8.6 Digested TDP samples may be stored up to a year.
- 8.7 TDP samples may be refrigerated at 4°C for no longer than one day.

9 QUALITY CONTROL

- 9.1 The laboratory is required to operate a formal quality control (QC) program. The minimum requirements of this program consist of an initial demonstration of laboratory capability and the continued analysis of laboratory instrument blanks and calibration standard material, analyzed as samples, as a continuing check on performance. The laboratory is required to maintain performance records that define the quality of data generated.
- 9.2 Initial Demonstration of Capability
 - 9.2.1 The initial demonstration of capability (TDP) – is used to characterize instrument performance (MDLs) and laboratory performance (analysis of QC samples) prior to the analyses conducted by this procedure.
 - 9.2.2 Quality Control Sample (QCS/SRM) – When using this procedure, a quality control sample is required to be analyzed during the run, to verify data quality and acceptable instrument performance. If the determined concentrations are not within $\pm 10\%$ of the certified values, performance of the determinative step of the method is unacceptable. The source of the problem must be identified and corrected before either proceeding with the initial determination of MDLs or continuing with analyses.
 - 9.2.3 Method Detection Limits (MDLs) – MDLs should be established for TDP using a low level ambient water sample. To determine the MDL values, analyze seven replicate aliquots of water. Perform all calculations defined in the procedure (Sections 11.6-11.8 and Section 13) and report the concentration values in the appropriate units. Calculate the MDL as follows:

$$\text{MDL} = s \times 3$$

April 13, 2010

Where, s = Standard Deviation of the replicate analyses.

- 9.2.4 MDLs shall be determined yearly and whenever there is a significant change in instrument response, a significant change in instrument configuration, or a new matrix is encountered.

9.3 Assessing Laboratory Performance

- 9.3.1 Laboratory Reagent Blank (LRB) – The laboratory must analyze at least one LRB with each batch of samples. The LRB consists of Nanopure water treated the same as the samples. An amount of analyte above the MDL (TDP) found in LRB indicates possible reagent or laboratory environment contamination. LRB data are used to assess and correct contamination from the laboratory environment.
- 9.3.2 Quality Control Sample (QCS)/ Standard Reference Material (SRM) – When using this procedure, a quality control sample is required to be analyzed at the beginning of the run and end of the run, to verify data quality and acceptable instrument performance. If the determined concentrations are not within $\pm 3\sigma$ of the certified values, performance of the determinative step of the method is unacceptable. The source of the problem must be identified and corrected before either proceeding with the initial determination of MDLs or continuing with the analyses. The results of these QCS/SRM samples shall be used to determine sample batch acceptance.
- 9.3.3 The QCS are obtained from a source external to the laboratory and different from the source of calibration standards.
- 9.3.4 Control Charts – The Accuracy Control Chart for QCS/SRM samples is constructed from the average and standard deviation of the 20 most recent QCS/SRM measurements. The accuracy chart includes upper and lower warning levels ($WL = \pm 2s$) and upper and lower control levels ($CL = \pm 3s$). These values are derived from stated values of the QCS/SRM. The standard deviation (s) is specified relative to statistical confidence levels of 95% for WLs and 99% for CLs. Set up an accuracy chart by using percent recovery since the concentration of the QCS/SRM varies. Enter QCS/SRM results on the chart each time the sample is analyzed.
- 9.3.5 Continuing Calibration Verification (CCV) – Following every 18-23 samples, two CCV are analyzed to assess instrument performance. The CCVs are made from the different material than the calibration standards (KH_2PO_4), and are to be within $TV \pm 3\sigma$. Failure to meet the criteria requires correcting the problem, including reanalysis of any affected samples. If not enough sample exists, the data must be qualified if reported. Specific CCV's can be found in Table 1.

9.4 Assessing Analyte Recovery - % Recovery

April 13, 2010

- 9.4.1 Analyte recovery is assessed through percent recoveries of laboratory spikes. Analyte recovery is also assessed through the percent recovery of an organic standard that was digested with each batch of samples.
- 9.4.2 $\% \text{ Recovery} = (\text{Spiked sample concentration} - \text{Sample concentration} / \text{Concentration of spike solution}) \times 100$
- 9.5 Assessing Analyte Precision – Relative Percent Difference (RPD)
- 9.5.1 Analyte replication is assessed through duplicate analyses of samples – Relative Percent Difference.
- 9.5.2 $\text{RPD} = (\text{Laboratory Duplicate Result 1} - \text{Laboratory Duplicate Result 2}) / [(\text{Laboratory Duplicate Result 1} + \text{Laboratory Duplicate Result 2}) / 2] \times 100$
- 9.6 Corrective Actions for Out of Control Data
- 9.6.1 Control limit – If one measurement exceeds Accuracy Control Chart CL, repeat the analysis immediately. If the repeat measurement is within the CL, continue analyses; if it exceeds the CL, discontinue analyses and correct the problem.
- 9.6.2 Warning limit – If two out of three successive points exceed Accuracy Control Chart WL, analyze another sample. If the next point is within WL, continue analyses; if the next point exceeds the WL, evaluate potential bias and correct the problem.
- 9.6.3 Trending – If seven successive Accuracy Control Chart measurements are on the same side of the central line, discontinue analyses and correct the problem.
- 9.6.4 When external QCS samples are out of control, correct the problem. Reanalyze the samples analyzed between the last in-control measurement and the out-of-control one.
- 9.6.5 When external CCV samples are out of control, correct the problem. Reanalyze the samples analyzed between the last in-control measurement and the out-of-control one.
- 9.7 General Operation - To assure optimal operation and analytical results, the Reagent Blank (LRB) and CCV are tracked daily in the raw data file, copied to Reagent Blank (LRB) and CCV Control Charts.

10 CALIBRATION AND STANDARDIZATION

- 10.1 Calibration – Daily calibration must be performed before sample analysis may begin. Four point calibrations are used with the Technicon Bran & Luebbe AutoAnalyzer II in replicates of three. ASTM Type I water is used as the “zero point” in the calibration.
- 10.2 Working TDP Standards – Table 1 defines all working TDP Standards.

April 13, 2010

- 10.3 Prepare standard curve by plotting response on recorder of standards processed through the manifold against TDP as PO_4 -P/L concentration in standards.
- 10.4 Compute sample mg TDP/L concentration by comparing sample response on recorder with standard curve.

11 PROCEDURE – DAILY OPERATION

- 11.1 Attach pump tubes to end rails of Proportioning Pump. Put platen on Proportioning Pump. Allow deionized water to run through the sample line, deionized water mixed with SDS to run through its line and deionized water mixed with SDS to run through both the Ascorbic Acid and Triple Reagent lines. Check for good flow characteristics (good bubble pattern).
- 11.2 Turn on Colorimeter and Recorder. Set Colorimeter Standard Calibration setting to 1.00. Let liquid pump through the Manifold and Colorimeter for 15 minutes.
- 11.3 At the conclusion of the 15 minutes, turn Baseline Knob on Colorimeter to obtain 5 chart units deflection on Recorder.
- 11.4 Insert the Ascorbic Acid line into the Ascorbic Acid solution and the Triple Reagent line into the Triple Reagent solution. At a Colorimeter Standard Calibration setting of 1.00, note deflection on the Recorder. Reject Triple Reagent if deflection is more than 8 out of total 100 chart units. Turn Baseline Knob on the Colorimeter to obtain 0 deflection on Recorder.
- 11.5 At desired Standard Calibration (See Table 1), analyze inorganic linearity check also listed in Table 1. Repeat the top standard to check for good replication. If replicates are not within $\pm 10\%$, repeat. If repeating fails a second time, remake Triple Reagent components and Triple Reagent solution.
- 11.6 Analyze Working TDP Standards using the NAP Software Program. (For NAP Software Program procedures, see Appendix A.) The NAP Software Program will prepare standard curve by plotting response on recorder of standards processed through the manifold against TDP as PO_4 -P/L concentration in standards.
- 11.7 Analyze samples. The NAP Software Program will compute sample TDP as PO_4 -mg P/L concentration by comparing sample response on Recorder with standard curve.
- 11.8 Change the Standard Calibration setting if a sample peak is larger than 100%. Standard Calibration setting of 8.0 can be turned down to 5.0, then 2.0 and finally 1.0. Calculate the Change in Gain by multiplying the peak height times $100/55.5$ for correcting to a Standard Calibration of 5.0, $100/55.5 \times 100/47.6$ for correcting to a Standard Calibration of 2.0, and $100/55.5 \times 100/47.6 \times 100/66.6$ for correcting to a Standard Calibration of 1.0. This will give a corrected peak height. Use the corrected peak height with the daily regression in order to calculate the sample concentration in mg/L.
- 11.9 Allow deionized water to flow through the sample line for 10 minutes. Allow deionized water to flow through the sample, Ascorbic Acid and Triple

April 13, 2010

Reagent lines for one minute. Turn Proportioning Pump switch to fast pump for its allotted time.

- 11.10 Turn off Sampler, Colorimeter and Recorder. Release and remove Proportioning Pump platen. Release pump tubes from end rails.

12 PROCEDURE – SAMPLE DIGESTION

12.1 TDN/TDP samples are digested simultaneously in the same ampule. In our procedures, this ampule is a 30 mL screw cap test tube.

12.2 Prepare working standards, QCS, and CCV in labeled 100 mL volumetric flasks:

12.2.1 Select concentration range for both TDN/TDP that best fits the sample batch from Table 1.

12.2.2 Fill 100 mL volumetric flasks with 80 mL deionized water.

12.2.3 Add appropriate amount of KNO_3 and KH_2PO_4 to each labeled working standard volumetric flask from Table 1.

12.2.4 Add appropriate amount of glutamic/glycerophosphate to each labeled CCV and % recovery volumetric flask from Table 1.

12.2.5 Bring up to 100 mL volume with deionized water.

12.2.6 Mix each 100 mL labeled volumetric flask thoroughly

12.3 Sub-sample working standards into 30mL screw cap test tubes:

12.3.1 Prepare 3, 30mL labeled test tubes for each working standard concentration.

12.3.2 Sample rinse each test tube with the appropriate working standard.

12.3.3 Add exactly 10mL of each working standard to each test tube.

12.3.4 Prepare 3 labeled test tubes with exactly 10 mL deionized water for “0” in the calibration curve.

12.3.5 Set aside 3 empty labeled test tubes to be digested with the batch with digestion reagent only.

12.3.6 Prepare 2, 30mL labeled test tubes for glutamic/glycerophosphate for % recovery by adding exactly 10mL to each test tube.

12.3.7 Prepare 2, 30mL labeled test tubes for glutamic/glycerophosphate for CCV by adding exactly 10mL of the designated CCV solution to each test tube.

12.3.8 Thaw a Quality Control Sample (Spex) sample stored in freezer and sub-sample exactly 10mL into a labeled 30mL test tube to be used for QCS.

12.4 Prepare Digestion Reagent by dissolving 20.1 g Potassium Persulfate and 3 g Sodium Hydroxide in a 1000 mL volumetric flask:

12.4.1 Rinse volumetric flask with deionized water.

12.4.2 Add 20.1 g Potassium Persulfate directly to the volumetric flask.

April 13, 2010

- 12.4.3 Add deionized water until the meniscus is slightly below full volume.
 - 12.4.4 Add 3 g Sodium Hydroxide to the Potassium Persulfate and water solution, cap immediately and mix thoroughly.
 - 12.4.5 Bring to volume with deionized water.
 - 12.4.6 Make fresh daily.
 - 12.4.7 Digestion Reagent is stable for at least 4 hours.
-
- 12.5 When ready to digest, thaw frozen samples at room temperature.
 - 12.6 Rinse dispensing vessel with deionized water and sample rinse with digestion reagent.
 - 12.7 Add thoroughly mixed digestion reagent.
 - 12.8 Set dispensing vessel for desired dispensing volume.
 - 12.9 Add desired amount of digestion reagent, cap tube, shake for mixing and add test tube to pressure cooker.
 - 12.10 Add desired amount of digestion reagent to the standards at the beginning, middle and end of the sequence of loading the samples.
 - 12.11 When all samples and standards have received digestion reagent and have been loaded into the pressure cooker, place pressure cooker on hot plate, add deionized water until tubes are 75% immersed, wet the gasket on the lid with a few drops of water and place lid on the pressure cooker.
 - 12.12 Turn the hot plate on maximum temperature and have the pressure cooker come up to full steam. (This takes about 1 hour.)
 - 12.13 When full steam is achieved, place the pressure regulator on the steam vent. Maintain heat for the cooker containing samples and standards at 3-4 psi for 1 hour.
 - 12.14 Turn off pressure cooker and unplug the hot plate when finished. Keep the lid on the pressure cooker.
 - 12.15 After samples have cooled, usually the next day, remove the pressure cooker lid, add 1 mL Borate Buffer to each tube, cap, and shake.
 - 12.16 Sample batch is now ready to analyze and is stable for 1 year.

13 DATA ANALYSIS AND CALCULATIONS

- 13.1 Upon completion of all analysis, results are saved to a Lotus 123 daily report file. The file is named by the run date. The daily report file for analytical batch of January 1, 2005 would be named 010105tdnp. The instrument software has calculated final sample concentration from the designated standard curve in a program called New Analyzer Program (NAP) Software. Dilution by the analyst is noted and recalculated by multiplying the original peak height times the dilution factor to calculate a corrected peak height. Use the corrected peak height with the daily regression to calculate the sample concentration in mg/L. The analyst examines each peak height and peak marker within the NAP Software and compares it to the peak height from the chart recorder, correcting the placement of the peak marker if necessary. Results are eliminated that are outside the limits of the calibration range.

April 13, 2010

14 METHOD PERFORMANCE

- 14.1 On 27 separate dates from February through July 2008, 27 replicate analyses of SPEX® Corporation QC 6-42 NUT 1 were performed by TDP Alkaline Persulfate Digestion/Ascorbic Acid method. This produced a mean value of 0.2635 mg TDP as PO₄-P/L, SD 0.0076, Relative Percent Difference of 3.3% from the expected value of 0.255 ± 10%. This is a mean recovery of 103%.

15 REFERENCES

- 15.1 Technicon Industrial Method No. 158-71 W/A Tentative. 1977. Technicon Industrial Systems. Tarrytown, New York, 10591.
- 15.2 USEPA. 1979. Method No. 353.2 *in* Methods for chemical analysis of water and wastes. United States Environmental Protection Agency, Office of Research and Development. Cincinnati, Ohio. Report No. EPA-600/4-79-020 March 1979. 460pp.

April 13, 2010

Appendix VII

Range	Pump Tubes	umoles PO4/L	mg P/L	ml 1 PO4 std/100ml	Spike Conc.	Inorganic Check For Linearity	Glycerphosphate for % Recovery	NAP File Created	CCV	Correction Coefficient
		0	0	DI H2O						
TWS TDP	Red/Red sample	2.4	0.0744	2.0	2.5 ml of	1.8 PO4	2 ml Glycerophos.	TWS TDP (group)	1.0 mL Glycerophosphate	2.4 umoles
5 ml sample	Orn/Orn DI w/SDS	6.0	0.186	5.0	400 umole NO3 &	1.2 PO4		TWS TDP (samp. table)		PO4
15 ml persulfate	Std Cal 8.0	12.0	0.372	10.0	12 umole PO4	0.6 PO4				
					Added to 2.5 ml sample prior to digestion	0.3 PO4				
						0.12 PO4				
		0	0	DI H2O						
Low 10 ml sample	Red/Red sample	0.6	0.0186	0.5	12 umole PO4	1.8 PO4	1ml Glycerophos.	Low TDP (group) lowp (samp. table)	0.5 mL Glycerophosphate	2.4 umoles
5 ml persulfate	Orn/Orn DI w/SDS	2.4	0.0744	2.0		1.2 PO4				PO4
	Std Cal 8.0	4.8	0.1488	4.0		0.6 PO4				
						0.3 PO4				
						0.12 PO4				
		0	0	DI H2O						
Low and Salty (Above 35 ppt) 10 ml sample	Wht/Wht sample	0.6	0.0186	0.5	12 umole PO4	3.6 PO4	1ml Glycerophos.	Low TDP (group) lowp (samp. table)	0.5 mL Glycerophosphate	3.6 umoles
5 ml persulfate	Wht/Wht DI w/SDS	2.4	0.0744	2.0		1.8 PO4				PO4
	Std. Cal 8.0	4.8	0.1488	4.0		1.2 PO4				
						0.6 PO4				
						0.3 PO4				

Table 1. Methods and Standards Used for TDP Orthophosphate

April 13, 2010

April 13, 2010

Determination of Total Dissolved Nitrogen (TDN) in Fresh/Estuarine/Coastal Waters Using Alkaline Persulfate Digestion of Nitrogen to Nitrate and Measured Using Enzyme Catalyzed Reduction

1. SCOPE and APPLICATION

1.1 Potassium Persulfate is used to oxidize organic and inorganic nitrogen to NO_3 under heated alkaline conditions.

1.2 Enzyme catalyzed reduction is used to quantitatively reduce dissolved nitrate to nitrite which is then measured by colorimetric quantitative analysis of a highly colored azo dye. The method is used to analyze all ranges of salinity.

1.3 A Method Detection Limit (MDL) of 0.05 mg TDN as $\text{NO}_3\text{-N/L}$ was determined using 3X the standard deviation of 7 replicates.

1.4 The Quantitation Limit for TDN as NO_3 was set at 0.15 mg TDN as $\text{NO}_3\text{-N/L}$.

1.5 This procedure should be used by analysts experienced in the theory and application of aqueous organic and inorganic analysis. Three months experience with an experienced analyst, certified in the analysis of TDN in aqueous samples by enzyme catalyzed reduction is required.

1.6 This method can be used for all programs that require analysis of TDN.

1.7 A portion of this procedure conforms to Standard Methods #4500-N C, 4500-NO3 F and EPA Method 353.2 (1979).

2. SUMMARY

2.1 An exact amount of filtered samples are placed in test tubes where an exact amount of Potassium Persulfate Digestion Reagent is added. Under initially alkaline conditions and heat, nitrate is the sole nitrogen product.

2.2 The now digested samples are mixed with Nitrate Reductase (an enzyme isolated from the plant *Arabidopsis thaliana*) and NADH (β -Nicotinamide adenine dinucleotide reduced form disodium salt). The nitrite, both that which was reduced from nitrate and nitrite that was originally present, is then determined by diazotizing with sulfanilamide and coupling with N-1-naphthylethylenediamine dihydrochloride to form a colored azo dye.

3. DEFINITIONS

3.1 Acceptance Criteria – Specified limits placed on characteristics of an item, process, or service defined in a requirement document. (ASQC)

3.2 Accuracy – The degree of agreement between an observed value and an accepted reference value. Accuracy includes a combination of random error (precision) and systematic error (bias) components which

April 13, 2010

- are due to sampling and analytical operations; a data quality indicator. (QAMS)
- 3.3 Aliquot – A discrete, measured, representative portion of a sample taken for analysis. (EPA QAD Glossary)
- 3.4 Analytical Range – There are multiple analytical ranges/standard curves used for determination of TDN. See Table 1 for all analytical ranges used.
- 3.5 Batch – Environmental samples, which are prepared and /or analyzed together with the same process and personnel, using the same lot(s) of reagents. A **preparation batch** is composed of one to 300 environmental samples of the same matrix, meeting the above mentioned criteria and with a maximum time between the start of processing of the first and last sample in the batch to be 10 hours. An **analytical batch** is composed of prepared environmental samples (extracts, digestates, or concentrates) and/or those samples not requiring preparation, which are analyzed together as a group using the same calibration curve or factor. An analytical batch can include samples originating from various environmental matrices and can exceed 20 samples. (NELAC/EPA)
- 3.6 Blank- A sample that has not been exposed to the analyzed sample stream in order to monitor contamination during sampling, transport, storage or analysis. The blank is subjected to the usual analytical and measurement process to establish a zero baseline or background value and is sometimes used to adjust or correct routine analytical results. (ASQC)
- 3.7 Calibrate- To determine, by measurement or comparison with a standard, the correct value of each scale reading on a meter or other device, or the correct value for each setting of a control knob. The levels of the applied calibration standard should bracket the range of planned or expected sample measurements. (NELAC)
- 3.8 Calibration – The set of operations which establish, under specified conditions, the relationship between values indicated by a measuring device. The levels of the applied calibration standard should bracket the range of planned or expected sample measurements. (NELAC)
- 3.9 Calibration Blank – A volume of reagent water fortified with the same matrix as the calibration standards, without the analyte added.
- 3.10 Calibration Curve – The graphical relationship between known values, such as concentrations, or a series of calibration standards and their analytical response. (NELAC)
- 3.11 Calibration Method – A defined technical procedure for performing a calibration. (NELAC)
- 3.12 Calibration Standard – A substance or reference material used to calibrate an instrument. (QAMS)
- 3.12.1 Initial Calibration Standard (STD) – A series of standard solutions used to initially establish instrument calibration

- responses and develop calibration curves for individual target analytes.
- 3.12.2 Initial Calibration Verification (ICV) – An individual standard, analyzed initially, prior to any sample analysis, which verifies acceptability of the calibration curve or previously established calibration curve.
 - 3.12.3 Continuing Calibration Verification (CCV) – An individual standard which is analyzed after every 15-20 field sample analysis.
- 3.13 Certified Reference Material – A reference material one or more of whose property values are certified by a technically valid procedure, accompanied by or traceable to a certificate or other documentation which is issued by a certifying body. (ISO 17025)
 - 3.14 Corrective Action – Action taken to eliminate the causes of an existing nonconformity, defect or other undesirable situation in order to prevent recurrence. (ISO 8402)
 - 3.15 Deficiency – An unauthorized deviation from acceptable procedures or practices. (ASQC)
 - 3.16 Demonstration of Capability – A procedure to establish the ability of the analyst to generate acceptable accuracy. (NELAC)
 - 3.17 Detection Limit – The lowest concentration or amount of the target analyte that can be determined to be different from zero by a single measurement at a stated degree of confidence.
 - 3.18 Duplicate Analysis – The analyses of measurements of the variable of interest performed identically on two sub samples (aliquots) of the same sample. The results from duplicate analyses are used to evaluate analytical or measurement precision but not the precision of sampling, preservation or storage internal to the laboratory. (EPA-QAD)
 - 3.19 External Standard (ES) – A pure analyte (potassium nitrate (KN O₃)) that is measured in an experiment separate from the experiment used to measure the analyte(s) in the sample. The signal observed for a known quantity of the pure external standard is used to calibrate the instrument response for the corresponding analyte(s). The instrument response is used to calculate the concentrations of the analyte(s) in the unknown sample.
 - 3.20 Field Duplicates (FD1 and FD2) – Two separate samples collected at the same time and place under identical circumstances and treated exactly the same throughout field and laboratory procedures. Analyses of FD1 and FD2 provide a measure of the precision associated with sample collection, preservation and storage, as well as with laboratory procedures.
 - 3.21 Field Reagent Blank (FRB) – A aliquot of reagent water or other blank matrix that is placed in a sample container in the laboratory and treated as a sample in all respects, including shipment to the sampling site, exposure to the sampling site conditions, storage, preservation, and all analytical procedures. The purpose of the FRB is to determine

if method analytes or other interferences are present in the field environment.

- 3.22 Holding time – The maximum time that samples may be held prior to analysis and still be considered valid. (40 CFR Part 136) The time elapsed from the time of sampling to the time of extraction or analysis, as appropriate.
- 3.23 Instrument Detection Limit (IDL) – The minimum quantity of analyte of the concentration equivalent which gives an analyte signal equal to three times the standard deviation of the background signal at the selected wavelength, mass, retention time absorbance line, etc.
- 3.24 Laboratory Duplicates (LD1 and LD2) – Two aliquots of the same sample taken in the laboratory and analyzed separately with identical procedures. Analyses of LD1 and LD2 indicate precision associated with laboratory procedures, but not with sample collection, preservation, or storage procedures.
- 3.25 Laboratory Reagent Blank (LRB) – A blank matrix (i.e., DI water) that is treated exactly as a sample including exposure to all glassware, equipment, solvents, and reagents that are used with other samples. The LRB is used to determine if method analytes or other interferences are present in the laboratory environment, the reagents, or the instrument.
- 3.26 Laboratory Control Sample (LCS) – A sample matrix, free from the analytes of interest, spiked with verified known amounts of analytes from a source independent of the calibration standard or a material containing known and verified amounts of analytes. The LCS is generally used to establish intra-laboratory or analyst-specific precision and bias or to assess the performance of all or a portion of the measurement system. (NELAC)
- 3.27 Limit of Detection (LOD) – The lowest concentration level that can be determined by a single analysis and with a defined level of confidence to be statistically different from a blank. (ACS)
- 3.28 Limit of Quantitation (LOQ) – The minimum levels, concentrations, or quantities of a target variable (target analyte) that can be reported with a specified degree of confidence. The LOQ is set at 3 to 10 times the LOD, depending on the degree of confidence desired.
- 3.29 Linear Dynamic Range (LDR) – The absolute quantity over which the instrument response to an analyte is linear. This specification is also referred to as the Linear Calibration Range (LCR).
- 3.30 Manifold – The module whose configuration of glass connectors, fittings, mixing coils, tubing and Cadmium-Copper reduction column precisely reduces the nitrate in the sample to nitrite, followed by color production.
- 3.31 Material Safety Data Sheets (MSDS) – Written information provided by vendors concerning a chemical's toxicity, health hazards,

physical properties, fire, and reactivity data including storage, spill, and handling precautions.

- 3.32 May – Denotes permitted action, but not required action. (NELAC)
- 3.33 Method Detection Limit (MDL) – The minimum concentration of an analyte that can be identified, measured, and reported with 99% confidence that the analyte concentration is greater than zero.
- 3.34 Must – Denotes a requirement that must be met. (Random House College Dictionary)
- 3.35 Photometer – measures the absorbance of the solution in the cell in a multicell cuvette. Light passes from the lamp through the condensing lenses to the interference filter. The plane surface of the first condensing lens is coated with a material which reflects heat and infrared light. The filters are mounted on a filter wheel. There are 15 positions for filters. Each filter corresponds to a wavelength of interest. The 540 nm filter is specified by the test definition for nitrate plus nitrite. After passing through the filter the light is converted into a stream of light pulses by a chopper. Then the light is directed via a quartz fiber through a focusing lens and a slit to the beam divider. The beam divider divides the light into two parts. A specified portion is reflected to the reference detector, which monitors the light level fluctuations. The remaining major portion of the light beam goes through the liquid in the cell to the signal detector, which measures the amount of light absorbed.
- 3.36 Precision – The degree to which a set of observations or measurements of the same property, obtained under similar conditions, conform to themselves; a data quality indicator. Precision is usually expressed as standard deviation, variance or range, in either absolute or relative terms. (NELAC)
- 3.37 Preservation – Refrigeration, freezing, and/or reagents added at the time of sample collection (or later) to maintain the chemical and or biological integrity of the sample.
- 3.38 Quality Control Sample (QCS) – A sample of analyte of known and certified concentration. The QCS is obtained from a source external to the laboratory and different from the source of calibration standards. It is used to check laboratory performance with externally prepared test materials.
- 3.39 Run Cycle – Typically a day of operation – the entire analytical sequence from sampling the first standard to the last sample of the day.
- 3.40 Sample Segment – Bar-coded metal tray that holds up to fourteen four milliliter auto analyzer vials containing samples or standards. The user identifies each vial in the operating software.
- 3.41 Sample Segment Holder – An automated temperature controlled carousel that contains up to six sample segments. This carousel spins in clockwise or counterclockwise manner to move the sample

segments into position for analysis. This carousel format allows for continuous processing.

- 3.42 Sensitivity – The capability of a test method or instrument to discriminate between measurement responses representing different levels (concentrations) of a variable of interest.
- 3.43 Shall – Denotes a requirement that is mandatory whenever the criterion for conformance with the specification requires that there be no deviation. (ANSI)
- 3.44 Should – Denotes a guideline or recommendation whenever noncompliance with the specification is permissible. (ANSI)
- 3.45 Standard Reference Material (SRM) – Material which has been certified for specific analytes by a variety of analytical techniques and/or by numerous laboratories using similar analytical techniques. These may consist of pure chemicals, buffers, or compositional standards. The materials are used as an indication of the accuracy of a specific analytical technique.
- 3.46 Test Definition – A photometric test consisting of a user defined testing sequence, reagent additions, calibration standards, incubations and absorption results.
- 3.47 Test Flow – Functions to define the parameter for reagent and sample dispensing, dilution, incubation and measurement.

4 INTERFERENCES

- 4.1 Metals, highly reduced substances, and excessive amounts of nitrogen have the potential of using up potassium persulfate before all nitrogen products have been oxidized.
- 4.2 Suspended matter in the sample will scatter light as it passes through the cuvette to the detector. High blank responses will result. The identified sample will be reanalyzed.
- 4.3 Blemishes in the cuvette, as result of the manufacturing process, will result in high blank responses. The identified sample will be reanalyzed.

5 SAFETY

- 5.1 Safety precautions must be taken when handling reagents, samples and equipment in the laboratory. Protective clothing including lab coats, safety glasses and enclosed shoes should be worn. In certain situations, it will be necessary to also use gloves and/or a face shield. If solutions come in contact with eyes, flush with water continuously for 15 minutes. If solutions come in contact with skin, wash thoroughly with soap and water. Contact Solomons Rescue Squad (911) if emergency treatment is needed and also inform the CBL Business Manager of the incident. Contact the CBL Business Manager if additional treatment is required.

April 13, 2010

- 5.2 The toxicity or carcinogenicity of each reagent used in this procedure may not have been fully established. Each chemical should be regarded as a potential health hazard and exposure should be as low as reasonably achievable. Cautions are included for known hazardous materials and procedures.
- 5.3 Do not wear jewelry when troubleshooting electrical components. Even low voltage points are dangerous and can injure if allowed to short circuit.
- 5.4 The following hazard classifications are listed for the chemicals used in this procedure. Detailed information is provided on Material Safety Data Sheets (MSDS).

Chemical	Health	Flammability	Reactivity	Contact	Storage
Sodium Hydroxide	3	0	2	4	White Stripe
Potassium hydroxide	3	0	2	4	White
Potassium phosphate	2	0	3	2	Green
Sulfanilamide	0	1	1	1	Green
N-1-naphthylethylenediamine dihydrochloride	2	1	1	2	Green
Nitrate Reductase (AtNaR2) from <i>Arabidopsis thaliana</i>	0	0	0	0	Green
NADH (β -Nicotinamide adenine dinucleotide reduced form disodium salt)	0	0	0	0	Green
Hydrochloric Acid	3	0	2	4	White
Potassium nitrate	2	0	3	2	Yellow
Sodium nitrite	2	0	3	2	Yellow
Chloroform	3	1	1	3	Blue
Potassium Persulfate	2	0	1	0	Yellow
Boric Acid	2	0	1	2	Green
EDTA (Ethylenediamine tetraacetic acid)	1	0	0	1	Green

On a scale of 0 to 4 the substance is rated on four hazard categories: health, flammability, reactivity, and contact. (0 is non-hazardous and 4 is extremely hazardous)

STORAGE

Red – Flammability Hazard: Store in a flammable liquid storage area.

Blue – Health Hazard: Store in a secure poison area.

Yellow – Reactivity Hazard: Keep separate from flammable and combustible materials.

White – Contact Hazard: Store in a corrosion-proof area.

Green – Use general chemical storage (On older labels, this category was orange).

April 13, 2010

Striped – Incompatible materials of the same color class have striped labels. These products should not be stored adjacent to substances with the same color label. Proper storage must be individually determined.

6 EQUIPMENT AND SUPPLIES

- 6.1 Aquakem 250 multi-wavelength automated discrete photometric analyzer. Aquakem 250 control software operates on a computer running Microsoft Windows NT or XP operating system.
- 6.2 Freezer, capable of maintaining $-20 \pm 5^{\circ} \text{C}$.
- 6.3 Lab ware – All reusable lab ware (glass, Teflon, plastic, etc) should be sufficiently clean for the task objectives. This laboratory cleans all lab ware related to this method with a 10% HCl (v/v) acid rinse.
- 6.4 Pressure Cooker with pressure regulator and pressure gauge.
- 6.5 Hot plate with variable heat settings.

7 REAGENTS AND STANDARDS

- 7.1 Purity of Water – Unless otherwise indicated, references to water shall be understood to mean reagent water conforming to Specification D 1193, Type I. Freshly prepared water should be used for making the standards intended for calibration. The detection limits of this method will be limited by the purity of the water and reagents used to make the standards.
- 7.2 Purity of Reagents – Reagent grade chemicals shall be used in all tests. Unless otherwise indicated, it is intended that all reagents shall conform to specifications of the Committee on Analytical Reagents of the American Chemical Society, where such specifications are available. Other grades may be used, provided it is first ascertained that the reagent is of sufficiently high purity to permit its use without compromising the accuracy of the determination.
- 7.3 Ethylenediamine tetraacetic acid (EDTA, 25 mM) 9.3 g
In a 1 L volumetric flask add approximately 800 mL deionized water. Dissolve 9.3 g ultrapure EDTA in deionized water and bring to volume. Write name of preparer, preparation date, reagent manufacturer, manufacturer's lot number in the Analytical Reagent log book. Store the flask at room temperature out of direct sunlight. The reagent is stable for one year.
- 7.4 Phosphate Buffer-

Potassium di-hydrogen phosphate (KH_2PO_4)	1.88 g
Potassium hydroxide (KOH)	0.7 g
EDTA (25 mM)	5.0 mL

 In a 500mL volumetric flask dissolve 1.88 g KH_2PO_4 , 0.7g KOH and 5.0 mL EDTA (25mM) in approximately 400 mL deionized water. Bring flask to 500 mL volume. Store the flask at room temperature. Write name of preparer, preparation date, reagent manufacturers, manufacturers' lot numbers in the Analytical Reagent log book. The reagent is stable for six months.

April 13, 2010

7.5 Nitrate Reductase (AtNaR2)-

Nitrate reductase from <i>Arabidopsis Thaliana</i>	3.0 unit vial
Phosphate Buffer	20 mL

Transfer 1mL phosphate buffer to the 3.0 unit vial of AtNaR2 to affect dissolution. Shake several times over a thirty minute period. Transfer this to the 20mL reagent bottle quantitatively with four 1 ml aliquots of the phosphate buffer. Add 15mL of phosphate buffer to the reagent bottle. Shake bottle to complete the reagent preparation. This is enough reagent for approximately 300 analyses. Write name of preparer, preparation date, reagent manufacturers, manufacturers' lot numbers in the Analytical Reagent log book. This reagent is stable for eight hours in the refrigerated reagent compartment of the instrument.

7.6 NADH-

(β -Nicotinamide adenine dinucleotide reduced form disodium salt)	2.4 g vial
Phosphate Buffer	11 mL

Carefully transfer NADH crystals from vial to 20 mL reagent bottle. Place 1 mL phosphate buffer in vial and shake thoroughly. Transfer to reagent bottle. Add 10 mL phosphate buffer to the reagent bottle. Shake to complete reagent preparation. This is enough reagent for approximately 300 analyses. Write name of preparer, preparation date, reagent manufacturers, manufacturers' lot numbers in the Analytical Reagent log book. This reagent is stable for eight hours in the refrigerated reagent compartment of the instrument.

7.7 Sulfaniamide-

Sulfanilamide	10 g
Hydrochloric Acid (concentrated)	300 mL

Add 500 mL deionized water to a 1 L volumetric flask. Carefully add 300 mL concentrated hydrochloric acid to the flask. Then add 10 g sulfanilamide to the flask. Bring the flask to volume with deionized water. Once dissolution is complete transfer reagent to a brown poly-bottle and store in the refrigerator. Write name of preparer, preparation date, reagent manufacturers, manufacturers' lot numbers in the Analytical Reagent log book. This reagent is stable for six months.

7.8 N-1-naphthylethylenediamine dihydrochloride –

N-1-naphthylethylenediamine dihydrochloride	1.0 g
---	-------

Place 1.0 g N-1-naphthylethylenediamine dihydrochloride in a 1 L volumetric flask. Bring flask to volume with deionized water. Once dissolution is complete transfer reagent to a brown poly-bottle and store in refrigerator. Write name of preparer, preparation date, reagent

manufacturer, manufacturer's lot number in the Analytical Reagent log book. This reagent is stable for six months.

7.9 Nitrate Stock Standard, 5000 μM –

Potassium nitrate (KNO_3), primary standard grade, dried at 45°C	0.5055 g
Deionized water	up to 1000 mL

In a 1000 mL volumetric flask, dissolve 0.5055 g of potassium nitrate in ~800 mL of deionized water. Dilute to 1000 mL with deionized water (1 mL contains 5 $\mu\text{moles N}$). Write the name of preparer, preparation date, reagent manufacturer, manufacturer lot number in the Analytical Standard log book. Make fresh every 4 months or when < 20% remains in bottle.

7.10 Working Nitrate Standard for TDN – See Table 1 for all working Nitrate Standards for TDN.

Write the name of preparer, preparation date, reagent manufacturer, manufacturer lot number in the Analytical Standard log book. Make fresh for every digestion batch.

7.11 Glutamic Acid Stock Standard, –

Glutamic Acid dried at 45°C	0.3705 g
Deionized water	up to 500 mL
Chloroform (CHCl_3)	0.5 mL

In a 500 mL volumetric flask, dissolve 0.3705 g of glutamic acid in about 400 mL of deionized water and dilute to 500 mL with deionized water. Add 0.5 mL of chloroform as a preservative. Write the name of preparer, preparation date, reagent manufacturer, manufacturer lot number in the Analytical Standard log book.

7.12 Working Glutamic Acid Standard for TDN – See Table 1 for all working Glutamic Acid Standards for TDN.

Write the name of preparer, preparation date, reagent manufacturer, manufacturer lot number in the Analytical Standard log book. Make fresh for every digestion batch.

7.13 Potassium Persulfate Digestion Reagent –

Sodium Hydroxide (NaOH)	3 g
Potassium Persulfate ($\text{K}_2\text{S}_2\text{O}_8$), Low N	20.1 g
Deionized water	up to 1000 mL

In a 1000 mL volumetric flask, dissolve 3g of sodium hydroxide and 20.1 g of potassium persulfate in ~800mL of deionized water. Dilute to 1000 mL with deionized water. Write the name of preparer, preparation date, reagent manufacturer, manufacturer lot number in the Analytical Reagent

April 13, 2010

log book. Make fresh daily. See Table 1 for Targeted Watershed Samples (TWS).

7.14 Borate Buffer Solution –

Boric Acid (H ₃ BO ₃)	61.8 g
Sodium Hydroxide (NaOH)	8 g
Deionized water	up to 1000 mL

In a 1000 mL volumetric flask, dissolve 61.8 g of boric acid in ~ 300mL deionized water. Add 8g of sodium hydroxide and dilute to 1000mL with deionized water. Write the name of preparer, preparation date, reagent manufacturer, manufacturer lot number in the Analytical Reagent log book. Make fresh every 4 months.

7.15 Aquakem Cleaning Solution –

Clorox	75.0 mL
--------	---------

In a 100 mL volumetric flask, dilute 75.0 mL of Clorox to volume with deionized water to yield a concentration of 75% Clorox. Write name of preparer, preparation date, reagent manufacturer, manufacturer lot number in the Analytical Reagent log book. This reagent is stable for six months.

8 SAMPLE COLLECTION, PRESERVATION, AND STORAGE

8.1 Water collected for TDN should be filtered through a Whatman GF/F glass fiber filter (nominal pore size 0.7 µm), or equivalent.

8.2 Prior to initial use, capped 30 mL test tubes must be digested with Digestion Reagent, then rinsed thoroughly with deionized water.

8.3 An exact amount (typically 10mL) of sample should be added to each sample rinsed, capped 30mL test tube.

8.4 Water collected for TDN should be frozen at -20° C.

8.5 Frozen TDN samples may be stored longer than 28 days. It has been shown that frozen QCS samples up to a year old still fall well within the control limits.

8.6 Digested TDN samples may be stored up to a year.

8.7 TDN samples may be refrigerated at 4° C for no longer than one day.

9 QUALITY CONTROL

9.1 The laboratory is required to operate a formal quality control (QC) program.

The minimum requirements of this program consist of an initial demonstration of laboratory capability and the continued analysis of laboratory instrument blanks and calibration standard material, analyzed as samples, as a continuing check on performance. The laboratory is required to maintain performance records that define the quality of data generated.

9.2 Initial Demonstration of Capability

April 13, 2010

- 9.2.1 The initial demonstration of capability (TDN) – is used to characterize instrument performance (MDLs) and laboratory performance (analysis of QC samples) prior to the analyses conducted by this procedure.
- 9.2.2 Quality Control Sample (QCS/SRM) – When using this procedure, a quality control sample is required to be analyzed during the run, to verify data quality and acceptable instrument performance. If the determined concentrations are not within $\pm 10\%$ of the certified values, performance of the determinative step of the method is unacceptable. The source of the problem must be identified and corrected before either proceeding with the initial determination of MDLs or continuing with analyses.
- 9.2.3 Method Detection Limits (MDLs) – MDLs should be established for TDN using a low level ambient water sample. To determine the MDL values, analyze seven replicate aliquots of water. Perform all calculations defined in the procedure (Section xx) and report the concentration values in the appropriate units. Calculate the MDL as follows:

$$\text{MDL} = s \times 3$$

Where, s = Standard Deviation of the replicate analyses.

- 9.2.4 MDLs shall be determined yearly and whenever there is a significant change in instrument response, a significant change in instrument configuration, or a new matrix is encountered.

9.3 Assessing Laboratory Performance

- 9.3.1 Laboratory Reagent Blank (LRB) – The laboratory must analyze at least one LRB with each batch of samples. The LRB consists of Nanopure water treated the same as the samples. An amount of analyte above the MDL (TDN) found in LRB indicates possible reagent or laboratory environment contamination. LRB data are used to assess and correct contamination from the laboratory environment.
- 9.3.2 Quality Control Sample (QCS)/ Standard Reference Material (SRM) – When using this procedure, a quality control sample is required to be analyzed at the beginning of the run and end of the run, to verify data quality and acceptable instrument performance. If the determined concentrations are not within $\pm 3\sigma$ of the certified values, performance of the determinative step of the method is unacceptable. The source of the problem must be identified and corrected before either proceeding with the initial determination of MDLs or continuing with the analyses. The results of these QCS/SRM samples shall be used to determine sample batch acceptance.
- 9.3.3 The QCS are obtained from a source external to the laboratory and different from the source of calibration standards.

April 13, 2010

- 9.3.4 Control Charts – The Accuracy Control Chart for QCS/SRM samples is constructed from the average and standard deviation of the 20 most recent QCS/SRM measurements. The accuracy chart includes upper and lower warning levels ($WL=\pm 2s$) and upper and lower control levels ($CL=\pm 3s$). These values are derived from stated values of the QCS/SRM. The standard deviation (s) is specified relative to statistical confidence levels of 95% for WLs and 99% for CLs. Set up an accuracy chart by using percent recovery since the concentration of the QCS/SRM varies. Enter QCS/SRM results on the chart each time the sample is analyzed
- 9.3.5 Continuing Calibration Verification (CCV) – Following every 18-23 samples, two CCV are analyzed to assess instrument performance. The CCVs are made from the different material than the calibration standards (KNO_3), and are to be within $TV \pm 3\sigma$. Failure to meet the criteria requires correcting the problem, including reanalysis of any affected samples. If not enough sample exists, the data must be qualified if reported. Specific CCV's can be found in Table 1.
- 9.4 Assessing Analyte Recovery - % Recovery
- 9.4.1 Analyte recovery is assessed through percent recoveries of laboratory spikes. Analyte recovery is also assessed through the percent recovery of an organic standard that was digested with each batch of samples.
- 9.4.2 $\% \text{ Recovery} = (\text{Spiked sample concentration} - \text{Sample concentration} / \text{Concentration of spike solution}) \times 100$
- 9.5 Assessing Analyte Precision – Relative Percent Difference (RPD)
- 9.5.1 Analyte replication is assessed through duplicate analyses of samples – Relative Percent Difference.
- 9.5.2 $RPD = (\text{Laboratory Duplicate Result 1} - \text{Laboratory Duplicate Result 2}) / [(\text{Laboratory Duplicate Result 1} + \text{Laboratory Duplicate Result 2}) / 2] \times 100$
- 9.6 Corrective Actions for Out of Control Data
- 9.6.1 Control limit – If one measurement exceeds Accuracy Control Chart CL, repeat the analysis immediately. If the repeat measurement is within the CL, continue analyses; if it exceeds the CL, discontinue analyses and correct the problem.
- 9.6.2 Warning limit – If two out of three successive points exceed Accuracy Control Chart WL, analyze another sample. If the next point is within WL, continue analyses; if the next point exceeds the WL, evaluate potential bias and correct the problem.
- 9.6.3 Trending – If seven successive Accuracy Control Chart measurements are on the same side of the central line, discontinue analyses and correct the problem.

April 13, 2010

- 9.6.4 When external QCS samples are out of control, correct the problem. Reanalyze the samples analyzed between the last in-control measurement and the out-of-control one.
- 9.6.5 When external CCV samples are out of control, correct the problem. Reanalyze the samples analyzed between the last in-control measurement and the out-of-control one.

9.7 General Operation - To assure optimal operation and analytical results, the Reagent Blank (LRB) and CCV are tracked daily in the raw data file, copied to Reagent Blank (LRB) and CCV Control Charts.

10 CALIBRATION AND STANDARDIZATION

- 10.1 Calibration – Daily calibration must be performed before sample analysis may begin. Multiple point calibrations (See Table 1) are used with the Aquakem 250. ASTM Type I water is used as the “zero point” in the calibration.
- 10.2 Working TDN Standards – See Table 1 for all working TDN Standards.
- 10.3 The instrument software prepares a standard curve for each set of calibrators. A graph plotting measured absorbance against standard concentration is presented for review and approval. If acceptance criteria are not met the entire curve can be reanalyzed or individual standards can be reanalyzed. One standard value (original or reanalyzed) for each and every standard is incorporated in the curve. The coefficient of determination (Person’s r value) for the calibration curve as well as the calculated concentration of each calibrator is reviewed. The calculated value of each calibrator must be within ten percent of the expected value. The coefficient of determination (Person’s r value) for the calibration curve must be greater than 0.990.

11 PROCEDURE – DAILY OPERATIONS QUALITY CONTROL

- 11.1 Turn on computer. Computer will automatically initiate Konelab software. Once software is running, turn on instrument and allow connection between instrument and computer to complete.
- 11.2 Discard any water remaining in the water reservoir from the previous analytical run. Fill the water reservoir with fresh deionized water.
- 11.3 Begin daily bench sheet documentation. Remove nitrate reductase and NADH vials from freezer.
- 11.4 Once water reservoir is full, “perform washes” – complete five wash cycles and then initiate “start-up” at main menu.
- 11.5 Gather reagents from refrigerator during start-up and assess reagents. Remake anything that has exceeded the time over which it is considered stable. Nitrate reductase and NADH reagents are made fresh for every analytical run.

April 13, 2010

- 11.6 Once startup is complete, check that the instrument water blank of water from the reservoir has performed within acceptance limits. If any of the instrument functions are outside their predefined and software controlled limits, the user will be notified on the main menu page. User takes corrective action to return instrument functions to controlled limits.
- 11.7 Load reagents into reagent carousel and place into refrigerated reagent compartment.
- 11.8 Load working standards into a sample segment, identify the standards in their positions from the drop down menus at the individual segment positions, and load into instrument.
- 11.9 Select the methods to be calibrated. Three different methods may be calibrated – TDN LOW, TDN XHigh and TDN TWS are the method names to be selected in the software.
- 11.10 Begin calibration – See test flow below for stepwise instrument functions for the analysis of standards and samples.

Test Flow – Method of Analysis, Stepwise

- 55 μ L NiR AtNaR to cuvette
 - 5 μ L sample to cuvette with mixing
 - 15 μ L NiR NADH to cuvette with mixing
 - Incubation, 600 seconds, 37°C
 - 25 μ L sulfanilamide (SAN) reagent to cuvette with mixing
 - Incubation, 120 seconds, 37°C
 - 25 μ L N-1-Naphthylethylenediamine dihydrochloride (NED) reagent to cuvette with mixing
 - Incubation, 120 seconds, 37°C
 - End point absorbance measurement, 540 nm
 - Side-wavelength measurement, 700 nm
 - Software processes absorbance value, side wave length value and uses calibration curve to calculate analyte concentration (mg/L N as NO₂)
 - User is notified if any measured values used to calculate final concentration are outside preset limits. If so, analyst has options to accept the results, rerun the sample or rerun the sample diluted to a user or software specified factor.
 - User is notified of each side wave length value. Side wave length >0.002 absorbance units indicates a scratched cuvette or turbid sample. If the side wave length value exceeds 0.002 absorbance units, the analyst specifies that the sample is reanalyzed. If the side wave length of the reanalyzed sample is <0.002 absorbance units, the reanalyzed result is accepted. If the same concentration and side wave length >0.002 absorbance units is again obtained, the results are accepted.
- 11.11 Organize and sub-sample into cups the samples, reagent blanks, check standards and all quality control samples while instrument performs calibrations.
- 11.12 As calibration curves are produced by the instrument, review them for acceptability. The instrument software prepares a standard curve

April 13, 2010

for each set of calibrators. A graph plotting measured absorbance against standard concentration is presented for review and approval. If acceptance criteria are not met, either the entire curve shall be reanalyzed or individual standards shall be reanalyzed, depending on the violation. One standard value (original or reanalyzed) for each and every calibrator is incorporated in the curve.

- 11.13 Once the calibration curve is accepted, samples are loaded into the segments and analyzed. CCV (Continuing Calibration Verification) samples follow every 18-23 samples. Standard Reference Material (SRM) samples, as well as Laboratory Reagent Blanks (LRB) are scattered throughout the analytical batch. Throughout the analytical batch, samples are chosen as laboratory duplicates and laboratory spikes to assess analytical precision and analyte recovery, respectively. The total number of duplicates and spikes performed will be equal or greater to ten percent of the total number of samples in the analytical batch.
- 11.14 As sample analysis is complete, results must be reviewed and accepted manually. If results fall outside acceptance limits, the sample should be reanalyzed. If sample result exceeds the highest standard of the calibration range it was run within, the samples are automatically diluted by the instrument and reanalyzed.
- 11.15 Upon completion of all analysis, results are saved to a daily report file. The file is named by the run date. The daily report file for analytical batch of July 1, 2005 would be named 070105. The file is converted to Microsoft Excel for data work up. Remaining samples are discarded.
- 11.16 All reagents are removed from the reagent chamber and returned to the refrigerator. Reagents that have exceeded their stability period are discarded.
- 11.17 Aquakem Cleaning Solution is inserted into the instrument and shut down procedures are initiated. Daily files are cleared from the instrument software, the software is exited and the instrument is shut down. The computer is shut down.
- 11.18 The waste is flushed down the drain with copious amounts of tap water. The waste cuvette box is moved to the fume hood. The incubator cover plate is removed. The incubator is wiped clean. The cover is cleaned and returned to its original position.

12 PROCEDURE – SAMPLE DIGESTION

12.1 TDN/TDP samples are digested simultaneously in the same ampule. In our procedures, this ampule is a 30 mL screw cap test tube. (See Table 1 for all TWS samples.)

12.2 Prepare working standards, QCS, and CCV in labeled 100 mL volumetric flasks:

- 12.2.1 Select concentration range for both TDN/TDP that best fits the sample batch from Table 1.
- 12.2.2 Fill 100 mL volumetric flasks with 80 mL deionized water.
- 12.2.3 Add appropriate amount of KNO_3 stock standard and KH_2PO_4 secondary standard solution to each labeled working standard volumetric flask from Table 1.
- 12.2.4 Add appropriate amount of glutamic acid and glycerophosphate working standard solutions to each labeled CCV and % recovery volumetric flask from Table 1.
- 12.2.5 Bring up to 100 mL volume with deionized water.
- 12.2.6 Mix each 100 mL labeled volumetric flask thoroughly

12.3 Sub-sample working standards into 30mL screw cap test tubes:

- 12.3.1 Prepare 2, 30mL labeled test tubes for each working standard concentration.
- 12.3.2 Sample rinse each test tube with the appropriate working standard.
- 12.3.3 Add exactly 10mL of each working standard to each test tube.
- 12.3.4 Prepare 2 labeled test tubes with exactly 10 mL deionized water for “0” in the calibration curve.
- 12.3.5 Set aside 2 empty labeled test tubes to be digested with the batch with digestion reagent only.
- 12.3.6 Prepare 2, 30mL labeled test tubes for glutamic/glycerophosphate for % recovery and CCV by adding exactly 10mL to each test tube.
- 12.3.7 Thaw a Quality Control Sample (SPEX) stored in freezer and sub-sample exactly 10mL into a labeled 30mL test tube to be used for QCS.

12.4 Prepare Digestion Reagent by dissolving 20.1 g Potassium persulfate and 3 g Sodium hydroxide in a 1000 mL volumetric flask:

- 12.4.2 Rinse volumetric flask with deionized water.
- 12.4.3 Add 20.1 g Potassium Persulfate directly to the volumetric flask.
- 12.4.4 Add deionized water until the meniscus is slightly below full volume.
- 12.4.5 Add 3 g Sodium Hydroxide to the persulfate and water solution, cap immediately and mix thoroughly.
- 12.4.6 Bring to volume with deionized water.
- 12.4.7 Make fresh daily.
- 12.4.8 Digestion Reagent has a shelf life of about 4 hours.

12.5 When ready to digest, thaw frozen samples at room temperature.

April 13, 2010

- 12.6 Rinse dispensing vessel with deionized water and sample rinse with digestion reagent.
- 12.7 Add thoroughly mixed digestion reagent.
- 12.8 Adjust and check dispensing vessel for desired dispensing volume.
- 12.9 Add desired amount of digestion reagent, cap tube, shake for mixing and add test tube to pressure cooker.
- 12.10 Add desired amount of digestion reagent to the standards at the beginning, middle and end of the sequence of loading the samples.
- 12.11 When all samples and standards have received digestion reagent and have been loaded into the pressure cooker, place pressure cooker on hot plate, add deionized water until tubes are 75% immersed, wet the gasket on the lid with a few drops of water and place lid on the pressure cooker.
- 12.12 Turn the hot plate on maximum temperature and have the pressure cooker come up to full steam. (This takes about 1 hour.)
- 12.13 When full steam is achieved, place the pressure regulator on the steam vent. Maintain heat for the cooker containing samples and standards at 3-4 psi for 1 hour.
- 12.14 Turn off pressure cooker and unplug the hot plate when finished. Keep the lid on the pressure cooker.
- 12.15 After samples have cooled, usually the next day, remove the pressure cooker lid, add 1 mL Borate Buffer to each tube, cap, and shake.
- 12.16 Sample batch is now ready to analyze and is stable for 1 year.

13 DATA ANALYSIS AND CALCULATIONS

- 13.1 Upon completion of all analysis, results are saved to a daily report file. The file is named by the run date. The daily report file for analytical batch of July 1, 2005 would be named 070105. The file is converted to Microsoft Excel and then to Lotus 123 for data work up. The instrument software has calculated final sample concentration from the designated standard curve, correcting each concentration for associated side wave length and also for any user or instrument specified dilution. Dilution by the instrument is noted by software as analysis ensues and, also, documented in the Excel data report file. The analyst examines each row of data. Results are eliminated that are outside the limits of the calibration range, or have an unrepeated side wave length measurement greater than 0.002 absorbance units.

14 METHOD PERFORMANCE

- 14.1 On 32 separate dates from May 2009 through February 2010, 32 replicate analyses of SPEX® Corporation QC 6-51 NUT 2 were performed by TDN Enzyme Catalized Reduction. This produced a mean value of 0.55 mg TDN as NO₃-N/L, SD 0.03, Relative Percent Difference of 4.4% from the expected value of 0.525 ± 10%. This is a mean recovery of 105%.

April 13, 2010

15 REFERENCES

- 15.1 USEPA. 1979. Method No. 353.2 *in* Methods for chemical analysis of water and wastes. United States Environmental Protection Agency, Office of Research and Development. Cincinnati, Ohio. Report No. EPA-600/4-79-020 March 1979. 460pp.
- 15.2 Campbell, et al. (2006). Nitrate reductase for nitrate analysis in water. Environ Chem Letters 4:69. <http://www.nitrate.com/ECL2006.pdf>
- 15.3 Frank, J. M., C.F. Zimmermann and C. W. Keefe (2006). Comparison of results from Konelab Aquakem 250 and existing nutrient analyzers. UMCES CBL Nutrient Analytical Services Laboratory, Dec. 2006.
- 15.4 Patton, et al. (2002). Corn leaf nitrate reductase – a nontoxic alternative to cadmium for photometric nitrate determinations in water samples by air-segmented continuous-flow analysis, Environ. Sci Tech. 2002, 36, 729-735. <http://www.nitrate.com/pattonetal2002.pdf>
- 15.5 <http://www.nitrate.com/nar-nam1.htm>

April 13, 2010

Appendix VII

Range	umoles NO ₃ /L	mg N/L	ml 1 NO ₃ std/100ml	Potassium Persulfate	Spike Conc.	Glutamic/Glycerophosphate for % Recovery	CCV
	0	0	DI H ₂ O				
Low	10	0.14	0.2	20.1 g/L and 3g/L NaOH	200 umole NO ₃	1 ml Glutamic	1.0 mL Glutamic
10 ml sample	25	0.35	0.5		12 umole PO ₄		
5 ml persulfate	35	0.49	0.7				
	50	0.70	1.0				
	75	1.05	1.5				
XHigh	0	0	DI H ₂ O		400 umole NO ₃	3 ml Glutamic	3.0 mL Glutamic
10 ml sample	25	0.35	0.5	20.1 g/L and 3g/L NaOH	12 umole PO ₄		
5 ml persulfate	50	0.70	0.7				
	75	1.05	1.5				
	100	1.4	2.0				
	150	2.1	3.0				
	200	2.8	4.0				
	400	5.6	8.0				
TWS TDN	0	0	DI H ₂ O				4 ml Glutamic
5 ml sample	150	2.1	3.0	13.4 g/2000 mL and 2 g NaOH 6.7 g/L and 1g NaOH	2.5 ml of		
15 ml persulfate	300	4.2	6.0		400 umole NO ₃ & 12 umole PO ₄		
	400	5.6	8.0		Added to 2.5 ml sample prior to digestion		
	500	7.0	10.0				

Table 1. Methods and Standards Used for TDN Enzyme Catalyzed Nitrate

April 13, 2010

April 13, 2010

Determination of Total Particulate Phosphorus (TPP) and Particulate Inorganic Phosphorus (PIP) in Fresh/Estuarine/Coastal Waters

1 SCOPE and APPLICATION

- 1.1 Total Particulate Phosphorus, Inorganic Particulate Phosphorus, and Phosphorus in algal and sediment samples are determined using this method.
- 1.2 Ammonium molybdate and potassium antimony tartrate react in an acid medium with dilute solutions of phosphorus to form an antimony-phosphomolybdate complex which is reduced to an intensely blue-colored complex by ascorbic acid. Color is proportional to phosphorus concentration. The method is used to analyze all ranges of salinity.
- 1.3 A Method Detection Limit (MDL) of 0.0021 mg P/L for Total Particulate Phosphorus was determined as three times the standard deviation of seven low level replicates.
- 1.4 A Method Detection Limit (MDL) of 0.0024 mg P/L for Particulate Inorganic Phosphorus was determined as three times the standard deviation of seven low level replicates.
- 1.5 The Quantitation Limit for TPP was set at 0.0070 mg P /L, or ten times the standard deviation of the MDL calculation.
- 1.6 The Quantitation Limit for PIP was set at 0.0080 mg P /L, or ten times the standard deviation of the MDL calculation.
- 1.7 The method is suitable for P concentrations 0.0070 to 3.72 mg PO₄-P/L.
- 1.8 This procedure should be used by analysts experienced in the theory and application of combusted, extractive particulate nutrient analysis. Three months experience with an experienced analyst, certified in the analysis of combusted, extractive particulate phosphorus analysis is required.
- 1.9 This method can be used for all programs that require analysis of particulate phosphorus.
- 1.10 The colorimetric portion of the procedure conforms to EPA Method 365.1 (1979).

2 SUMMARY

- 2.1 Samples for the measurement of Total Particulate Phosphorus are combusted, then extracted in an acidic medium.
- 2.2 Samples for the measurement of Particulate Inorganic Phosphorus are extracted in an acidic medium.
- 2.3 Extracted samples are mixed with a sulfuric acid-antimony-molybdate solution, and subsequently with an ascorbic acid solution, yielding an intense blue color suitable for photometric measurement.

3 DEFINITIONS

- 3.1 Acceptance Criteria – Specified limits placed on characteristics of an item, process, or service defined in a requirement document. (ASQC)
- 3.2 Accuracy – The degree of agreement between an observed value and an accepted reference value. Accuracy includes a combination of random error (precision) and systematic error (bias) components which are due to sampling and analytical operations; a data quality indicator. (QAMS)
- 3.3 Aliquot – A discrete, measured, representative portion of a sample taken for analysis. (EPA QAD Glossary)
- 3.4 Analytical Range – 0.007 to 3.72 mg P/L in extract. The overall analytical range of extracted samples is comprised of three distinct, yet overlapping concentration ranges. A separate calibration is performed for each range. These ranges include 0.007 to 0.744 mg P/L, 0.110 to 1.488 mg P/L and 0.372 to 3.72 mg P/L. Three sub-ranges are utilized so that extracted samples can be analyzed on the most appropriate scale possible. Final concentration of particulate phosphorus in the sample is dependent on volume filtered.
- 3.5 Batch – Environmental samples, which are prepared and /or analyzed together with the same process and personnel, using the same lot(s) of reagents. A **preparation batch** is composed of one to 200 environmental samples of the same matrix, meeting the above mentioned criteria and with a maximum time between the start of processing of the first and last sample in the batch to be 8 hours. An **analytical batch** is composed of prepared environmental samples (extracts, digestates, concentrates) and/or those samples not requiring preparation, which are analyzed together as a group using the same calibration curve or factor. An analytical batch can include samples originating from various environmental matrices and can exceed 20 samples. (NELAC/EPA)
- 3.6 Blank- A sample that has not been exposed to the analyzed sample stream in order to monitor contamination during sampling, transport, storage or analysis. The blank is subjected to the usual analytical and measurement process to establish a zero baseline or background value and is sometimes used to adjust or correct routine analytical results. (ASQC)
- 3.7 Calibrate- To determine, by measurement or comparison with a standard, the correct value of each scale reading on a device. The levels of the applied calibration standard should bracket the range of planned or expected sample measurements. (NELAC)
- 3.8 Calibration – The set of operations which establish, under specified conditions, the relationship between values indicated by a measuring device. The levels of the applied calibration standard should bracket the range of planned or expected sample measurements. (NELAC)
- 3.9 Calibration Blank – A volume of reagent water fortified with the same matrix as the calibration standards, without analyte added.
- 3.10 Calibration Curve – The graphical relationship between known values, such as concentrations, or a series of calibration standards and their analytical response. (NELAC)

- 3.11 Calibration Method – A defined technical procedure for performing a calibration. (NELAC)
- 3.12 Calibration Standard – A substance or reference material used to calibrate an instrument. (QAMS)
 - 3.12.1 Initial Calibration Standard (STD) – A series of standard solutions used to initially establish instrument calibration responses and develop calibration curves for individual target analytes.
 - 3.12.2 Initial Calibration Verification (ICV) – An individual standard, distinct from the Initial Calibration Standards (STD), analyzed initially, prior to any sample analysis, which verifies acceptability of the calibration curve or previously established calibration curve.
 - 3.12.3 Continuing Calibration Verification (CCV) – An individual standard, distinct from the Initial Calibration Standards (STD), analyzed after every 15-20 field sample analyses.
- 3.13 Certified Reference Material – A reference material one or more of whose property values are certified by a technically valid procedure, accompanied by or traceable to a certificate or other documentation which is issued by a certifying body. (ISO 17025)
- 3.14 Corrective Action – Action taken to eliminate the causes of an existing nonconformity, defect or other undesirable situation in order to prevent recurrence. (ISO 8402)
- 3.15 Deficiency – An unauthorized deviation from acceptable procedures or practices. (ASQC)
- 3.16 Demonstration of Capability – A procedure to establish the ability of the analyst to generate acceptable accuracy. (NELAC)
- 3.17 Detection Limit – The lowest concentration or amount of the target analyte that can be determined to be different from zero by a single measurement at a stated degree of confidence.
- 3.18 Duplicate Analysis – The analyses of measurements of the variable of interest performed identically on two sub samples (aliquots) of the same sample. The results from duplicate analyses are used to evaluate analytical or measurement precision but not the precision of sampling, preservation or storage internal to the laboratory. (EPA-QAD)
- 3.19 External Standard (ES) – A pure analyte (Potassium dihydrogen phosphate (KH_2PO_4)) that is measured in an experiment separate from the experiment used to measure the analyte(s) in the sample. The signal observed for a known quantity of the pure external standard is used to calibrate the instrument response for the corresponding analyte(s). The instrument response is used to calculate the concentrations of the analyte(s) in the unknown sample.
- 3.20 Field Duplicates (FD1 and FD2) – Two separate samples collected at the same time and place under identical circumstances and treated exactly the same throughout field and laboratory procedures. Analyses of FD1 and FD2

- provide a measure of the precision associated with sample collection, preservation and storage, as well as with laboratory procedures.
- 3.21 Holding time – The maximum time that samples may be held prior to analysis and still be considered valid. (40 CFR Part 136) The time elapsed from the time of sampling to the time of extraction or analysis, as appropriate.
- 3.22 Laboratory Duplicates (LD1 and LD2) – Two aliquots of the same sample taken in the laboratory and analyzed separately with identical procedures. Analyses of LD1 and LD2 indicate precision associated with laboratory procedures, but not with sample collection, preservation, or storage procedures.
- 3.23 Laboratory Reagent Blank (LRB) – A blank matrix (i.e., 1 N HCl) that is treated exactly as a sample including exposure to all glassware, equipment, solvents, and reagents that are used with other samples. The LRB is used to determine if method analytes or other interferences are present in the laboratory environment, the reagents, or the instrument.
- 3.24 Laboratory Control Sample (LCS) – A sample matrix, free from the analytes of interest, spiked with verified known amounts of analytes from a source independent of the calibration standard or a material containing known and verified amounts of analytes. The LCS is generally used to establish intra-laboratory or analyst-specific precision and bias or to assess the performance of all or a portion of the measurement system. (NELAC)
- 3.25 Limit of Detection (LOD) – The lowest concentration level that can be determined by a single analysis and with a defined level of confidence to be statistically different from a blank. (ACS)
- 3.26 Limit of Quantitation (LOQ) – The minimum levels, concentrations, or quantities of a target variable (target analyte) that can be reported with a specified degree of confidence. The LOQ is set at 3 to 10 times the LOD, depending on the degree of confidence desired.
- 3.27 Linear Dynamic Range (LDR) – The absolute quantity over which the instrument response to an analyte is linear. This specification is also referred to as the Linear Calibration Range (LCR).
- 3.28 Material Safety Data Sheets (MSDS) – Written information provided by vendors concerning a chemical's toxicity, health hazards, physical properties, fire, and reactivity data including storage, spill, and handling precautions.
- 3.29 May – Denotes permitted action, but not required action. (NELAC)
- 3.30 Method Detection Limit (MDL) – The minimum concentration of an analyte that can be identified, measured, and reported with 99% confidence that the analyte concentration is greater than zero (Standard Methods).
- 3.31 Must – Denotes a requirement that must be met. (Random House College Dictionary)
- 3.32 Photometer – measures the absorbance of the solution in the cell in a multicell cuvette. Light passes from the lamp through the condensing lenses to the interference filter. The plane surface of the first condensing lens is coated with a material which reflects heat and infrared light. The filters are mounted on a filter wheel. There are 15 positions for filters. Each filter corresponds to a wavelength of interest. The 880 nm filter is specified by the

test definition for particulate phosphorus. After passing through the filter the light is converted into a stream of light pulses by a chopper. Then the light is directed via a quartz fiber through a focusing lens and a slit to the beam divider. The beam divider divides the light into two parts. A specified portion is reflected to the reference detector, which monitors the light level fluctuations. The remaining major portion of the light beam goes through the liquid in the cell to the signal detector, which measures the amount of light absorbed.

- 3.33 Precision – The degree to which a set of observations or measurements of the same property, obtained under similar conditions, conform to themselves; a data quality indicator. Precision is usually expressed as standard deviation, variance or range, in either absolute or relative terms. (NELAC)
- 3.34 Preservation – Refrigeration, freezing, and/or reagents added at the time of sample collection (or later) to maintain the chemical and or biological integrity of the sample.
- 3.35 Quality Control Sample (QCS) – A sample of analyte of known and certified concentration. The QCS is obtained from a source external to the laboratory and different from the source of calibration standards. It is used to check laboratory performance with externally prepared test materials.
- 3.36 Run Cycle – Typically a day of operation – the entire analytical sequence from sampling the first standard to the last sample of the day.
- 3.37 Sample Segment – Bar-coded metal tray that holds up to fourteen four milliliter auto analyzer vials containing samples or standards. The user identifies each vial in the operating software.
- 3.38 Sample Segment Holder – An automated temperature controlled carousel that contains up to six sample segments. This carousel spins in clockwise or counterclockwise manner to move the sample segments into position for analysis. This carousel format allows for continuous processing.
- 3.39 Sensitivity – The capability of a test method or instrument to discriminate between measurement responses representing different levels (concentrations) of a variable of interest.
- 3.40 Shall – Denotes a requirement that is mandatory whenever the criterion for conformance with the specification requires that there be no deviation. (ANSI)
- 3.41 Should – Denotes a guideline or recommendation whenever noncompliance with the specification is permissible. (ANSI)
- 3.42 Standard Reference Material (SRM) – Material which has been certified for specific analytes by a variety of analytical techniques and/or by numerous laboratories using similar analytical techniques. These may consist of pure chemicals, buffers, or compositional standards. The materials are used as an indication of the accuracy of a specific analytical technique.
- 3.43 Test Definition – A photometric test consisting of a user defined testing sequence, reagent additions, calibration standards, incubations and absorption results.
- 3.44 Test Flow – Functions to define the parameter for reagent and sample dispensing, dilution, incubation and measurement.

4 INTERFERENCES

- 4.1 Suspended matter in the sample will scatter light as it passes through the cuvette to the detector. High blank responses will result. The identified sample will be reanalyzed.
- 4.2 Blemishes in the cuvette, as result of the manufacturing process, will result in high blank responses. The identified sample will be reanalyzed.
- 4.3 Silicon (Si) at analysis temperature $>40^{\circ}\text{C}$ and/or <2.2 N Sulfuric Acid in the Triple Reagent solution causes interference in the concentration range > 0.05 mg/mL Si in the extract. High silica concentrations cause positive interference. These conditions are avoided by maintaining an acid concentration of 2.45 N Sulfuric Acid in the reagents and analysis at 37°C .

5 SAFETY

- 5.1 Safety precautions must be taken when handling reagents, samples and equipment in the laboratory. Protective clothing including lab coats, safety glasses and enclosed shoes should be worn. In certain situations, it will be necessary to also use gloves and/or a face shield. If solutions come in contact with eyes, flush with water continuously for 15 minutes. If solutions come in contact with skin, wash thoroughly with soap and water. Contact Solomons Rescue Squad (911) if emergency treatment is needed and also inform the CBL Business Manager of the incident. Contact the CBL Business Manager if additional treatment is required.
- 5.2 The toxicity or carcinogenicity of each reagent used in this procedure may not have been fully established. Each chemical should be regarded as a potential health hazard and exposure should be as low as reasonably achievable. Cautions are included for known hazardous materials and procedures.
- 5.3 Do not wear jewelry when troubleshooting electrical components. Even low voltage points are dangerous and can injure if allowed to short circuit.
- 5.4 The following hazard classifications are listed for the chemicals used in this procedure. Detailed information is provided on Material Safety Data Sheets (MSDS).

Chemical	Health	Flammability	Reactivity	Contact	Storage
Hydrochloric Acid	3	0	2	4	White
Sulfuric Acid	4	0	2	4	White
Ammonium Molybdate	2	0	1	2	Orange
Potassium Antimonyl Tartrate hemihydrate	3	1	1	2	Blue
Ascorbic Acid	1	1	0	1	Orange
Potassium dihydrogen phosphate	1	0	0	1	Green
Chloroform	3	1	1	3	Blue
Clorox	3	0	2	4	White

On a scale of 0 to 4 the substance is rated on four hazard categories: health, flammability, reactivity, and contact. (0 is non-hazardous and 4 is extremely hazardous)

STORAGE

Red – Flammability Hazard: Store in a flammable liquid storage area.

Blue – Health Hazard: Store in a secure poison area.

Yellow – Reactivity Hazard: Keep separate from flammable and combustible materials.

White – Contact Hazard: Store in a corrosion-proof area.

Green – Use general chemical storage (On older labels, this category was orange).

Striped – Incompatible materials of the same color class have striped labels. These products should not be stored adjacent to substances with the same color label. Proper storage must be individually determined.

6 EQUIPMENT AND SUPPLIES

- 6.1 Filtering apparatus
- 6.2 Glass fiber filters. This laboratory uses Whatman GF/F (47 mm, 0.7 μm pore size) filter pads for water samples.
- 6.3 Foil pouches, labeled with sample identification and volume filtered
- 6.4 Flat-bladed forceps
- 6.5 Freezer, capable of maintaining $-20^{\circ} \pm 5^{\circ}\text{C}$.
- 6.6 Drying oven. This laboratory uses Lindberg/Blue M Drying Oven
- 6.7 Crucibles and lids for combusting filter pads; a separate set of crucibles and lids for combusting sediments and algae
- 6.8 Muffle furnace. This laboratory uses a ThermoLyne 30428 combustion oven set at 500°C to obtain a true combustion temperature of 550°C .
- 6.9 Analytical balance accurate to 0.0001 g for weighing sediment and algae
- 6.10 AutoAnalyzer cups and racks to hold them
- 6.11 Lab ware: 50 mL plastic centrifuge tubes with screw caps
- 6.12 1 digital timer
- 6.13 1 re-pipettor
- 6.14 Lab ware – All reusable lab ware (glass, Teflon, plastic, etc) should be sufficiently clean for the task objectives. This laboratory cleans all lab ware related to this method with a 10% HCl (v/v) acid rinse. This laboratory cleans all lab ware that has held solutions containing ammonium molybdate with 10% NaOH (w/v) rinse.
- 6.15 Aqaukem 250 multi-wavelength automated discrete photometric analyzer. Aqaukem 250 control software operates on a computer running Microsoft Windows NT or XP operating system.

7 REAGENTS AND STANDARDS

- 7.1 Purity of Water – Unless otherwise indicated, references to water shall be understood to mean reagent water conforming to Specification D 1193, Type I. Freshly prepared water should be used for making the standards intended for

calibration. The detection limits of this method will be limited by the purity of the water and reagents used to make the standards.

7.2 Purity of Reagents – Reagent grade chemicals shall be used in all tests. Unless otherwise indicated, it is intended that all reagents shall conform to specifications of the Committee on Analytical Reagents of the American Chemical Society, where such specifications are available. Other grades may be used, provided it is first ascertained that the reagent is of sufficiently high purity to permit its use without compromising the accuracy of the determination.

7.3 1 N Hydrochloric acid

Hydrochloric acid (concentrated) 86mL

In a 1000mL volumetric flask add approximately 800 mL deionized water. Add 86 mL concentrated HCl to the deionized water, cool, and bring to volume. Write name of preparer, preparation date, reagent manufacturer, manufacturer's lot number in the Analytical Reagent log book. Store the flask at room temperature. Reagent is stable for one year.

7.4 9.8 N Sulfuric acid

Sulfuric acid (concentrated) 54.4 mL

In a 200 mL volumetric flask add approximately 120 mL deionized water. Add 54.4 mL H₂SO₄ to the deionized water, cool, and bring to volume. Write name of preparer, preparation date, reagent manufacturer, manufacturer's lot number in the Analytical Reagent log book. Store the flask at room temperature. Reagent is stable for one year.

7.5 Ammonium molybdate solution

Ammonium molybdate 8.0 g

In a 100 mL plastic volumetric flask dissolve, with immediate inversion, 8.0 g Ammonium molybdate, in approximately 90 mL deionized water. Bring flask to volume. Store flask in dark at room temperature. Write name of preparer, preparation date, reagent manufacturer, manufacturer's lot number in the Analytical Reagent log book. Reagent is stable for one month. Discard if white precipitate appears in flask or on threads of cap.

7.6 Potassium antimonyl tartrate solution

Potassium antimonyl tartrate 0.6 g

In a 100 mL plastic volumetric flask dissolve 0.6 g Potassium antimonyl tartrate hemihydrate, in approximately 90 mL deionized water. Bring flask to volume. Store flask at room temperature. Write name of preparer, preparation date, reagent manufacturer, manufacturer's lot number in the Analytical Reagent log book. Reagent is stable for one year.

7.7 Ascorbic acid solution

Ascorbic acid 3.6 g

In a 100 mL plastic volumetric flask dissolve 3.6g Ascorbic acid, in approximately 90 mL deionized water. Bring flask to volume. Store flask in refrigerator. Write name of preparer, preparation date, reagent manufacturer, manufacturer's lot number in the Analytical Reagent log book. Reagent is stable for two months.

7.8 Triple Reagent -

9.8 N Sulfuric acid 40 mL

Ammonium molybdate solution 12 mL

Potassium antimonyl tartrate solution 4.0 mL

Add 40 mL 9.8 N Sulfuric acid to a 60 mL reagent container. Carefully add 12 mL Ammonium molybdate solution to the reagent container. Carefully add 4.0 mL Potassium antimonyl tartrate solution to the reagent container. Cap. Invert six times to mix. Write name of preparer, preparation date, constituent solutions' preparation dates in the Analytical Reagent log book. Reagent is stable for two weeks.

7.9 Orthophosphate Stock Standard, 12,000 μM –

Potassium dihydrogen phosphate (KH_2PO_4), primary standard grade, dried at 45°C 1.632 g

In a 1 L volumetric flask, dissolve 1.632 g of potassium dihydrogen phosphate in approximately 800 mL deionized water. Bring flask to volume with deionized water (1 mL contains 12 $\mu\text{moles P}$). Add 1 mL chloroform as a preservative. Write name of preparer, preparation date, standard manufacturer, manufacturer lot number in the Analytical Standard log book. Make fresh every 6 months.

7.10 Working Low Orthophosphate in HCl Standard –

Stock Orthophosphate standard 0.20 mL

In a 100 mL volumetric flask, dilute 0.20 mL of Stock Orthophosphate Standard to volume with 1 N HCl to yield a concentration of 24 $\mu\text{M PO}_4\text{-P/L}$ (0.744mg P/L). Write name of preparer, preparation date, Stock Standard preparation date in the Analytical Standard log book. Make fresh every month.

7.11 Working Mid Range Orthophosphate in HCl Standard –

Stock Orthophosphate Standard 0.40 mL

In a 100 mL volumetric flask, dilute 0.40 mL of Stock Orthophosphate Standard to volume with 1 N HCl to yield a concentration of 48 $\mu\text{M PO}_4\text{-P/L}$ (1.488 mg P/L). Write name of preparer, preparation date, Stock Orthophosphate Standard preparation date in the Analytical Standard log book. Make fresh every month.

7.12 Working High Orthophosphate in HCl Standard –

Stock Orthophosphate Standard 1.00 mL

In a 100 mL volumetric flask, dilute 1.00 mL of Stock Orthophosphate Standard to volume with 1 N HCl to yield a concentration of 12.0 $\mu\text{M PO}_4\text{-P/L}$ (3.72 mg P/L). Write name of preparer, preparation date, Stock Orthophosphate Standard preparation date in the Analytical Standard log book. Make fresh every month.

7.13 Aquakem Cleaning Solution –

Clorox 75.0 mL

In a 100 mL volumetric flask, dilute 75.0 mL of Clorox to volume with deionized water to yield a concentration of 75% Clorox. Write name of preparer, preparation date, reagent manufacturer, manufacturer lot number in the Analytical Reagent log book. Reagent is stable for six months.

8 SAMPLE COLLECTION, PRESERVATION, AND STORAGE

8.1 Total Particulate Phosphorus Water Samples

- 8.1.1 Water samples for total particulate phosphorus are filtered. If filtering is delayed more than one hour, the water samples are iced in a cooler or refrigerated until filtered.
- 8.1.2 For each sample, a recorded volume of water is filtered through a 47 mm Whatman GF/F filter pad. After filtering, the pad is folded in half using forceps. This folding maintains the integrity of the particulate matter concentrated on the pad.
- 8.1.3 The pad containing the sample is placed in a labeled foil pouch. The label identifies the sample, sampling date and volume filtered.
- 8.1.4 Freeze samples at $-20^{\circ} \pm 5^{\circ}$ C.
- 8.1.5 Fold blank filter pads in half and place in a labeled foil pouch.
- 8.1.6 Freeze blank filter pads at $-20^{\circ} \pm 5^{\circ}$ C.

8.2 Particulate Inorganic Phosphorus Water Samples

- 8.2.1 Water samples for total particulate phosphorus are filtered. If filtering is delayed more than one hour, the water samples are iced in a cooler or refrigerated until filtered.
- 8.2.2 For each sample, a recorded volume of water is filtered through a 47 mm Whatman GF/F filter pad that has been pre-combusted at 500°C for 90 minutes. After filtering, the pad is folded in half using forceps. This folding maintains the integrity of the particulate matter concentrated on the pad.
- 8.2.3 The pad containing the sample is placed in a labeled foil pouch. The label identifies the sample, sampling date and volume filtered.
- 8.2.4 Freeze samples at $-20^{\circ} \pm 5^{\circ}$ C.
- 8.2.5 Fold blank filter pads in half and place in a labeled foil pouch.
- 8.2.6 Freeze blank filter pads at $-20^{\circ} \pm 5^{\circ}$ C.

8.3 Algae and sediment samples

- 8.3.1 Samples are dried overnight at 50°C , then ground to uniform powdery consistency and placed in labeled, capped vials.

8.4 Frozen samples may be stored up to 28 days. It has been shown that frozen QCS samples up to a year old still fall well within the control limits.

9 QUALITY CONTROL

9.1 The laboratory is required to operate a formal quality control (QC) program. The minimum requirements of this program consist of an initial demonstration of laboratory capability and the continued analysis of laboratory instrument blanks and calibration standard material, analyzed as samples, as a continuing check on performance. The laboratory is required to maintain performance records that define the quality of data generated.

9.2 Initial Demonstration of Performance

- 9.2.1 The initial demonstration of capability (phosphorus) – is used to characterize instrument performance (MDLs) and laboratory performance (analysis of QC samples) prior to the analyses conducted by this procedure.
- 9.2.2 Linear Dynamic Range – LDR (Linear Calibration Range) should be established for phosphorus using appropriate seven point calibration curve.
- 9.2.3 Quality Control Sample (QCS/SRM) – When using this procedure, a quality control sample is required to be analyzed at the beginning and end of the run, to verify data quality and acceptable instrument performance. If the determined concentrations are not within $\pm 10\%$ of the certified values, performance of the determinative step of the method is unacceptable. The source of the problem must be identified and corrected before either proceeding with the initial determination of MDLs or continuing with analyses.
- 9.2.4 Method Detection Limits (MDLs) – MDLs should be established for phosphorus using a low level ambient water sample. To determine the MDL values, filter and analyze particulate portion of seven replicate aliquots of water. Perform all calculations defined in the procedure (Section 12) and report the concentration values in the appropriate units. Calculate the MDL as follows:
- $$\text{MDL} = s \times 3$$
- Where, s = Standard Deviation of the replicate analyses.
- 9.2.5 MDLs shall be determined yearly and whenever there is a significant change in instrument response, a significant change in instrument configuration, or a new matrix is encountered.

9.3 Assessing Laboratory Performance

- 9.3.1 Laboratory Reagent Blank (LRB) – The laboratory must analyze at least one LRB with each batch of samples. The LRB consists of 1 N HCl treated the same as the samples. Analyte found in LRB indicates possible reagent or laboratory environment contamination. LRB data are used to assess and correct contamination from the laboratory environment. LRB above the lowest standard requires that the source of the problem must be identified and corrected before proceeding with analyses.
- 9.3.2 Quality Control Sample (QCS)/ Standard Reference Material (SRM) – When using this procedure, a quality control sample is required to be analyzed at the beginning of the run and end of the run, to verify data quality and acceptable instrument performance. If the determined concentrations are not within $\pm 3s$ of the certified values, performance of the determinative step of the method is unacceptable. The source of the problem must be identified and corrected before either proceeding with

the initial determination of MDLs or continuing with the analyses. The results of these QCS/SRM samples shall be used to determine batch acceptance.

- 9.3.3 The QCS are obtained from a source external to the laboratory and different from the source of calibration standards.
- 9.3.4 Control Charts – The Accuracy Control Chart for QCS/SRM samples is constructed from the average and standard deviation of the 20 most recent QCS/SRM measurements. The accuracy chart includes upper and lower warning levels ($WL=\pm 2s$) and upper and lower control levels ($CL=\pm 3s$). These values are derived from stated values of the QCS/SRM. The standard deviation (s) is specified relative to statistical confidence levels of 95% for WLs and 99% for CLs. Set up an accuracy chart by using percent recovery since the concentration of the QCS/SRM varies. Enter QCS/SRM results on the chart each time the sample is analyzed.
- 9.3.5 Continuing Calibration Verification (CCV) – Following every 18-23 samples, one CCV of 18 $\mu\text{M PO}_4\text{-P/L}$ (0.558 mg P/L) PPLOW, 36 $\mu\text{M PO}_4\text{-P/L}$ (1.116 mg P/L) PP, 96 $\mu\text{M PO}_4\text{-P/L}$ (2.976 mg P/L) PPHIGH is analyzed to assess instrument performance. The CCVs are made from the same material as calibration standards (KH_2PO_4), and are to be within $TV \pm 3s$. Failure to meet the criteria requires correcting the problem, including reanalysis of any affected samples. If not enough sample exists, the data must be qualified if reported.
- 9.3.6 Reagent Blank – The Reagent Blank Control Chart for Reagent Blank, composed of 1 N HCl samples, is constructed from the average and standard deviation of the 20 most recent Reagent Blank measurements. The accuracy chart includes upper and lower warning levels ($WL=\pm 2s$) and upper and lower control levels ($CL=\pm 3s$). The standard deviation (s) is specified relative to statistical confidence levels of 95% for WLs and 99% for CLs. Enter Reagent Blank results on the chart each time the Reagent Blank is analyzed.
- 9.4 Assessing Analyte Recovery - % Recovery
- 9.4.1 Analyte recovery is assessed through percent recoveries of laboratory spikes of samples.
- 9.4.2 $\% \text{ Recovery} = (\text{Spiked sample concentration} - \text{Sample concentration} / \text{Concentration of spike solution}) \times 100$
- 9.5 Assessing Analyte Precision – Relative Percent Difference
- 9.5.1 Analyte replication is assessed through duplicate analyses of samples – Relative Percent Difference.
- 9.5.2 $\text{RPD} = (\text{Laboratory Duplicate Result 1} - \text{Laboratory Duplicate Result 2}) / [(\text{Laboratory Duplicate Result 1} + \text{Laboratory Duplicate Result 2}) / 2] \times 100$.
- 9.6 Corrective Actions for Out of Control Data
- 9.6.1 Control limit – If one measurement exceeds Accuracy Control Chart CL, repeat the analysis immediately. If the repeat measurement is within the

CL, continue analyses; if it exceeds the CL, discontinue analyses and correct the problem.

- 9.6.2 Warning limit – If two out of three successive points exceed Accuracy Control Chart WL, analyze another sample. If the next point is within WL, continue analyses; if the next point exceeds the WL, evaluate potential bias and correct the problem.
- 9.6.3 Trending – If seven successive Accuracy Control Chart measurements are on the same side of the central line, discontinue analyses and correct the problem.
- 9.6.4 When external QCS samples are out of control, correct the problem. Reanalyze the samples analyzed between the last in-control measurement and the out-of-control one.
- 9.6.5 When external CCV samples are out of control, correct the problem. Reanalyze the samples analyzed between the last in-control measurement and the out-of-control one.

9.7 General Operation - To assure optimal operation and analytical results, the Reagent Blank and CCV are tracked daily in the raw data file, copied to Reagent Blank and CCV Control Charts.

10 CALIBRATION AND STANDARDIZATION

10.1 Calibration – Daily calibration must be performed before sample analysis may begin. Six point calibrations are used with each of the three sub-calibrations that cover the analytical range. Three working orthophosphate standards in HCl are used to produce the calibrators for each set of three calibration curves. The instrument performs serial dilutions of working standards to produce the six calibrators defined for each curve. The following outlines the preparation of the working standards and the following table describes the subsequent serial dilutions the instrument performs to make each standard for each of the three calibration curves.

Orthophosphate Working Standards:

PPLOWCBL

Working Standard	0.744 mg P/L	(0.20 mL stock to 100 mL)
Working CCV	0.558mg P/L	(0.15 mL stock to 100 mL)

PPCBL

Working Standard	1.488 mg P/L	(0.4 mL stock to 100 mL)
Working CCV	1.116 mg P/L	(0.3 mL stock to 100 mL)

PPHIGH

Working Standard	3.720 mg P/L	(1.0 mL stock to 100 mL)
Working CCV	2.976 mg P/L	(0.8 mL stock to 100 mL)

Orthophosphate Calibrators:

Test Name	Working Standard	Dilution Factor	Concentration mg P/L
PLOWCBL	0.744 mg P/L	1+12	0.0572
	0.744 mg P/L	1+9	0.0744
	0.744 mg P/L	1+6	0.1063
	0.744 mg P/L	1+3	0.186
	0.744 mg P/L	1+2	0.248
	0.744 mg P/L	1+1	0.372
	0.744 mg P/L	1+0	0.744
PPCBL	1.488 mg P/L	1+9	0.1488
	1.488 mg P/L	1+4	0.2976
	1.488 mg P/L	1+3	0.372
	1.488 mg P/L	1+2	0.496
	1.488 mg P/L	1+1	0.744
	1.488 mg P/L	1+0	1.488
	PPHIGH	3.72 mg P/L	1+6
3.72 mg P/L		1+4	0.744
3.72 mg P/L		1+3	0.93
3.72 mg P/L		1+2	1.24
3.72 mg P/L		1+1	1.86
3.72 mg P/L		1+0	3.72

- 10.2 The instrument software prepares a standard curve for each set of calibrators. A graph plotting measured absorbance against standard concentration is presented for review and approval. If acceptance criteria are not met the entire curve can be reanalyzed or individual standards can be reanalyzed. One standard value (original or reanalyzed) for each and every standard is incorporated in the curve. The coefficient of determination (Person's r value) for the calibration curve as well as the calculated concentration of each calibrator is reviewed. The calculated value of each calibrator must be within ten percent of the expected value. The coefficient of determination (Person's r value) for the calibration curve must be greater than 0.980.

11 PROCEDURE – DAILY OPERATIONS QUALITY CONTROL

- 11.1 Total Particulate Phosphorus Combustion and Extraction
- 11.1.1 Remove samples on filter pads from freezer. Open aluminum foil pouches containing the samples slightly to allow air circulation and dry in drying oven overnight at 95°C.

- 11.1.2 Place dried filter pads in labeled Coors crucibles, recording crucible number, sample identification number and volume filtered on data sheet. Data sheet example is attached. Cover with lids. Combust at setting of 500°C for 90 minutes. For this laboratory's muffle furnace, this setting has been determined to produce 550 °C.
- 11.1.3 Cool to room temperature. Transfer combusted pads to numbered 50 mL plastic screw cap centrifuge tubes whose numbers correspond to Coors crucible numbers.
- 11.1.4 Using re-pipettor, add 10 mL 1 N HCl to each centrifuge tube. Screw on cap.
- 11.1.5 After minimum of 24 hours, shake each sample.
- 11.1.6 After minimum of 24 hours, transfer an aliquot of each sample to a labeled AutoAnalyzer cup for analysis that day.
- 11.2 Particulate Inorganic Phosphorus Extraction
 - 11.2.1 Remove samples on pre-combusted filter pads from freezer. Open aluminum foil pouches containing the samples slightly to allow air circulation and dry in drying oven overnight at 95°C.
 - 11.2.2 Transfer dried pads to numbered 50 mL plastic screw cap centrifuge tubes, recording sample identification number and volume filtered on data sheet. Data sheet example is attached.
 - 11.2.3 Using re-pipettor, add 10 mL 1 N HCl to each centrifuge tube. Screw on cap.
 - 11.2.4 After a minimum of 24 hours, shake each sample.
 - 11.2.5 After a minimum of 24 hours, transfer an aliquot of each sample to a labeled AutoAnalyzer cup for analysis that day.
- 11.3 Total Algal or Sediment Phosphorus Combustion and Extraction
 - 11.3.1 Place vials containing ground algae or sediment samples in drying oven at 50°C overnight with their screw caps loosened slightly.
 - 11.3.2 Remove from drying oven, tighten screw caps.
 - 11.3.3 After samples reach room temperature, weigh approximately 25 mg of each sample into labeled Coors crucibles, recording crucible number, sample identification number and sample weight on data sheet. Data sheet example is attached. Cover with lids. Combust at setting of 500°C for 90 minutes. For this laboratory's muffle furnace, this setting has been determined to produce 550 °C.
 - 11.3.4 Cool to room temperature. Transfer combusted samples to numbered 50 mL plastic screw cap centrifuge tubes whose numbers correspond to Coors crucible numbers. Using re-pipettor, add 10 mL 1 N HCl to each crucible and pour quantitatively into centrifuge tube. Again, using re-pipettor, add 10 mL 1 N HCl to each crucible and pour quantitatively into centrifuge tube. Screw on cap. Sample is in a total of 20 mL 1N HCl.
 - 11.3.5 After a minimum of 24 hours, shake each sample.
 - 11.3.6 After a minimum of 24 hours, transfer an aliquot of each sample to a labeled AutoAnalyzer cup for analysis that day.

- 11.4 Turn on computer. Computer will automatically initiate Konelab software. Once software is running, turn on instrument and allow connection between instrument and computer to complete.
- 11.5 Discard any water remaining in the water reservoir from the previous analytical run. Fill the water reservoir with fresh deionized water.
- 11.6 Begin daily bench sheet documentation.
- 11.7 Once water reservoir is full, “perform washes” – complete five wash cycles and then initiate “start-up” at main menu.
- 11.8 Gather working standards and reagents from refrigerator during startup. Assess standards and reagents. Remake anything that has exceeded the time over which it is considered stable.
- 11.9 Once startup is complete, check that the instrument water blank of water from the reservoir has performed within acceptance limits. If any of the instrument functions are outside their predefined and software controlled limits, the user will be notified on the main menu page. User takes corrective action to return instrument functions to controlled limits.
- 11.10 Load reagents in specified position in reagent carousel and place in refrigerated reagent compartment.
- 11.11 Load working standards in a sample segment, identify the standards in their positions from the drop down menus at the individual segment positions, and load into instrument.
- 11.12 Select the methods to be calibrated. Three methods will be calibrated – PPLOW, PPCBL and PPHIGH are the method names to be selected in the software.
- 11.13 Begin calibration – See test flow below for stepwise instrument functions for the analysis of standards and samples.

Test Flow – Method of Analysis, Stepwise

- 150 µL deionized water to cuvette with mixing
- 15 µL sample to cuvette with mixing
- Blank response measurement at 880 nm
- 14 µL Triple Reagent to cuvette with mixing
- 7 µL Ascorbic Acid Reagent to cuvette with mixing
- Incubation, 600 seconds, 37°C
- End point absorbance measurement, 880 nm
- Software processes absorbance value, blank response value and uses calibration curve to calculate analyte concentration (mg P/L as PO₄)
- User is notified if any measured values used to calculate final concentration are outside preset limits. If so, analyst has options to accept result, rerun the sample or rerun the sample diluted to a user or software specified factor.
- User is notified of each blank response value. Blank response >0.001 absorbance units indicates a scratched cuvette or turbid sample. If the blank response value exceeds 0.001 absorbance units, the analyst specifies that the sample is reanalyzed. If the blank response value of the reanalyzed sample is <0.001 absorbance units, the reanalyzed

- result is accepted. If the same concentration and blank response value >0.001 absorbance units is again obtained, the results are accepted.
- 11.14 Organize samples, reagent blanks, filter blanks, check standards and all quality control samples while instrument performs calibrations.
 - 11.15 As calibration curves are produced by the instrument, review them for acceptability. The instrument software prepares a standard curve for each set of calibrators. A graph plotting measured absorbance against standard concentration is presented for review and approval. If acceptance criteria are not met, either the entire curve shall be reanalyzed or individual standards shall be reanalyzed, depending on the violation. One standard value (original or reanalyzed) for each and every calibrator is incorporated in the curve.
 - 11.16 Once calibration curves are accepted, samples are loaded into the sample segments and loaded into the instrument for analysis. After the Reagent Blank, the first sample analyzed should be an ICV (initial calibration verification) sample. There should be one ICV sample for each calibration curve, of a concentration close to the middle of each range. The following are the usual ICV samples for each curve: 0.558 mg P/L for PPLOW, 1.116 mg P/L for PPCBL and 2.976 mg P/L for PPHIGH.
 - 11.17 Samples are loaded into the segments and analyzed. CCV (Continuing Calibration Verification) samples (one for each of the three calibration ranges) follow every 18-23 samples. Standard Reference Material (SRM) samples, as well as Laboratory Reagent Blanks (LRB) are scattered throughout the analytical batch. Throughout the analytical batch, samples are chosen as Laboratory Duplicates and Laboratory Spikes to assess analyte precision and analyte recovery, respectively. The total number of duplicates and spikes performed will be equal to or greater than ten percent of the total number of samples in the analytical batch.
 - 11.18 As sample analysis is complete, results must be reviewed and accepted manually. If results fall outside acceptance limits, the sample should be reanalyzed. If sample result exceeds the highest standard of the calibration range it was run within, the samples can be automatically diluted by the instrument and reanalyzed. If the result is such that it will fall within a higher calibration range, it should be reanalyzed in that range. If the result is such that it will fall within a lower calibration range, it should be reanalyzed within that range.
 - 11.19 Upon completion of all analysis, results are saved to a daily report file. The file is named by the run date. The daily report file for analytical batch of January 1, 2005 would be named 010105. The file is converted to Microsoft Excel for data work up. Remaining samples are discarded.
 - 11.20 All reagents are removed from the reagent chamber and returned to the refrigerator. Reagents that have exceeded their stability period are discarded.
 - 11.21 Aquakem Cleaning Solution is inserted into the instrument and shut down procedures are initiated. Daily files are cleared from the instrument software, the software is exited and the instrument is shut down. The computer is shut down.
 - 11.22 The waste is flushed down the drain with copious amounts of tap water. The waste cuvette box is moved to the fume hood.

12 DATA ANALYSIS AND CALCULATIONS

- 12.1 Upon completion of all analysis, results are saved to a daily report file. The file is named by the run date. The daily report file for analytical batch of January 1, 2005 would be named 010105. The file is converted to Microsoft Excel for data work up. The instrument software has calculated final “Raw” sample concentration (uncorrected for sample volume filtered, and uncorrected for filter pad or 1N HCl Blank) in mg P/L from the designated standard curve, and also correcting each concentration for its associated blank response and any user or instrument specified dilution. Dilution by the instrument is noted by software as analysis ensues and, also, documented in the Excel data report file. The analyst examines each row of data. Results are eliminated that are outside the limits of the calibration range, or have an unrepeated blank response measurement greater than 0.001 absorbance units.
- 12.2 Calculate concentration of Total Particulate Phosphorus or Particulate Inorganic Phosphorus on filter pads from “Raw” sample concentration in mg P/L, normalizing for volume filtered and extraction in 10 mL 1 N HCl:

$$\text{mg P/L} = \frac{(\text{“Raw” Sample mg P/L} - \text{Filter Pad Blank mg P/L}) \times 0.01 \text{ L}}{(\text{mL Filtered}/1000 \text{ mL})}$$
- 12.3 Calculate % Phosphorus in Algae or Sediment Samples from “Raw” sample concentration, normalizing for sample weight and extraction in 20 mL 1N HCl:

$$\% \text{ P} = \frac{[(\text{“Raw” Sample mg P/L} - 1 \text{ N H Cl Blank mg P/L}) \times 0.02 \text{ L}] \times 100}{\text{Sample weight in mg}}$$

13 REFERENCES

- 13.1 Aspila, I., H. Agemian and A.S.Y. Chau. 1976. A semi-automated method for the determination of inorganic, organic and total phosphate in sediments. *Analyst* 101: 187-197.
- 13.2 Keefe, C.W. 1994. The contribution of inorganic compounds to the particulate carbon, nitrogen, and phosphorus in suspended matter and surface sediments of Chesapeake Bay. *Estuaries* 17:122-130.
- 13.3 USEPA. 1979. Method No. 365.1 *in* Methods for chemical analysis of water and wastes. United States Environmental Protection Agency, Office of Research and Development. Cincinnati, Ohio. Report No. EPA-600/4-79-020 March 1979. 460pp.
- 13.4 Frank, J. M., C.F. Zimmermann and C. W. Keefe (2006). Comparison of results from Konelab Aquakem 250 and existing nutrient analyzers. UMCES CBL Nutrient Analytical Services Laboratory, Dec. 2006.

Determination of Total Suspended Solids (TSS) and Total Volatile Solids (TVS) in Waters of Fresh/Estuarine/Coastal Waters .

1. SCOPE and APPLICATION

- 1.1 Gravimetric analysis is used to determine total suspended solids (TSS) and total volatile solids (TVS), also known as volatile suspended solids (VSS) using a four place analytical balance.
- 1.2 A Method Detection Limit (MDL) of 2.4 mg/L TSS, and 0.9 mg/L TVS was determined using 3X the standard deviation of 7 replicates.
- 1.3 The quantitation limit for TSS was set at 0.0005 mg/L TSS.
- 1.4 This procedure should be used by analysts experienced in the theory and application of TSS. 1 month experience with an experienced analyst, certified in the analysis using the four place balance, is required.
- 1.5 This method can be used for all programs that require analysis of total suspended and volatile solids.
- 1.6 This procedure conforms to EPA Method 160.2 and Standard Methods 208 E.

2. SUMMARY

- 2.1 Measured aliquots of a water sample are filtered through a pre-weighed glass fiber filter pad. These pads are placed into a 105° C drying oven overnight to remove any remaining water. The pads are removed from the oven and placed into a desiccator to cool to room temperature. Once samples have reached room temperature, they are individually weighed on a four place balance and their respective weights are recorded in a spreadsheet and the concentration is reported as mg/L total suspended solids. If samples are to be used to determine total volatile solids they are placed into a numbered porcelain crucible and dried in a muffle furnace at 550° C for 1.5 hours. The samples are placed into a desiccator to cool to room temperature. Once they have cooled, they are weighed on the four place balance and their weights are recorded into the spreadsheet.

3. DEFINITIONS

- 3.1 Acceptance Criteria – Specified limits placed on characteristics of an item, process, or service defined in a requirement document. (ASQC)
- 3.2 Accuracy – The degree of agreement between an observed value and an accepted reference value. Accuracy includes a combination of random error (precision) and systematic error (bias) components which are due to sampling and analytical operations; a data quality indicator. (QAMS)
- 3.3 Aliquot – A discrete, measured, representative portion of a sample taken for analysis. (EPA QAD Glossary)
- 3.4 Analytical Range - 100 ppb - 4000 ppm using 250 µl syringe and 4 - 100 µl injection volume, using regular sensitivity catalyst.

- 3.5 Batch – Environmental samples, which are prepared and /or analyzed together with the same process and personnel, using the same lot(s) of reagents. A **preparation batch** is composed of one to 20 environmental samples of the same matrix, meeting the above mentioned criteria and with a maximum time between the start of processing of the first and last sample in the batch to be 24 hours. An **analytical batch** is composed of prepared environmental samples (extracts, digestates, or concentrates) and/or those samples not requiring preparation, which are analyzed together as a group using the same calibration curve or factor. An analytical batch can include samples originating from various environmental matrices and can exceed 20 samples. (NELAC/EPA)
- 3.6 Blank- A sample that has not been exposed to the analyzed sample stream in order to monitor contamination during sampling, transport, storage or analysis. The blank is subjected to the usual analytical and measurement process to establish a zero baseline or background value and is sometimes used to adjust or correct routine analytical results. (ASQC)
- 3.7 Calibrate- To determine, by measurement or comparison with a standard, the correct value of each scale reading on a meter or other device, or the correct value for each setting of a control knob. The levels of the applied calibration standard should bracket the range of planned or expected sample measurements. (NELAC)
- 3.8 Calibration – The set of operations which establish, under specified conditions, the relationship between values indicated by a measuring device. The levels of the applied calibration standard should bracket the range of planned or expected sample measurements. (NELAC)
- 3.9 Calibration Curve – The graphical relationship between known values, such as concentrations, or a series of calibration standards and their analytical response. (NELAC)
- 3.10 Calibration Method – A defined technical procedure for performing a calibration. (NELAC)
- 3.11 Calibration Standard – A substance or reference material used to calibrate an instrument. (QAMS)
- 3.11.1 Initial Calibration Standard (STD) – A series of standard solutions used to initially establish instrument calibration responses and develop calibration curves for individual target analytes.
- 3.11.2 Initial Calibration Verification (ICV) – An individual standard, analyzed initially, prior to any sample analysis, which verifies acceptability of the calibration curve or previously established calibration curve.
- 3.11.3 Continuing Calibration Verification (CCV) – An individual standard which is analyzed after every 10-15 field sample analysis.

Corrective Action – Action taken to eliminate the causes of an existing nonconformity, defect or other undesirable situation in order to prevent recurrence. (ISO 8402)

- 3.12 Deficiency – An unauthorized deviation from acceptable procedures or practices. (ASQC)

- 3.13 Demonstration of Capability – A procedure to establish the ability of the analyst to generate acceptable accuracy. (NELAC)
- 3.14 Detection Limit – The lowest concentration or amount of the target analyte that can be determined to be different from zero by a single measurement at a stated degree of confidence.
- 3.15 Duplicate Analysis – The analyses of measurements of the variable of interest performed identically on two sub samples (aliquots) of the same sample. The results from duplicate analyses are used to evaluate analytical or measurement precision but not the precision of sampling, preservation or storage internal to the laboratory. (EPA-QAD)
- 3.16 Field Duplicates (FD1 and FD2) – Two separate samples collected at the same time and place under identical circumstances and treated exactly the same throughout field and laboratory procedures. Analyses of FD1 and FD2 provide a measure of the precision associated with sample collection, preservation and storage, as well as with laboratory procedures.
- 3.17 Field Reagent Blank (FRB) – A aliquot of reagent water or other blank matrix that is placed in a sample container in the laboratory and treated as a sample in all respects, including shipment to the sampling site, exposure to the sampling site conditions, storage, preservation, and all analytical procedures. The purpose of the FRB is to determine if method analytes or other interferences are present in the field environment.
- 3.18 Furnace – Combusts samples at 550°C.
- 3.19 Holding time – The maximum time that samples may be held prior to analysis and still be considered valid.(40 CFR Part 136) The time elapsed from the time of sampling to the time of extraction or analysis, as appropriate.
- 3.20 Instrument Detection Limit (IDL) – The minimum quantity of analyte of the concentration equivalent which gives an analyte signal equal to three times the standard deviation of the background signal at the selected wavelength, mass, retention time absorbance line, etc.
- 3.21 Laboratory Duplicates (LD1 and LD2) – Two aliquots of the same sample taken in the laboratory and analyzed separately with identical procedures. Analyses of LD1 and LD2 indicate precision associated with laboratory procedures, but not with sample collection, preservation, or storage procedures.
- 3.22 Laboratory Reagent Blank (LRB) – A blank matrix (i.e., DI water) that is treated exactly as a sample including exposure to all glassware, equipment, solvents, and reagents that are used with other samples. The LRB is used to determine if method analytes or other interferences are present in the laboratory environment, the reagents, or the instrument.
- 3.23 Laboratory Control Sample (LCS) – A sample matrix, free from the analytes of interest, spiked with verified known amounts of analytes from a source independent of the calibration standard or a material containing known and verified amounts of analytes. The LCS is generally used to establish intra-laboratory or analyst-specific precision

and bias or to assess the performance of all or a portion of the measurement system. (NELAC)

- 3.24 Limit of Detection (LOD) – The lowest concentration level that can be determined by a single analysis and with a defined level of confidence to be statistically different from a blank. (ACS)
- 3.25 Limit of Quantitation (LOQ) – The minimum levels, concentrations, or quantities of a target variable (target analyte) that can be reported with a specified degree of confidence. The LOQ is set at 3 to 10 times the LOD, depending on the degree of confidence desired.
- 3.26 Linear Dynamic Range (LDR) – The absolute quantity over which the instrument response to an analyte is linear. This specification is also referred to as the Linear Calibration Range (LCR).
- 3.27 Material Safety Data Sheets (MSDS) – Written information provided by vendors concerning a chemical’s toxicity, health hazards, physical properties, fire, and reactivity data including storage, spill, and handling precautions.
- 3.28 May – Denotes permitted action, but not required action. (NELAC)
- 3.29 Method Detection Limit (MDL) – The minimum concentration of an analyte that can be identified, measured, and reported with 98% confidence that the analyte concentration is greater than zero.
- 3.30 Must – Denotes a requirement that must be met. (Random House College Dictionary)
- 3.31 Precision – The degree to which a set of observations or measurements of the same property, obtained under similar conditions, conform to themselves; a data quality indicator. Precision is usually expressed as standard deviation, variance or range, in either absolute or relative terms. (NELAC)
- 3.32 Preservation – Refrigeration, freezing, and/or reagents added at the time of sample collection (or later) to maintain the chemical and or biological integrity of the sample.
- 3.33 Quality Control Sample (QCS) – A sample of analytes of known and certified concentrations. The QCS is obtained from a source external to the laboratory and different from the source of calibration standards. It is used to check laboratory performance with externally prepared test materials.
- 3.34 Run – One sample analysis from start to finish, including printout.
- 3.35 Run Cycle – Typically a day of operation – the entire analytical sequence of runs from the first run to the last run and including the transfer of run cycle data to the disc.
- 3.36 Sample Volume – Amount of volume filtered.
- 3.37 Sensitivity – The capability of a test method or instrument to discriminate between measurement responses representing different levels (concentrations) of a variable of interest.
- 3.38 Shall – Denotes a requirement that is mandatory whenever the criterion for conformance with the specification requires that there be no deviation. (ANSI)

- 3.39 Should – Denotes a guideline or recommendation whenever noncompliance with the specification is permissible. (ANSI)
- 3.40 Standard Reference Material (SRM) – Material which has been certified for specific analytes by a variety of analytical techniques and/or by numerous laboratories using similar analytical techniques. These may consist of pure chemicals, buffers, or compositional standards. The materials are used as an indication of the accuracy of a specific analytical technique.

4. INTERFERENCES

- 4.1 Excessive residue may form a water trapping crust. Sample size should be limited to yield < 200 mg of residue.
- 4.2 Samples from saline waters will not weigh to a constant weight. Therefore they must be rinsed with copious amounts of distilled water.

5. SAFETY

- 5.1 Safety precautions must be taken when handling reagents, samples and equipment in the laboratory.
- 5.2 The muffle furnace becomes extremely hot. Use care when removing crucibles from the furnace. Be sure they have cooled to the touch. Use gloves or tongs if necessary.

6. EQUIPMENT AND SUPPLIES

- 6.1 A four place analytical balance.
- 6.2 Desiccator with drying agents such anhydrous calcium sulfate or silica.
- 6.3 Muffle furnace capable of heating to 550° C.
- 6.4 Freezer, capable of maintaining -20° ± 5° C.

7. REAGENTS AND STANDARDS

- 7.1 Purity of Water – Unless otherwise indicated, references to water shall be understood to mean reagent water conforming to ASTM Specification D 1193, Type I. Freshly prepared water should be used for making the standards intended for calibration. The detection limits of this method will be limited by the purity of the water and reagents used to make the standards.
- 7.2 Blanks – ASTM D1193, Type I water is used for the LRB.
- 7.3 Quality Control Sample (QCS) – For this procedure, the QCS can be any certified dissolved sample which is obtained from an external source. If a certified sample is not available, then use the standard material.

8. SAMPLE COLLECTION, PRESERVATION, AND STORAGE

- 8.1 Water collected for TSS and/or TVS should be filtered through a Whatman GF/F glass fiber filter (nominal pore size 0.7 μm), or equivalent.
- 8.2 Samples should be placed into an aluminum foil pouch and should be frozen at -20°C .
- 8.3 Frozen TSS/TVS samples may be stored longer than 28 days.

9. QUALITY CONTROL

- 9.1 The laboratory is required to operate a formal quality control (QC) program. The minimum requirements of this program consist of an initial demonstration of laboratory capability and the continued analysis of laboratory instrument blanks and calibration standard material, analyzed as samples, as a continuing check on performance. The laboratory is required to maintain performance records that define the quality of data generated.
- 9.2 Initial Demonstration of Capability
 - 9.2.1 The initial demonstration of capability (DOC) – is used to characterize instrument performance (MDLs) and laboratory performance (analysis of QC samples) prior to the analyses conducted by this procedure.
 - 9.2.2 Quality Control Sample (QCS/SRM) – When using this procedure, a quality control sample is required to be analyzed at the beginning and end of the run, to verify data quality and acceptable instrument performance. If the determined concentrations are not within $\pm 10\%$ of the certified values, performance of the determinative step of the method is unacceptable. The source of the problem must be identified and corrected before either proceeding with the initial determination of MDLs or continuing with analyses.
 - 9.2.3 Method Detection Limits (MDLs) – MDLs should be established for TSS and TVS using a low level ambient water sample. To determine the MDL values, analyzed seven replicate aliquots of water. Perform all calculations defined in the procedure (Section xx) and report the concentration values in the appropriate units. Calculate the MDL as follows:
$$\text{MDL} = S \times 3$$

Where, S = Standard Deviation of the
replicate analyses.
 - 9.2.4 MDLs should be determined yearly.

9.3 Assessing Laboratory Performance

- 9.3.1 Laboratory Reagent Blank (LRB) – The laboratory must analyze at least one LRB with each batch of samples. The LRB consists of Nanopure water treated the same as the samples. LRB data are used to assess contamination from the laboratory environment.
- 9.3.2 Quality Control Sample (QCS)/ Standard Reference Material (SRM) – when using this procedure, a quality control sample is required to be analyzed at the beginning of the run and end of the run, to verify data quality and acceptable instrument performance. If the determined concentrations are not within $\pm 3\sigma$ of the certified values, performance of the determinative step of the method is unacceptable. The source of the problem must be identified and corrected before either proceeding with the initial determination of MDLs or continuing with the analyses. The results of these samples shall be used to determine batch acceptance.
- 9.3.3 The QCS will be obtained from a source external to the laboratory and different from the source of calibration standards.

9.4 Data Assessment and Acceptance Criteria for Quality Control Measures

- 9.4.1 If a Total Volatile Solid (TVS) result is more than the Total suspended Solid (TSS) result, an error code 9 is assigned to the sample.
- 9.4.2 If duplicates have been provided for a sample, the results of the two numbers must be compared to each other. If the difference between the two numbers is equal to or more than 50% of the lower number then an error code 14 is assigned.

9.5 Corrective Actions for Out of Control Data

- 9.5.1 Out of control data is not reported. Generally portions of the pad are missing and therefore the measurement is considered useless. An error code is assigned.

10. CALIBRATION AND STANDARDIZATION

- 10.1 Calibration – Daily checks of calibration of balance using a certified weight must be performed before sample analysis may begin. The balance is professionally calibrated annually.

11. PROCEDURE

11.1 Total Suspended Solids

- 11.1.1 On a clean piece of paper lay out filter pads for numbering
- 11.1.2 Use a Sharpie permanent ultra fine or very fine point black marker, sequentially number outside edge of each pad with a unique label.
- 11.1.3 After pads have been labeled, place in a Pyrex dish and dry overnight in a 105° C oven.
- 11.1.4 When ready to weigh, remove pads from oven and place into a desiccator to cool to room temperature.
- 11.1.5 Turn on analytical balance and computer.
- 11.1.6 Check calibration.
- 11.1.7 Click on Balancelink icon and be sure balance has been detected.
- 11.1.8 After pads have come to room temperature, weigh pads individually on balance and enter data into respective spread sheets and store in their labeled boxes for future use.
- 11.1.9 When ready to sample, place pad **numbered side down** onto filtering apparatus.
- 11.1.10 Filter a known volume of sample through the filter pad.
- 11.1.11 Rinse pad very well with deionized water to rinse down filter tower and remove any salts from the pad.
- 11.1.12 Fold pad in half, sample side in and place pad into a labeled foil pouch and place in labeled storage bag and store in -20° C freezer. Place replicate pads side by side in pouch and not on top of each other.
- 11.1.13 When ready to analyze, place opened pouch with sample in 105° C drying oven overnight.
- 11.1.14 Repeat steps 11.1.4 – 11.1.7.
- 11.1.15 Calculate TSS value:

$$\text{mgTSS} / \text{L} = \frac{(\text{W}_{\text{post}(\text{g})} - \text{W}_{\text{pre}(\text{g})}) \times 1000}{\text{V}(\text{L})}$$

11.2 Total Volatile Solids

- 11.2.1 Place pads straight from box into a Pyrex dish and combust at 550° C in a muffle furnace for 1.5 hours.
- 11.2.2 Move pads to a 105° C oven for storage until ready to use.
- 11.2.3 Repeat steps 11.1.4 – 11.1.6.
- 11.2.4 After pads have come to room temperature, weigh pads individually on balance and enter data into respective spread sheets and store into individually labeled Petri dishes for future use.

- 11.2.5 When ready to sample, place pad onto filtering apparatus.
- 11.2.6 Repeat steps 11.1.9 – 11.1.13 to calculate TSS value.
- 11.2.7 Once TSS value has been determined place pad into a numbered porcelain crucible and record crucible number and sample id.
- 11.2.8 Combust samples at 550° C in a muffle furnace for 1.5 hours.
- 11.2.9 Repeat steps 11.1.4 – 11.1.7
- 11.2.10 Calculate TVS:

$$\text{mgTVS} / \text{L} = \frac{(W_{\text{combust(g)}} - W_{\text{post(g)}}) \times 1000}{V(\text{L})}$$

Determination of Dissolved Organic Carbon (NPOC), Total Organic Carbon, and Dissolved Inorganic Carbon in waters of Fresh/Estuarine/Coastal Waters using High Temperature Combustion and Infrared Detection.

1. SCOPE and APPLICATION

- 1.1 High temperature combustion (680°C) is used to determine dissolved organic carbon (DOC), also known as non-purge able organic carbon (NPOC), total organic carbon (TOC), and total (TIC) or dissolved inorganic carbon (DIC), using a non-dispersive infrared detector (NDIR). The method is used to analyze all ranges of salinity.
- 1.2 A Method Detection Limit (MDL) of 0.18 mg/L DOC, and 0.03 mg/L DIC was determined using 3X the standard deviation of 7 replicates.
- 1.3 The quantitation limit for DOC and DIC was set at 0.05 mg/L C.
- 1.4 This procedure should be used by analysts experienced in the theory and application of organic carbon analysis. Three months experience with an experienced analyst, certified in the analysis using the organic carbon analyzer, is required.
- 1.5 This method can be used for all programs that require analysis of dissolved and total organic and inorganic carbon.
- 1.6 This procedure conforms to EPA Method 415.1.

2. SUMMARY

- 2.1 The Shimadzu TOC-5000/5000A uses a high temperature combustion method to analyze aqueous samples for TIC, TOC and non-purge-able organic carbon (NPOC).
- 2.2 NPOC samples are treated with hydrochloric acid and sparged with ultra pure carrier grade air to drive off inorganic carbon. TOC samples are injected directly onto the catalyst bed with no pretreatment. High temperature combustion (680EC) on a catalyst bed of platinum-coated alumina balls breaks down all carbon compounds into carbon dioxide (CO₂). The CO₂ is carried by ultra pure air to a non-dispersive infrared detector (NDIR) where CO₂ is detected.
- 2.3 Samples for inorganic carbon (TIC) are injected directly into a receptacle of 25% phosphoric acid where the carbonates are reduced to CO₂ and detected by the NDIR.

3. DEFINITIONS

- 3.1 Acceptance Criteria – Specified limits placed on characteristics of an item, process, or service defined in a requirement document. (ASQC)
- 3.2 Accuracy – The degree of agreement between an observed value and an accepted reference value. Accuracy includes a combination of random error

- (precision) and systematic error (bias) components which are due to sampling and analytical operations; a data quality indicator. (QAMS)
- 3.3 Aliquot – A discrete, measured, representative portion of a sample taken for analysis. (EPA QAD Glossary)
 - 3.4 Analytical Range - 100 ppb - 4000 ppm using 250 µl syringe and 4 - 100 µl injection volume, using regular sensitivity catalyst.
 - 3.5 Batch – Environmental samples, which are prepared and /or analyzed together with the same process and personnel, using the same lot(s) of reagents. A **preparation batch** is composed of one to 20 environmental samples of the same matrix, meeting the above mentioned criteria and with a maximum time between the start of processing of the first and last sample in the batch to be 24 hours. An **analytical batch** is composed of prepared environmental samples (extracts, digestates, or concentrates) and/or those samples not requiring preparation, which are analyzed together as a group using the same calibration curve or factor. An analytical batch can include samples originating from various environmental matrices and can exceed 20 samples. (NELAC/EPA)
 - 3.6 Blank- A sample that has not been exposed to the analyzed sample stream in order to monitor contamination during sampling, transport, storage or analysis. The blank is subjected to the usual analytical and measurement process to establish a zero baseline or background value and is sometimes used to adjust or correct routine analytical results. (ASQC)
 - 3.7 Calibrate- To determine, by measurement or comparison with a standard, the correct value of each scale reading on a meter or other device, or the correct value for each setting of a control knob. The levels of the applied calibration standard should bracket the range of planned or expected sample measurements. (NELAC)
 - 3.8 Calibration – The set of operations which establish, under specified conditions, the relationship between values indicated by a measuring device. The levels of the applied calibration standard should bracket the range of planned or expected sample measurements. (NELAC)
 - 3.9 Calibration Curve – The graphical relationship between known values, such as concentrations, or a series of calibration standards and their analytical response. (NELAC)
 - 3.10 Calibration Method – A defined technical procedure for performing a calibration. (NELAC)
 - 3.11 Calibration Standard – A substance or reference material used to calibrate an instrument. (QAMS)
 - 3.11.1 Initial Calibration Standard (STD) – A series of standard solutions used to initially establish instrument calibration responses and develop calibration curves for individual target analytes.
 - 3.11.2 Initial Calibration Verification (ICV) – An individual standard, analyzed initially, prior to any sample analysis, which verifies acceptability of the calibration curve or previously established calibration curve.
 - 3.11.3 Continuing Calibration Verification (CCV) – An individual standard which is analyzed after every 10-15 field sample analysis.

- 3.12 Certified Reference Material – A reference material one or more of whose property values are certified by a technically valid procedure, accompanied by or traceable to a certificate or other documentation which is issued by a certifying body. (ISO 17025)
- 3.13 Combustion tube – Quartz tube filled with platinum catalyst, heated to 680° C, into which the sample aliquot is injected.
- 3.14 Conditioning Blank – DI water run before the calibration curve to decrease the instrument blank and stabilize the column conditions.
- 3.15 Corrective Action – Action taken to eliminate the causes of an existing nonconformity, defect or other undesirable situation in order to prevent recurrence. (ISO 8402)
- 3.16 Deficiency – An unauthorized deviation from acceptable procedures or practices. (ASQC)
- 3.17 Demonstration of Capability – A procedure to establish the ability of the analyst to generate acceptable accuracy. (NELAC)
- 3.18 Detection Limit – The lowest concentration or amount of the target analyte that can be determined to be different from zero by a single measurement at a stated degree of confidence.
- 3.19 Duplicate Analysis – The analyses of measurements of the variable of interest performed identically on two sub samples (aliquots) of the same sample. The results from duplicate analyses are used to evaluate analytical or measurement precision but not the precision of sampling, preservation or storage internal to the laboratory. (EPA-QAD)
- 3.20 External Standard (ES) – A pure analyte (potassium hydrogen phthalate (KHP)) that is measured in an experiment separate from the experiment used to measure the analyte(s) in the sample. The signal observed for a known quantity of the pure external standard is used to calibrate the instrument response for the corresponding analyte(s). The instrument response is used to calculate the concentrations of the analyte(s) in the unknown sample.
- 3.21 Field Duplicates (FD1 and FD2) – Two separate samples collected at the same time and place under identical circumstances and treated exactly the same throughout field and laboratory procedures. Analyses of FD1 and FD2 provide a measure of the precision associated with sample collection, preservation and storage, as well as with laboratory procedures.
- 3.22 Field Reagent Blank (FRB) – A aliquot of reagent water or other blank matrix that is placed in a sample container in the laboratory and treated as a sample in all respects, including shipment to the sampling site, exposure to the sampling site conditions, storage, preservation, and all analytical procedures. The purpose of the FRB is to determine if method analytes or other interferences are present in the field environment.
- 3.23 Furnace – Heats the combustion tube to the operating temperature of 680° C.
- 3.24 Holding time – The maximum time that samples may be held prior to analysis and still be considered valid. (40 CFR Part 136) The time

elapsed from the time of sampling to the time of extraction or analysis, as appropriate.

- 3.25 Injection – The sample aliquot that is drawn into the syringe and injected into the combustion tube.
- 3.26 Instrument Detection Limit (IDL) – The minimum quantity of analyte of the concentration equivalent which gives an analyte signal equal to three times the standard deviation of the background signal at the selected wavelength, mass, retention time absorbance line, etc.
- 3.27 Laboratory Duplicates (LD1 and LD2) – Two aliquots of the same sample taken in the laboratory and analyzed separately with identical procedures. Analyses of LD1 and LD2 indicate precision associated with laboratory procedures, but not with sample collection, preservation, or storage procedures.
- 3.28 Laboratory Reagent Blank (LRB) – A matrix blank (i.e., DI water) that is treated exactly as a sample including exposure to all glassware, equipment, solvents, and reagents that are used with other samples. The LRB is used to determine if method analytes or other interferences are present in the laboratory environment, the reagents, or the instrument.
- 3.29 Laboratory Control Sample (LCS) – A sample matrix, free from the analytes of interest, spiked with verified known amounts of analytes from a source independent of the calibration standard or a material containing known and verified amounts of analytes. The LCS is generally used to establish intra-laboratory or analyst-specific precision and bias or to assess the performance of all or a portion of the measurement system. (NELAC)
- 3.30 Limit of Detection (LOD) – The lowest concentration level that can be determined by a single analysis and with a defined level of confidence to be statistically different from a blank. (ACS)
- 3.31 Limit of Quantitation (LOQ) – The minimum levels, concentrations, or quantities of a target variable (target analyte) that can be reported with a specified degree of confidence. The LOQ is set at 3 to 10 times the LOD, depending on the degree of confidence desired.
- 3.32 Linear Dynamic Range (LDR) – The absolute quantity over which the instrument response to an analyte is linear. This specification is also referred to as the Linear Calibration Range (LCR).
- 3.33 Material Safety Data Sheets (MSDS) – Written information provided by vendors concerning a chemical's toxicity, health hazards, physical properties, fire, and reactivity data including storage, spill, and handling precautions.
- 3.34 May – Denotes permitted action, but not required action. (NELAC)
- 3.35 Method Detection Limit (MDL) – The minimum concentration of an analyte that can be identified, measured, and reported with 98% confidence that the analyte concentration is greater than zero.
- 3.36 Must – Denotes a requirement that must be met. (Random House College Dictionary)

- 3.37 Non-Dispersive Infrared Detector (NDIR) – The detector found in the Shimadzu 5000/5000A TOC analyzer. Carbon dioxide is detected.
- 3.38 Precision – The degree to which a set of observations or measurements of the same property, obtained under similar conditions, conform to themselves; a data quality indicator. Precision is usually expressed as standard deviation, variance or range, in either absolute or relative terms. (NELAC)
- 3.39 Preservation – Refrigeration, freezing, and/or reagents added at the time of sample collection (or later) to maintain the chemical and or biological integrity of the sample.
- 3.40 Quality Control Sample (QCS) – A sample of analytes of known and certified concentrations. The QCS is obtained from a source external to the laboratory and different from the source of calibration standards. It is used to check laboratory performance with externally prepared test materials.
- 3.41 Run – One sample analysis from start to finish, including printout.
- 3.42 Run Cycle – Typically a day of operation – the entire analytical sequence of runs from the first run to the last run and including the transfer of run cycle data to the disc.
- 3.43 Sample Volume – Amount of sample injected into the combustion tube.
- 3.44 Sensitivity – The capability of a test method or instrument to discriminate between measurement responses representing different levels (concentrations) of a variable of interest.
- 3.45 Shall – Denotes a requirement that is mandatory whenever the criterion for conformance with the specification requires that there be no deviation. (ANSI)
- 3.46 Should – Denotes a guideline or recommendation whenever noncompliance with the specification is permissible. (ANSI)
- 3.47 Sparge Time – The time required to aerate an acidified sample with ultra pure air to remove inorganic carbon to determine the concentration of organic carbon.
- 3.48 Standard Reference Material (SRM) – Material which has been certified for specific analytes by a variety of analytical techniques and/or by numerous laboratories using similar analytical techniques. These may consist of pure chemicals, buffers, or compositional standards. The materials are used as an indication of the accuracy of a specific analytical technique.

4. INTERFERENCES

- 4.1 Carbonates and bicarbonates may interfere with the determination of organic carbon by increasing the concentration of CO₂ detected. These are removed by adding enough 2N HCl to the sample to bring the pH to 2 or below, then sparging with ultra-pure air for a predetermined time.

5. SAFETY

- 5.1 Safety precautions must be taken when handling reagents, samples and equipment in the laboratory. Protective clothing including lab coats, safety glasses and enclosed shoes should be worn. In certain situations, it will be necessary to also use gloves and/or a face shield. If solutions come in contact with eyes, flush with water continuously for 15 minutes. If solutions come in contact with skin, wash thoroughly with soap and water. Contact Solomons Rescue Squad (911) if emergency treatment is needed and also inform the CBL Business Manager of the incident. Contact the CBL Business Manager if additional treatment is required.
- 5.2 The toxicity or carcinogenicity of each reagent used in this procedure may not have been fully established. Each chemical should be regarded as a potential health hazard and exposure should be as low as reasonably achievable. Cautions are included for known hazardous materials and procedures.
- 5.3 Do not wear jewelry when troubleshooting electrical components. Even low voltage points are dangerous and can injure if allowed to short circuit.
- 5.4 The following hazard classifications are listed for the chemicals used in this procedure. Detailed information is provided on Material Safety Data Sheets (MSDS).

Chemical	Health	Flammability	Reactivity	Contact	Storage
Potassium Hydrogen Phthalate	0	1	0	1	Green
Sodium Carbonate, Anhydrous	1	0	1	2	Green
Sodium Bicarbonate	1	1	1	1	Green
Phosphoric Acid	3	0	2	4	White
Hydrochloric Acid	3	0	2	4	White
Sodium Hydroxide	3	0	2	4	White Stripe
Platinum Catalyst on Alumina Beads	1	0	1	1	Green
Soda Lime	1	0	1	3	White

On a scale of 0 to 4 the substance is rated on four hazard categories: health, flammability, reactivity, and contact. (0 is non-hazardous and 4 is extremely hazardous)

STORAGE

Red – Flammability Hazard: Store in a flammable liquid storage area.

Blue – Health Hazard: Store in a secure poison area.

Yellow – Reactivity Hazard: Keep separate from flammable and combustible materials.

White – Contact Hazard: Store in a corrosion-proof area.

Green – Use general chemical storage (On older labels, this category was orange).

Striped – Incompatible materials of the same color class have striped labels. These products should not be stored adjacent to substances with the same color label. Proper storage must be individually determined.

6. EQUIPMENT AND SUPPLIES

6.1 A Total Organic Carbon Analyzer capable of maintaining a combustion temperature of 680° C and analyzing for organic and inorganic carbon. The Shimadzu TOC5000 and the Shimadzu TOC5000A are used in this laboratory.

6.2 Freezer, capable of maintaining $-20 \pm 5^{\circ}$ C.

6.3 Lab ware – All reusable lab ware (glass, Teflon, plastic, etc) should be sufficiently clean for the task objectives. This laboratory soaks all lab ware related to this method in a 10% HCl (v/v) acid bath overnight.

7. REAGENTS AND STANDARDS

7.1 Purity of Water – Unless otherwise indicated, references to water shall be understood to mean reagent water conforming to ASTM Specification D 1193, Type I. Freshly prepared water should be used for making the standards intended for calibration. The detection limits of this method will be limited by the purity of the water and reagents used to make the standards.

7.2 Purity of Reagents – Reagent grade chemicals shall be used in all tests. Unless otherwise indicated, it is intended that all reagents shall conform to specifications of the Committee on Analytical Reagents of the American Chemical Society, where such specifications are available. Other grades may be used, provided it is first ascertained that the reagent is of sufficiently high purity to permit its use without compromising the accuracy of the determination.

7.3 Potassium Hydrogen Phthalate (KHP) $C_6H_4(COOK)(COOH)$ – primary standard for organic carbon.

7.4 Sodium Hydrogen Carbonate ($NaHCO_3$) and Sodium Carbonate (Na_2CO_3) – primary standard for inorganic carbon.

7.5 Hydrochloric Acid, 2 N –
 Hydrochloric acid (HCl), concentrated, 172 ml
 Deionized water, q.s. 1000 ml

In a 1000 ml volumetric flask, add 172 ml of concentrated hydrochloric acid to ~600 ml of deionized water. Dilute to 1000 ml with deionized water.

- 7.6 Organic Carbon Stock Standard: Potassium Hydrogen Phthalate (KHP) Standard, 1000 mg/l
 Potassium hydrogen phthalate ($\text{HOCOC}_6\text{H}_4\text{COOK}$),
 Dried at 45° C 2.125 g
 Deionized water 1000 ml

In a 1000 ml volumetric flask, dissolve 2.125 g of potassium hydrogen phthalate in ~800 ml of deionized water. Dilute to 1000 ml with deionized water. Make fresh every 4 - 6 months. Store at 4° C.

- 7.7 Inorganic Carbon Stock Standard: Sodium Hydrogen Carbonate/ Sodium Carbonate ($\text{NaHCO}_3/\text{Na}_2\text{CO}_3$) Standard, 1000 mg/l
 Sodium Hydrogen Carbonate (NaHCO_3) 1.75 g
 Sodium Carbonate, Anhydrous (Na_2CO_3) 2.205 g
 Deionized H_2O 500 ml

In a 500 ml volumetric flask, dissolve 1.75 g NaHCO_3 and 2.205 g Na_2CO_3 in ~300 ml deionized H_2O . Dilute to 500 ml with deionized H_2O . Make fresh every 4 months. Store at 4° C.

- 7.8 Blanks – Two blanks are used in calculations for this analysis.
- 7.8.1 ASTM D1193, Type I water is used for the Laboratory Reagent Blank. The LRB is comprised of the instrument blank plus the organic content found within the TYPE I water. The area of the LRB is subtracted from the area of the standards.
 - 7.8.2 For ambient water samples, the LRB cannot be used, because the samples have no added Type I water. Because the instrument has an internal blank that is not constant, the instrument blank is determined to be the **absolute value** of the y intercept. This value is subtracted from the area of the samples.
 - 7.8.3 If the ambient water sample is diluted with TYPE I water, then the LRB must be used in the calculation.
 - 7.8.4 This does not apply to TIC samples. The instrument blank for inorganic carbon is insignificant, so no blank is subtracted from the samples.
- 7.9 Quality Control Sample (QCS) – For this procedure, the QCS can be any certified dissolved sample which is obtained from an external source. If a certified sample is not available, then use the standard material (KHP).

8 SAMPLE COLLECTION, PRESERVATION, AND STORAGE

- 8.1 Water collected for DOC and/or DIC should be filtered through a Whatman GF/F glass fiber filter (nominal pore size 0.7 μm), or equivalent.

- 8.2 Water collected for DOC should be frozen at -20° C, or acidified with 2N HCl to a pH of ≤ 2 . Water collected for DIC should not be acidified. The sample container should be either borosilicate glass or Teflon. Plastic containers may be used if well cleaned and aged. Freshwater samples should be frozen in Teflon or plastic to prevent breakage.
- 8.3 Frozen DOC and/or DIC samples may be stored longer than 28 days. It has been shown that frozen QCS samples up to a year old still fall well within the control limits.
- 8.4 DOC samples acidified with 2N HCL should be frozen, as above, or refrigerated at 4° C for no longer than 28 days.
- 8.5 DIC samples stored at 4° C should be analyzed within 28 days.

9 QUALITY CONTROL

9.1 The laboratory is required to operate a formal quality control (QC) program. The minimum requirements of this program consist of an initial demonstration of laboratory capability and the continued analysis of laboratory instrument blanks and calibration standard material, analyzed as samples, as a continuing check on performance. The laboratory is required to maintain performance records that define the quality of data generated.

9.2 Initial Demonstration of Capability

- 9.2.1 The initial demonstration of capability (DOC) – is used to characterize instrument performance (MDLs) and laboratory performance (analysis of QC samples) prior to the analyses conducted by this procedure.
- 9.2.2 Quality Control Sample (QCS/SRM) – When using this procedure, a quality control sample is required to be analyzed at the beginning and end of the run, to verify data quality and acceptable instrument performance. If the determined concentrations are not within $\pm 10\%$ of the certified values, performance of the determinative step of the method is unacceptable. The source of the problem must be identified and corrected before either proceeding with the initial determination of MDLs or continuing with analyses.
- 9.2.3 Method Detection Limits (MDLs) – MDLs should be established for DOC and DIC using a low level ambient water sample. To determine the MDL values, analyzed seven replicate aliquots of water. Perform all calculations defined in the procedure (Section 10) and report the concentration values in the appropriate units. Calculate the MDL as follows:

$$\text{MDL} = S \times 3$$

Where, S = Standard Deviation of the replicate analyses.

9.2.4 MDLs should be determined yearly.

9.3 Assessing Laboratory Performance

- 9.3.1 Laboratory Reagent Blank (LRB) – The laboratory must analyze at least one LRB with each batch of samples. The LRB consists of Nanopure water treated the same as the samples. LRB data are used to assess contamination from the laboratory environment.
- 9.3.2 Quality Control Sample (QCS)/ Standard Reference Material (SRM) – when using this procedure, a quality control sample is required to be analyzed at the beginning of the run and end of the run, to verify data quality and acceptable instrument performance. If the determined concentrations are not within $\pm 3\sigma$ of the certified values, performance of the determinative step of the method is unacceptable. The source of the problem must be identified and corrected before either proceeding with the initial determination of MDLs or continuing with the analyses. The results of these samples shall be used to determine batch acceptance.
- 9.3.3 The QCS will be obtained from a source external to the laboratory and different from the source of calibration standards.
- 9.3.4 Control Charts – The SRM data is graphed, and the slope, y-intercept, and r squared data are compiled and tracked.
- 9.3.5 Continuing Calibration Verification (CCV) – Following every 12-15 samples, one or two CCVs are analyzed to assess instrument performance. The CCVs are made from the same material as calibration standards (KHP), and are to be within $TV \pm 3\sigma$. Failure to meet the criteria constitutes correcting the problem and reanalyzing the samples. If not enough sample exists, the data must be qualified if reported.

9.4 Assessing Analyte Recovery

- 9.4.1 Matrix spikes are performed on a 20% QA/QC basis.
- 9.4.2 0.5 ml of the highest KHP standard in the curve is added to 5.0 ml of sample for a total volume of 5.5 ml.
- 9.4.3 0.5 ml standard $0.5/5.5 = 0.09$
- 9.4.4 0.09 X STD conc.
- 9.4.5 5.0 ml sample $5.0/5.5 = 0.91$
- 9.4.6 (original sample conc. X 0.91) + (0.09 x std conc.) = (expected conc.) mg/L

9.5 Data Assessment and Acceptance Criteria for Quality Control Measures

9.5.1 The Acceptance Criteria for DOC is 0.9990. If the r^2 is less than acceptable, all blanks and standards analyzed during the run may be averaged into the curve.

9.6 Corrective Actions for Out of Control Data

9.6.1 If the acceptance criteria are still not met, the samples are to be rerun.

10 CALIBRATION AND STANDARDIZATION

10.1 Calibration – Daily calibration must be performed before sample analysis may begin. Four point calibration is used with the Shimadzu TOC 5000/5000A.

10.1.1 Type I water is used as the “zero point” in the calibration. Because even Type I water contains some organic carbon, the area count response is subtracted from the standards as the water blank, forcing the curve through zero. The standards are calculated by the following equation:

$$\text{mg TOC/L} = (A_{\text{STD}} - A_{\text{H}_2\text{OBLK}}) / m$$

Where: A_{STD} = Area of the standard
 $A_{\text{H}_2\text{OBLK}}$ = Area of water blank
 m = slope of the regression line

TOC sample concentration is calculated using the following equation:

$$\text{mg TOC/L} = (A_s - |b|) / m$$

Where: A_s = area of the sample,
 b = y-intercept, and
 m = slope of the regression line

11 PROCEDURE

11.1 How to run the Shimadzu 5000

11.1.1 Turn on the gas.

11.1.2 Turn on instrument. The power switch is located on the right side of the instrument.

11.1.3 Instrument checks when turning on: Check level of liquid in the humidifier, located in the lower right corner inside. The level should be between the two lines. If low—add

DHOH. Unscrew cap on the side and squirt in up to upper line.

- 11.1.4 Turn on ASI. Press F5 to initialize the ASI. Make sure the turntable is in place to avoid error messages. If the ASI is turned on after opening the MAIN MENU, the instrument will automatically initialize the ASI. Samples may be loaded onto the carousel while the TOC-5000 is warming up. Just make sure the turntable is in place before turning on the ASI.
- 11.1.5 Use the F keys to navigate. Go to NEXT (F1) which opens the MAIN MENU. Press 3 and Enter for General Conditions.
- 11.1.6 Using arrow keys, scroll down to TOC furnace. Press 1 and Enter to turn on furnace. Return to MAIN MENU (F2). Make sure liquid in the TIC chamber —plastic reservoir inside in upper center— is bubbling. If not, there is a leak.
- 11.1.7 Press 6 and Enter to get to MONITOR SCREEN. This screen allows you to monitor instrument conditions. It takes 20-30 minutes to come to temperature.
- 11.1.8 Loading Samples: Decide on standard curve.
 - 11.1.8.1 NPOC conditioning curve: Place a std vial of DHOH in position S1. (This vial may also be used as the zero std of the calibration curve.) Load at least 3 sample vials of DHOH in positions 1-3. 100 µl injection, range 1, 9 max 10 injections, 3 minute sparge.
 - 11.1.8.2 NPOC: I use 2 curves: Low — 0-10 ppm - --- DHOH, 2.0, 5.0, 10.0 as calibration standards, and adding 0.5, 1.0, and 7.5 as well for stds as samples. 60 µL injection, range 1, 6 min sparge.
High----- 0-20 ppm ----- DHOH, 5.0, 10.0, 20.0 as calibrating stds and adding 1.0, 2.0, & 15.0 as stds as samples. 30 µL injection, range 1, 6 min sparge. The instrument allows up to a 4 point curve.
 - 11.1.8.3 TIC: This analysis is not performed on a regular basis; therefore the samples are analyzed using a curve of 0-30 ppm Na₂CO₃/NaHCO₃ and an injection volume of 25 µl in range 1. If the samples fall within the low end of the curve, the curve range and injection volume are adjusted accordingly. If the samples fall off scale, they are diluted.

- 11.1.9 Use the large sample vials for the curve stds. Examples of sample protocol can be found in the data sheet notebook.
- 11.1.10 I always load several DHOH samples (at least 3) as conditioning samples.
- 11.1.11 Fill std vials ~ 1/3 to 1/2 full.
- 11.1.12 Fill sample vials to within 3/4 - 1" of the top. Acidify the NPOC samples by adding 100 µl of 2N HCl. The instrument can be set up to automatically add acid to the standard cups. Make sure a standard cup filled with 2N HCl is in position S8. DO NOT acidify TIC samples.
- 11.1.13 Data sheets are found in the LOTUS TOC5000 folder, labeled TOC datasheet, high, low std. Print as many as needed. (Low std set to print 5; high std prints 2, and plain datasheet prints 1.) Examples are found before section 12.
- 11.1.14 When the turntable is loaded, place in the ASI. Line up pins to align properly. Put top on lining up pins carefully. Sample needles will Z if the top is not properly aligned.
- 11.1.15 Go to the MAIN MENU — Press 9 and Enter for the AUTOSAMPLER.
- 11.1.16 Determine analysis type: Press 1 for TC, 2 for IC, 3 for TOC, 4 for NPOC on each to be used, one line per curve. The instrument can store up to 18 curves.
- 11.1.17 Create 2 std curves for NPOC. Using the number keys, toggle the sample type to NPOC. Enter sample positions under IS and FS, and curve # under C1. Curve #1 is used as the conditioning curve. At least vials 1 -3 of DHOH and the std DHOH (S1). (9 max 10 injections, 100 µl, range = 1, 3 minute sparge, and curve not through zero.) Curves 2-18 are used as sample curves. See 11.1.19.
- 11.1.18 If analyzing TIC, create 1 std curve for TIC. Using the number keys, toggle the sample type to TIC.
- 11.1.19 Enter curve # under C1 and ENTER. This opens the screen to input curve data. Use arrow keys to navigate. Enter std conc. & position (S1, S2, etc.)
- 11.1.19.1 NPOC: Range = 1, inj vol 60 µL for low curve and 30 µL for high curve. 3 max 5 injections, 200 SD, 2.0% CV, 6 minute sparge, acid addition on, and curve forced through zero.
- 11.1.19.2 TIC: Range = 1, inj. vol 25 µl for 0-30 ppm curve. 3 max 5 injections, 200 SD, 2.0% CV.
- 11.1.20 Return to SAMPLE CONDITIONS. Make sure sample conditions match curve conditions. Ex: # of inj, sparge time, etc.
- 11.1.21 When all is set, press F1 (NEXT)
- 11.1.22 Decide whether to leave instrument in 1 (Finish), 2 (Running), or 3 (No Change)

- 11.1.23 Press F1 (NEXT)
- 11.1.24 Press Start
- 11.1.25 Check paper supply
- 11.1.26 Make sure the Rinse Reservoir is full.
- 11.1.27 Make sure the waste bottle has room.

11.2 Shutdown procedure for the TOC5000.

- 11.2.1 Make sure the Autosampler needles are in the home position.
- 11.2.2 Open MAIN MENU (F2).
- 11.2.3 Enter 7 for STANBY OPTIONS
- 11.2.4 Press STANBY (F1) to shutdown. This turns the furnace off and closes the main pressure valve.
- 11.2.5 Wait 30 minutes before turning off power.

11.3 How to run the Shimadzu 5000A

- 11.3.1 Turn on gas.
- 11.3.2 Turn on instrument.
- 11.3.3 Turn on laptop and open TOCControl. There is no password, so just hit ENTER. Turn on TOC5000A. The power switch is located on the left hand side behind the Autosampler.
- 11.3.4 Open communication to instrument by clicking on the connect button on top button bar. (Looks like two plugs connecting). The computer will go through a series of checks before connecting.
- 11.3.5 Instrument checks when turning on: Check level of liquid in the humidifier, located in the lower right corner inside. The level should be between the two lines. If low—add DHOH. Unscrew cap on the side and squirt in up to upper line. Make sure liquid in the TIC chamber —plastic reservoir in upper center— is bubbling. If not, there is a leak.
- 11.3.6 The furnace automatically turns on when connected. It takes 20-30 minutes to come to temperature.
- 11.3.7 To view instrument conditions, click on View /Background Monitor. When all conditions are OK, the system is ready to run.
- 11.3.8 Loading Samples: Decide on standard curve. I use 2 curves:
 Low — 0-10 ppm ---- DHOH, 2.0, 5.0, 10.0 as calibration standards, and adding 0.5, 1.0, and 7.5 as well for stds as samples. 60 µL injection. High-----
 0-20 ppm ----- DHOH, 5.0, 10.0, 20.0 as calibrating STDs and adding 1.0, 2.0, & 15.0 as STDs as samples. 30 µL injection. The instrument allows up to a 4 point curve.

- 11.3.9 Use the large sample vials for the curve stds. Examples of sample protocol can be found in the data sheet notebook.
- 11.3.10 I always load several DHOH samples (at least 3) as conditioning samples
- 11.3.11 Fill std vials ~ 1/3 to 1/2 full.
- 11.3.12 Fill sample vials to within 3/4 - 1" of the top.
- 11.3.13 Data sheets are found in the LOTUS TOC5000 folder on the desktop, labeled TOC datasheet, high, low std. Print as many as needed. (Low STD set to print 5; high STD prints 2, and plain datasheet prints 1.)
- 11.3.14 Acidify the samples by adding 100 µl of 2N HCl. The standard curve files are set up to automatically add acid to the standard cups. Make sure a standard cup filled with 2 N HCl is in position S8.
- 11.3.15 When the turntable is loaded, place in the ASI. Line up pins to align properly. Put top on lining up arrows carefully. Sample needles will Z if the top is not properly aligned.
- 11.3.16 Close the Background Monitor and a blank sample table will be opened.
- 11.3.17 Enter sample table by clicking on Edit/Insert Std. Click on CONDBLK.CAL. Then click on Edit/Autogenerate. In the method name slot, type CONDBLK.MET. Using the TAB, toggle through to fill in the blanks. This is an NPOC file. I usually put conditioning DHOH vials in positions 1-3. The standard curve is next. Several curves are already stored. Click on Edit/ insert STD again to choose the proper curve. LOSTD10 is a 0-10 ppm curve with DHOH, 2.0, 5.0, & 10 in positions S1, 2, 3, 4. HISTD20 is a 0-20 ppm curve with DHOH, 5.0, 10.0, 20.0 in positions S1, 2, 3, 4.
- 11.3.18 Click on Edit/ Insert Sample next. Most likely this is a new file, so click on NEW. You will then be prompted enter the conditions of the samples to be run. Enter a file name (up to 8 characters), and TAB to the next slot. Enter the sample information (ex. DNR Potomac 3/30/08). TAB again to enter sample name (ex. Potomac), TAB to next and hit backspace to clear. This leaves the SAMPLE ID column blank so ID's can be entered when the table is completed. TAB again, and using the down arrow, choose the NPOC option. Click on NPOC tab at top to enter standard information. Click on Browse to choose standard curve. (LOSTD10 or HISTD20). Injection volumes and other stored info will be displayed. Click OK on each of the screens that pop up. You will be prompted to save the method file. (Up to 8 characters. Ex: POT0330). At this point, one line is added to the sample table. The sample vial position is blank. Type in the vial position (usually 4) from the bench sheet and hit enter. Move the cursor to the next line

down, first column and click. To enter the rest of the sample table, click on Edit/ Autogenerate. Enter the file name.met and TAB to enter vial positions (starting with 5.) If you have more than one group of samples, you may use autogenerate several times to enter each group. EX: Potomac uses vial positions 5-46, Chincoteague 47-60, and MDE Loch Raven 61-78. Each time you enter autogenerate, be sure to change the name of the group. The method file remains the same.

- 11.3.19 When the sample table is entered, go back and enter the sample ID's. Save the table using the same name as the method file.
- 11.3.20 Click Start.
- 11.3.21 Choose whether to keep instrument on at end of run or to finish. Click OK. Click OK again to acknowledge that the acid container is in position S8.
- 11.3.22 Do not run instrument with computer hooked up to the network. It increases the chances of the system locking up.
- 11.3.23 Make sure the Rinse Reservoir is full.
- 11.3.24 Make sure the waste bottle has room.
- 11.3.25 When the run is finished, reconnect to the network and save the file to P:drive/Kaumeyer, so it can be accessed by the desktop.

11.4 Shutdown Procedure for the TOC5000A

- 11.4.1 Make sure the Autosampler needles are in the home position.
- 11.4.2 Make sure the software is in Standby. (Should say Standby in lower left corner of screen.)
- 11.4.3 Click on connection button (next to ? button, 2nd from right)
- 11.4.4 Click OK to disconnect instrument.
- 11.4.5 Close program - shutdown computer.
- 11.4.6 Turn off instrument (on left behind ASI).
- 11.4.7 If instrument is not in standby:
- 11.4.8 Click on Halt to stop program
- 11.4.9 .The ASI needles should rise and go to home position. (They don't always)
- 11.4.10 Click on Measure, then Standby.
- 11.4.11 Click on OK in screen to shutdown. Wait at least 30 minutes for the furnace to cool.
- 11.4.12 Click Close to remove that screen.
- 11.4.13 After 30 minutes, follow shutdown procedure above.

SHIMADZU DATA SHEET

CRUISE :

TODAY'S DATE:

INSTRUMENT

USED:

MANUAL/PC CONTROL

ANALYST: NLK OTHER:

SPIKE CONC.:

INJECTION

FILE

VOLUME:

NAME:

VIAL/STD AREA

VIAL/ST

VIAL/ST

cond std

S1

D

AREA

D

AREA

S2

S4

S7

ACID

S3

S5

S8

S6

VIAL/ID AREA VIA

ID

AREA

VIAL

ID

AREA

1 COND

27

53

2 COND

28

54

3 COND

29

55

4 DHOH

30

56

5 DHOH

31

57

6

32

58

7

33

59

8

34

60

9

35

61

10

36

62

11

37

63

12

38

64

13

39

65

14

40

66

15

41

67

16

42

68

17

43

DHOH

69

18

44

70

19

45

71

20

46

72

21

47

73

22

48

74

23

49

75

24

50

76

25

51

77

26

52

78

SHIMADZU DATA SHEET

CRUISE :

TODAY'S DATE:

INSTRUMENT USED:

MANUAL/PC CONTROL

ANALYST: NLK OTHER:

INJECTION VOLUME: 60

FILE

SPIKE CONC.: 10 mg/L KHP

uL

NAME:

VIAL/STD

AREA

VIAL/STD

AREA

VIAL/STD

AREA

cond std	S1 DHOH	S4 10.0 KHP	S7
	S2 2.0 KHP	S5	S8 ACID
	S3 5.0 KHP	S6	

VIAL/ID	AREA	VIAL	ID	AREA	VIAL	ID	AREA
1 COND		27			53		
2 COND		28			54		
3 COND		29			55		
4 DHOH		30			56		
5 DHOH		31			57		
6 0.5 KHP		32			58		
7 1.0 KHP		33			59		
8 2.0 KHP		34			60		
9 5.0 KHP		35			61		
10 7.5 KHP		36			62		
11 10.0 KHP		37			63		
12 DHOH		38			64		
13 DHOH		39			65		
14		40			66		
15		41			67		
16		42			68		
17		43	DHOH		69		
18		44			70		
19		45			71		
20		46			72		
21		47			73		
22		48			74		
23		49			75		
24		50			76		
25		51			77		
26		52			78		

SHIMADZU DATA
SHEET

CRUISE :

TODAY'S DATE:

INSTRUMENT USED:

MANUAL/PC CONTROL

ANALYST: NLK OTHER:

INJECTION VOLUME: 30

FILE
NAME:

SPIKE CONC.: 20 mg/L KHP

uL

VIAL/STD

AREA

VIAL/STD

AREA

VIAL/STD

AREA

cond std

S1 DHOH

S4 20.0 KHP

S7

S2 5.0 KHP

S5

S8

ACID

S3 10.0 KHP

S6

VIAL/ID	AREA	VIAL	ID	AREA	VIAL	ID	AREA
1 COND		27			53		
2 COND		28			54		
3 COND		29			55		
4 DHOH		30			56		
5 DHOH		31			57		
6 1.0 KHP		32			58		
7 2.0 KHP		33			59		
8 5.0 KHP		34			60		
9 10.0 KHP		35			61		
10 15.0 KHP		36			62		
11 20.0 KHP		37			63		
12 DHOH		38			64		
13 DHOH		39			65		
14		40			66		
15		41			67		
16		42			68		
17		43	DHOH		69		
18		44			70		
19		45			71		
20		46			72		
21		47			73		
22		48			74		
23		49			75		
24		50			76		
25		51			77		
26		52			78		

12. Maintenance Schedule for the TOC5000/5000A

12.1 Daily:

- 12.1.1 Check liquid level in humidifier. Add DHOH to top line if level is too low. Keep level between top and bottom scored lines on vessel.
- 12.1.2 Check paper supply if using either instrument in Stand Alone Mode.
- 12.1.3 Make sure that the liquid in the IC pot is bubbling once the furnace is on. Lack of bubbling means a leak is present.
- 12.1.4 Main gas pressure setting @ 4.5 kg/cm².
- 12.1.5 Carrier gas setting @ 150 cc.
- 12.1.6 Sparge gas setting @ ~30-60 cc when in use.
- 12.1.7 Check the level of the rinse container.
- 12.1.8 Carrier gas pressure. Use Ultra Zero grade Air from Airgas or comparable grade. UZ Air is a synthetic blend containing 20-22% oxygen, < 1 ppm CO + CO₂ combined, < 2% H₂O, < 0.1% THC.

12.2 Monthly, approximately or after 15-18 analytical batches:

12.2.1 Consumables parts list:

- 12.2.1.1 PN 017-42801-01 TC catalyst, regular sensitivity
- 12.2.1.2 PN 036-11209-84 Black o-rings, injection port; 5/pk
- 12.2.1.3 PN 036-11408-84 Teflon o-rings (white), 5/pk
- 12.2.1.4 PN 630-01565-00 injection port needle
- 12.2.1.5 PN 638-41323-00 TC combustion tube
- 12.2.1.6 PN 220-91101-00 syringe plunger w/tip
- 12.2.1.7 PN 630-00105-01 platinum screens, 2/pk
- 12.2.1.8 PN 630-02674-01 mist trap filter ball
- 12.2.1.9 PN 035-62994-03 Teflon ferrules, TOC5000 only
- 12.2.1.10 PN 630-00707-00 cooling coil, TOC5000 only
- 12.2.1.11 PN 200-91532-02 printer paper
- 12.2.1.12 PN 638-41314-00 cooling coil, TOC5000A only
- 12.2.1.13 PN 638-41284-00 ASI sampling needles
- 12.2.1.14 PN 630-01566-00 Teflon coated o-ring
- 12.2.1.15 PN 630-00635-01 KHP, primary std
- 12.2.1.16 PN 630-00962-01 Na₂CO₃, primary std
- 12.2.1.17 PN 630-00963-01 NaHCO₃, primary std

- 12.2.1.18 JT Baker PN 1820-01 Cupric Oxide Wire, Baker Analyzed, A.C.S. Reagent grade or equivalent.
- 12.2.2 Make sure oven is off and cooled to room temperature.
- 12.2.3 Remove the old column by unscrewing the two side screws on the mounting plate.
- 12.2.4 Remove the injection port slide, and the injection block.
- 12.2.5 Release the TC gas line from the side of the block.
- 12.2.6 Remove the syringe from under the 4 port valve.
- 12.2.7 Rinse the syringe and replace the old plunger and tip with a new plunger and tip.
- 12.2.8 Remove the old mist trap filter ball and replace with a new filter, taking care not to touch with bare fingers.
- 12.2.9 Remove the ultra pure water trap, rinse well, and return. There is no need to fill with water.
- 12.2.10 The catalyst and the cupric oxide may be used straight from the bottle, but it is recommended that each be pre-combusted between 680° and 850° C for 90 minutes. This reduces the time needed to condition the column. Left over pre-combusted catalyst and cupric oxide may be stored in a desiccator.
- 12.2.11 Place 2 platinum screens in the bottom of the column. Cover with a very thin layer of quartz wool. Note: pressure problems may arise if the quartz wool is too thick.
- 12.2.12 Pour 120 mm of catalyst into the tube. Top with 2-4 mm of cupric oxide. Note: The CuO is used to prevent back splashing of the vaporized sample, which causes doublet peaks.
- 12.2.13 Smear a thin layer of high vacuum silicone grease 1-2 mm below the top of the column. Set aside.
- 12.2.14 Remove the old orings from the top of the injection block. Rinse the block. Put a thin layer of silicone grease on the new black oring and put into place. Lay a new (white) Teflon oring on top. Do not grease. Note: the Teflon coated oring on the underside of the injection block needs to be replaced twice yearly.
- 12.2.15 Remove the injection needle from the injection slide. Rinse the slide, Replace with a new needle (remove the wire from inside the new needle). Adjust the needle so that only a millimeter or so is showing through the slide, and then tighten the knurled nut. The tip of the needle should not be visible when holding the slide on a horizontal plane. It will score the Teflon oring if it is out too far.
- 12.2.16 Slide the air tubing back onto the needle.
- 12.2.17 Insert the column into the bottom of the injection block. Place into the furnace opening, making sure that the drain

tube is properly aligned. Insert into the cooling coil and hand tighten. Note: the TOC5000 requires new Teflon ferrules at this point.

- 12.2.18 Adjust the column height with mounting plate screws. On the 5000, allow enough space to slide a folded piece of paper underneath the coil. On the 5000A, adjust the height by the bottom platform.
- 12.2.19 Return the TC gas line to its proper position.
- 12.2.20 Secure the injection port slide.
- 12.2.21 Return the syringe to its proper position.
- 12.2.22 Turn gas and instrument on. Liquid in the IC block should bubble. If not, check and tighten everything that was loosened.
- 12.2.23 Turn the furnace on. Refer to Section 11.1 for TOC5000, using Curve #1, and Section 11.2 for TOC5000A instrument instructions, using the file COLCOND.CAL and COLCOND.MET.
- 12.2.24 Fill auto-sampler tubes 1-78 with ASTM Type I water, and acidify with 100 μ l 2N HCl. Acidify the water in position S1 standard cup with 300 μ l 2N HCl.
- 12.2.25 Pull up the maintenance screen and do a Zero Point Detection.
- 12.3 Semi-annual maintenance:
 - 12.3.1 Replace the Teflon coated oring.
 - 12.3.2 Replace the NaOH solution in the humidifier with a 0.3N NaOH solution: 1.2 g NaOH/100 ml H₂O.
- 12.4 Annual maintenance:
 - 12.4.1 Replace the halogen scrubber and acrodisc filter.
 - 12.4.2 Replace the soda lime scrubber.
 - 12.4.3 Replace the 4 port valve.
 - 12.4.4 If not used frequently, replace the IC port orings and needle. If used regularly, follow the monthly schedule.
 - 12.4.5 Replace the cooling coil.
 - 12.4.6 Replace the ASI needles.
- 12.5 Pollution Prevention and Waste Management:
 - 12.5.1 Liquids generated by this method are safe to put down the sink.
 - 12.5.2 Spent catalyst may be disposed of in the trash.
 - 12.5.3 Spent CO₂ absorber (Soda Lime) must be disposed in a proper manner. It should be taken to the Storage Facility on campus to be dealt with as hazardous waste.

13.0 References:

- 13.1 EPA Method 415.1. Determination of Total Organic Carbon in Water using Combustion or Oxidation.
- 13.2 Sugimura, Y. and Y. Suzuki. 1988. A high temperature catalytic oxidation method for the determination of non-volatile dissolved organic carbon in seawater by direct injection of a liquid sample. Mar. Chem. 24:105-131.

Determination of Carbon and Nitrogen in Particulates and Sediments of Fresh/Estuarine/Coastal Waters, Plant and Animal Tissue, and Soils Using Elemental Analysis

1. SCOPE and APPLICATION

- 1.1. Elemental analysis is used to determine particulate carbon (PC), and particulate nitrogen (PN) in fresh, estuarine and coastal waters and sediments as well as for plant and animal tissue and soils. The method measures the PC and PN irrespective of source (organic or inorganic.)
- 1.2. A Method Detection Limit (MDL) of 0.0759 mg C/l and 0.0123 mg N/l, for filtered samples, and 0.130 %C and 0.008% N for sediment samples, were determined using three times the standard deviation of seven replicates.
- 1.3. The quantitation limit was set at 0.253 mg C /L and 0.041 mg N/l, or ten times the standard deviation of the MDL calculation.
- 1.4. This procedure should be used by analysts experienced in the theory and application of elemental analysis. A minimum of 3 months experience with an elemental analyzer is recommended.
- 1.5. This method is for use by all programs that require analysis of particulate carbon and nitrogen in water and sediment, soils and tissues. The need to determine the organic fraction of the total particulate carbon and nitrogen in samples depends on the data-quality objectives of the study. Section 11.2.5 outlines the procedure used to ascertain the organic fraction.

2. SUMMARY

- 2.1. In the Exeter Analytical, Inc. Model CE-440 Elemental Analyzer, the carbon and nitrogen content in organic and inorganic compounds can be determined. Combustion of the sample occurs in pure oxygen under static conditions. The combustion train and analytical system are shown below in the CE-440 flow diagram. Helium is used to carry the combustion products through the analytical system to atmosphere, as well as for purging the instrument. Helium was selected for this purpose because it is chemically inert relative to tube packing chemicals, and it has a very high coefficient of thermal conductivity. The products of combustion are passed over suitable reagents in the combustion tube to assure complete oxidation and removal of undesirable by-products such as sulfur, phosphorus and halogen gases. In the reduction tube, oxides of nitrogen are converted to molecular nitrogen and residual oxygen is removed. In the mixing volume the sample gasses are thoroughly homogenized at precise volume, temperature, and pressure. This mixture is released through the sample volume into the thermal conductivity detector. Between the first of three pairs of thermal conductivity cells an absorption trap removes water from the sample gas. The differential signal read before and after the trap reflects the water concentration and, therefore, the amount of hydrogen in the original sample. A similar measurement is made of the signal output of a second pair of thermal conductivity cells, between which a trap removes carbon dioxide,

thus determining the carbon content. The remaining gas now consists only of helium and nitrogen. This gas passes through a thermal conductivity cell and the output signal is compared to a reference cell through which pure helium flows. This gives the nitrogen concentration.

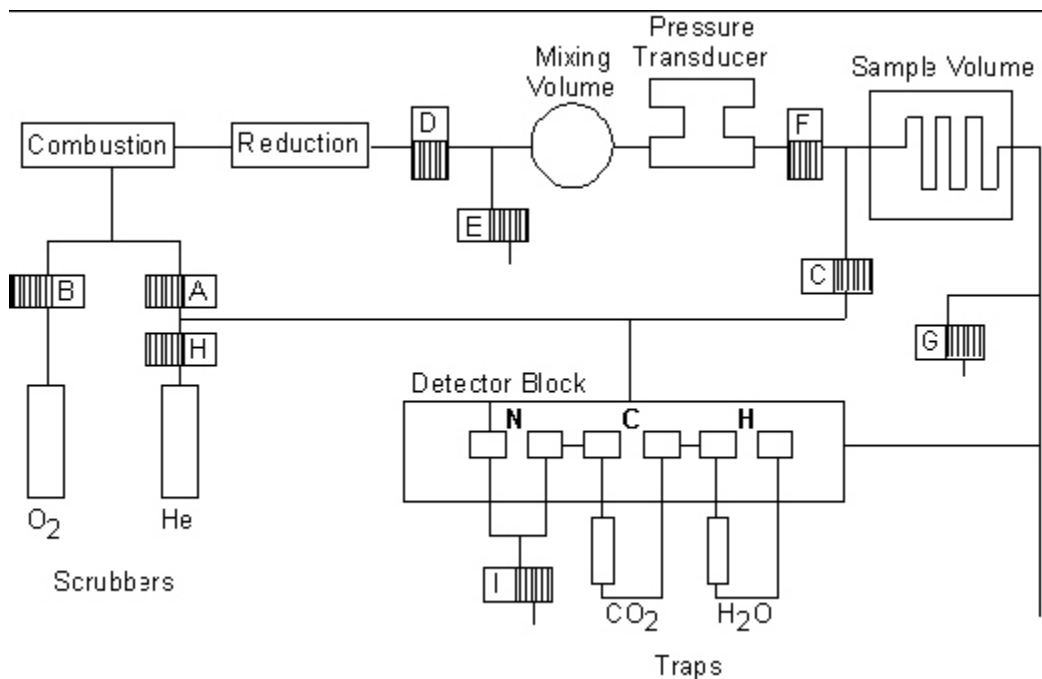

Schematic diagram of the Exeter Analytical, Inc. (EAI) CE-440 Elemental Analyzer

3. DEFINITIONS

- 3.1. **Acceptance Criteria** - Specified limits placed on characteristics of an item, process, or service defined in a requirement document. (ASQC)
- 3.2. **Accuracy** - The degree of agreement between an observed value and an accepted reference value. Accuracy includes a combination of random error (precision) and systematic error (bias) components which are due to sampling and analytical operations; a data quality indicator. (QAMS)
- 3.3. **Aliquot** - A discrete, measured, representative portion of a sample taken for analysis. (EPA QAD Glossary)
- 3.4. **Batch** - Environmental samples, which are prepared and/or analyzed together with the same process and the same personnel using the same lot(s) of reagents. A preparation batch is composed of one to 20 environmental samples of the same matrix, meeting the above mentioned criteria and with a maximum time between the start of processing of the first and last sample in the batch to be 24 hours. An analytical batch is composed of prepared environmental samples (extracts,

- digestates, or concentrates) and/or those samples not requiring preparation, which are analyzed together as a group using the same calibration curve or factor. An analytical batch can include samples originating from various environmental matrixes and can exceed 20 samples. (NELAC/EPA)
- 3.5. **Blank** - A sample that has not been exposed to the analyzed sample stream in order to monitor contamination during sampling, transport, storage or analysis. The blank is subjected to the usual analytical and measurement process to establish a zero baseline or background value and is sometimes used to adjust or correct routine analytical results. (ASQC)
 - 3.5.1. **Blank** - Blank value = blank read minus blank zero. An indicator of the stability of the system. (Exeter)
 - 3.6. **Bridge** - Electrical configuration of the thermal conductivity filaments.(Exeter)
 - 3.7. **Calibrate** - To determine, by measurement or comparison with a standard, the correct value of each scale reading on a meter or other device, or the correct value for each setting of a control knob. The levels of the applied calibration standard should bracket the range of planned or expected sample measurements. (NELAC)
 - 3.8. **Calibration** - The set of operations which establish, under specified conditions, the relationship between values indicated by a measuring device. The levels of the applied calibration standard should bracket the range of planned or expected sample measurements. (NELAC)
 - 3.9. **Calibration Method** - A defined technical procedure for performing a calibration. (NELAC)
 - 3.10. **Calibration Standard** - A substance or reference material used to calibrate an instrument. (QAMS)
 - 3.10.1. **Initial Calibration Standard (CAL)** - An accurately weighed amount of a certified chemical used to calibrate the instrument response with respect to analyte mass. For this procedure the calibration standard is acetanilide, 99.9%+ purity. It has known percentages of C, H, and N.
 - 3.10.2. **Initial Calibration Verification (ICV)** - An individual standard, analyzed initially, prior to any sample analysis, which verifies acceptability of the calibration curve or previously established calibration curve.
 - 3.10.3. **Continuing Calibration Verification (CCV)** - An individual standard which is analyzed after every tenth field sample analysis.
 - 3.11. **Capsule** - Aluminum container. Used for containing samples and standards with an accurate weight and maintains integrity prior to combustion.
 - 3.12. **Certified Reference Material** - A reference material one or more of whose property values are certified by a technically valid procedure, accompanied by or traceable to a certificate or other documentation which is issued by a certifying body. (ISO 17025)
 - 3.13. **Combustion Time** - Time for sample to fully combust in an oxygen environment.
 - 3.14. **Combustion Tube** - Quartz tube packed with reagents and used for sample combustion.
 - 3.15. **Conditioner** - A standard chemical which is not necessarily accurately weighed that is used to coat the surfaces of the instrument with the analytes (water vapor, carbon dioxide, and nitrogen).

- 3.16. **Corrective Action** - Action taken to eliminate the causes of an existing nonconformity, defect or other undesirable situation in order to prevent recurrence. (ISO 8402)
- 3.17. **Deficiency** - An unauthorized deviation from acceptable procedures or practices. (ASQC)
- 3.18. **Demonstration of Capability** - A procedure to establish the ability of the analyst to generate acceptable accuracy. (NELAC)
- 3.19. **Detection Limit** - The lowest concentration or amount of the target analyte that can be determined to be different from zero by a single measurement at a stated degree of confidence.
- 3.20. **Detector** - The heart of the analyzer consisting of three bridges. Determines the percentages of carbon, hydrogen, and nitrogen in the sample via thermal conductivity.
- 3.21. **Detector Oven** - Keeps the temperature of the detector, pressure transducer, mixing volume, and sample volume constant.
- 3.22. **Double Drop** - Two samples are dropped for one run - used for filter and inorganic applications. Sample requires a + prefix.
- 3.23. **Duplicate Analyses** - The analyses or measurements of the variable of interest performed identically on two sub samples (aliquots) of the same sample. The results from duplicate analyses are used to evaluate analytical or measurement precision but not the precision of sampling, preservation or storage internal to the laboratory (EPA-QAD)
- 3.24. **External Standard (ES)** - A pure analyte (atropine) that is measured in an experiment separate from the experiment used to measure the analyte(s) in the sample. The signal observed for a known quantity of the pure external standard is used to calibrate the instrument response for the corresponding analyte(s). The instrument response is used to calculate the concentrations of the analyte(s) in the unknown sample.
- 3.25. **Field Duplicates (FD1 and FD2)** - Two separate samples collected at the same time and place under identical circumstances and treated exactly the same throughout field and laboratory procedures. Analyses of FD1 and FD2 give a measure of the precision associated with sample collection, preservation and storage, as well as with laboratory procedures.
- 3.26. **Fill Time** - Time required to build-up the pressure in the mixing volume to 1500 mm Hg.
- 3.27. **Filtered Sample** - An accurately measured amount of water from fresh, estuarine or coastal samples, concentrated on a filter pad by filtering through a 25 mm Whatman GF/F filter or equivalent, which has been precombusted at 500° C for 90 minutes.
- 3.28. **Furnace** - Heats the reduction and combustion tubes to operating temperature.
- 3.29. **Heated Line** - Connects the reduction tube outlet to the inlet of the mixing volume. Heated to prevent condensation of gases on tube walls.
- 3.30. **Holding Time** - The maximum time which samples may be held prior to analysis and still be considered valid. (40 CFR Part 136) The time elapsed from the time of sampling to the time of extraction or analysis, as appropriate.

- 3.31. **Inject Solenoid** - Solenoid used on the automated injection system to actuate the rotation of the sample wheel.
- 3.32. **Injection** - Moving the ladle, containing a capsule with the sample into the combustion furnace.
- 3.33. **Injector Box** - The box assembly that houses the sample wheel.
- 3.34. **Instrument Detection Limit (IDL)** - The minimum quantity of analyte or the concentration equivalent which gives an analyte signal equal to three times the standard deviation of the background signal at the selected wavelength, mass, retention time, absorbance line, etc.
- 3.35. **K-Factor** - Instrument sensitivity factor in microvolts per microgram, calibrated using an external standard.
- 3.36. **Laboratory Duplicates (LD1 and LD2)** - Two aliquots of the same sample taken in the laboratory and analyzed separately with identical procedures. Analyses of LD1 and LD2 indicate precision associated with laboratory procedures, but not with sample collection, preservation, or storage procedures.
- 3.37. **Laboratory Reagent Blank (LRB)** - A matrix blank (i.e., a precombusted filter or sediment capsule) that is treated exactly as a sample including exposure to all glassware, equipment, solvents, and reagents that are used with other samples. The LRB is used to determine if method analytes or other interferences are present in the laboratory environment, the reagents, or the apparatus.
- 3.38. **Laboratory Control Sample (LCS)** - A sample matrix, free from the analytes of interest, spiked with verified known amounts of analytes from a source independent of the calibration standards or a material containing known and verified amounts of analytes. The LCS is generally used to establish intra-laboratory or analyst-specific precision and bias or to assess the performance of all or a portion of the measurement system. (NELAC)
- 3.39. **Ladle** - Transports the capsule with the sample into a combustion furnace
- 3.40. **Limit of Detection (LOD)** - The lowest concentration level that can be determined by a single analysis and with a defined level of confidence to be statistically different from a blank. (ACS)
- 3.41. **Limit of Quantitation (LOQ)** - The minimum levels, concentrations, or quantities of a target variable (target analyte) that can be reported with a specified degree of confidence. The LOQ is set at 3 to 10 times the LOD, depending on the degree of confidence desired.
- 3.42. **Linear Dynamic Range (LDR)** - The absolute quantity over which the instrument response to an analyte is linear. This specification is also referred to as the Linear Calibration Range (LCR).
- 3.43. **Material Safety Data Sheet (MSDS)** - Written information provided by vendors concerning a chemical's toxicity, health hazards, physical properties, fire, and reactivity data including storage, spill, and handling precautions.
- 3.44. **May** - Denotes permitted action, but not required action. (NELAC)
- 3.45. **Method Detection Limit (MDL)** - The minimum concentration of an analyte that can be identified, measured, and reported with 98% confidence that the analyte concentration is greater than zero.
- 3.46. **Mixing Volume** - Spherical bottle in which sample gases become homogenous.

- 3.47. **Mother Board** - The main printed circuit board. All CE 440 power supplies are located here.
- 3.48. **Must** - Denotes a requirement that must be met. (Random House College Dictionary)
- 3.49. **Precision** - The degree to which a set of observations or measurements of the same property, obtained under similar conditions, conform to themselves; a data quality indicator. Precision is usually expressed as standard deviation, variance or range, in either absolute or relative terms. (NELAC)
- 3.50. **Preservation** – Refrigeration, freezing and/or reagents added at the time of sample collection (or later) to maintain the chemical and or biological integrity of the sample.
- 3.51. **Pressure Transducer** - Used to check for leaks in the system and to monitor pressure in the mixing volume.
- 3.52. **P Valve** - The valve on the injector box of the horizontal auto-injector (HA) used to automatically purge the box.
- 3.53. **Profile** - Generated by the bridge signal. Used to help determine if a leak or malfunction occurs in the system.
- 3.54. **Quality Control Sample (QCS)** - A sample of analytes of known and certified concentrations. The QCS is obtained from a source external to the laboratory and different from the source of calibration standards. It is used to check laboratory performance with externally prepared test materials.
- 3.55. **Reduction Tube** - Quartz tube with reduced copper that removes excess oxygen from the sample gas and reduces oxides of nitrogen to free nitrogen.
- 3.56. **Response Factor (RF)** - The ratio of the response of the instrument to a known amount of analyte.
- 3.57. **Run** - One sample analysis from start to finish, including printout.
- 3.58. **Run Cycle** - Typically a day or half day of operation - the entire analytical sequence of runs from the first run to the last run on the Sample Wheel.
- 3.59. **Sample Volume** - Tube where sample gas is exhausted from the mixing volume prior to entering the detector.
- 3.60. **Sample Wheel** – Sample holding device which contains up to 64 blanks, standards and samples. One wheel equals roughly 6 hours of run time, which is called the Run Cycle.
- 3.61. **Scrubber** - Removes water and CO₂ from the gas supplies.
- 3.62. **Sediment (or Soil) Sample** - A fluvial, sand, or humic sample matrix exposed to a marine, estuarine or fresh water environment.
- 3.63. **Sensitivity** - The capability of a test method or instrument to discriminate between measurement responses representing different levels (concentrations) of a variable of interest.
- 3.64. **Shall** - Denotes a requirement that is mandatory whenever the criterion for conformance with the specification requires that there be no deviation. (ANSI)
- 3.65. **Should** - Denotes a guideline or recommendation whenever noncompliance with the specification is permissible. (ANSI)
- 3.66. **Sleeve - Nickel** - to maintain integrity of the sample capsule and to protect the quartz ware from devitrification (to destroy the glassy qualities by prolonged heating).

- 3.67. **Standard Reference Material (SRM)** - Material which has been certified for specific analytes by a variety of analytical techniques and/or by numerous laboratories using similar analytical techniques. These may consist of pure chemicals, buffers, or compositional standards. The materials are used as an indication of the accuracy of a specific analytical technique.
- 3.68. **Trap** - Used for removing water and CO₂ from the sample gas.
- 3.69. **Tissue sample** – Plant or animal tissue dried and ground ready for weighing.
- 3.73 **Zero Value** - Bridge signal with only pure helium flowing through the detector.

4. INTERFERENCES

- 4.1. There are no known interferences for fresh, estuarine or coastal water or sediment samples. The presence of C and N compounds on laboratory surfaces, on fingers, in detergents and in dust necessitates the utilization of careful techniques (i.e., the use of forceps and gloves) to avoid contamination in every portion of this procedure (EPA.)

5. SAFETY

- 5.1. Safety precautions must be taken when handling reagents, samples and equipment in the laboratory. Protective clothing including lab coats and safety glasses and enclosed shoes must always be worn. In certain situations it may also be necessary to use gloves and goggles. If solutions or chemicals come in contact with eyes, flush with water continuously for 15 minutes. If solutions or chemicals come in contact with skin, wash thoroughly with soap and water. Contact Solomons Rescue Squad (911) if emergency treatment is needed and also inform the CBL Business Manager of the incident. Contact the CBL Business Manager if additional treatment is required.
- 5.2. The toxicity or carcinogenicity of each reagent used in this procedure may not have been fully established. Each chemical should be regarded as a potential health hazard and exposure should be as low as reasonably achievable. Cautions are included for known extremely hazardous materials and procedures.
- 5.3. High current and voltages are exposed near the furnaces, furnace control card, and mother board even while the 440 is OFF. If non-electrical trouble shooting is desired, remove the 440 line cord from the wall receptacle.
- 5.4. The combustion tube is brittle since it is fused quartz. Do not put any unnecessary stress on it.
- 5.5. The exterior of the furnace becomes extremely hot; do not touch it or the heat shield unless wearing appropriate gloves.
- 5.6. Do not wear any jewelry if electrically troubleshooting. Even the low voltage points are dangerous and can injure is allowed to short circuit.
- 5.7. The following hazard classifications are listed for the chemicals regularly used in this procedure.

Chemical	Health	Flammability	Reactivity	Contact	Storage
Acetanilide	1	1	0	2	Green
Atropine	1	1	0	2	Green
Magnesium Perchlorate	1	0	3	2	Yellow
Ascarite	3	0	2	4	White Stripe
Silver vanadate on Chromosorb	3	0	0	3	White
Silver oxide/Silver tungstate on Chromosorb	3	0	0	3	White
Silver tungstate/Magnesium oxide on Chromosorb	3	0	0	3	White
Copper wire	0	0	0	1	Green
On a scale of 0 to 4 the substance is rated on four hazard categories: health, flammability reactivity, and contact. (0 is non-hazardous and 4 is extremely hazardous)					
STORAGE Red - Flammability Hazard. Store in a flammable liquid storage area. Blue - Health Hazard. Store in a secure poison area. Yellow - Reactivity Hazard. Keep separate from flammable and combustible materials. White - Contact Hazard. Store in a corrosion-proof area. Green - Use general chemical storage (On older labels, this category was orange). Striped - Incompatible materials of the same color class have striped labels. These Products should not be stored adjacent to substances with the same color label. Proper storage must be individually determined.					

6. EQUIPMENT AND SUPPLIES

- 6.1. An elemental analyzer capable of maintaining a combustion temperature of 975°C and analyzing particulate and sediment samples for elemental carbon and nitrogen. The Exeter Model 440 is used in this laboratory.
- 6.2. A gravity convection drying oven, capable of maintaining 47°C ± 2°C for extended periods of time.
- 6.3. Muffle furnace, capable of maintaining 875°C +/- 15°C.
- 6.4. Ultra-micro balance that is capable of accurately weighing to 0.1 ug.
- 6.5. Vacuum pump or source capable of maintaining up to 10 in. Hg of vacuum.
- 6.6. Freezer, capable of maintaining -20°C ± 5°C.
- 6.7. 25-mm vacuum filter apparatus made up of a glass filter tower, fritted glass disk base and 2-L vacuum flask.
- 6.8. Flat blade forceps.
- 6.9. Labware - All reusable labware (glass, quartz, polyethylene, PTFE, FEP, etc.) must be sufficiently clean for the task objectives. Clean glassware by rinsing with deionized water; soaking for 4 hours or more in 10% (v/v) HCl and then rinsing with deionized water. Store clean. All traces of organic material must be removed to prevent carbon and nitrogen contamination.

7. REAGENTS AND STANDARDS

- 7.1. **Purity of Water** – Unless otherwise indicated, references to water shall be understood to mean reagent water conforming to ASTM Specification D 1193, Type I.

- 7.2. **Purity of Reagents** – Reagent grade chemicals shall be used in all tests. Unless otherwise indicated, it is intended that all reagents shall conform to the specifications of the Committee on Analytical Reagents of the American Chemical Society, where such specifications are available. Other grades may be used, provided it is first ascertained that the reagent is of sufficiently high purity to permit its use without lessening the accuracy of the determination.
- 7.3. **Acetanilide, 99.9% + purity**, C_8H_9NO (CASRN 103-84-4) - Primary standard
- 7.4. **Blanks** – Three blanks are used for the analysis. Two blanks are instrument related. The instrument zero response (ZN) is the background response of the instrument without sample holding devices such as capsules and sleeves. The instrument blank response (BN) is the response of the instrument when the sample capsule, sleeve and ladle are inserted for analysis without standard or sample. The BN is also the laboratory reagent blank (LRB) for standards and sediment or other weighed samples. The LRB for water samples includes the sleeve, ladle and a precombusted filter without standard or sample. These blanks are subtracted from the uncorrected instrument response used to calculate concentration. The third blank is the laboratory fortified blank (LFB.) For sediment or other weighed sample analysis, a weighed amount of acetanilide or other standard is placed in an aluminum capsule and analyzed. For aqueous samples, a weighed amount of acetanilide or other standard is placed on a glass fiber filter the same size as used for sample filtration, and analyzed.
- 7.5. **Quality Control Sample (QCS)** – For this procedure, the QCS can be any assayed and certified sediment or particulate sample which is obtained from an external source. BCSS-1 from the National Research Council of Canada is used by this laboratory.

8. SAMPLE COLLECTION, PRESERVATION AND STORAGE

- 8.1. **Water Sample Collection** – Samples collected for PNC analysis from fresh, estuarine and coastal waters are normally collected from a boat or pier using one of two methods; hydrocast or submersible pump systems. Follow the recommended sampling protocols associated with the method used. Whenever possible, immediately filter the samples as described in Section 11.1.1. Store the filtered sample in a labeled aluminum foil pouch and freeze at $-20^{\circ}C$ or store in a low temperature ($47^{\circ}C$) drying oven after drying at $47^{\circ}C \pm 2^{\circ}C$, until use. If storage of the unfiltered water sample is necessary, place the sample into a clean bottle and store at $4^{\circ}C$ until filtration is performed. Dry samples in a low temperature ($47^{\circ}C \pm 2^{\circ}C$) drying oven prior to analysis.
- 8.2. The volume of water sample collected will vary with the type of sample being analyzed. Table 1, see 8.3.2., provides a guide for a number of matrices of interest. If the matrix cannot be classified by this guide, collect 1 L of water from each site.
- 8.3. **Sediment, Tissue, or Soil Sample Collection** – Sediment samples are collected with benthic samplers. The type of sampler used will depend on the type of sample needed by the data-quality objectives. Tissue and soil samples are collected by a variety on methods. Store the wet sample in a clean labeled jar and freeze at $-20^{\circ}C$

until ready for analysis. Dry samples in a low temperature ($47^{\circ}\text{C} \pm 2^{\circ}\text{C}$) drying oven, and grind to a homogenous powder with a mortar and pestle, prior to analysis.

8.3.1. The amount of solid material collected will depend on the sample matrix. A minimum of 1 g is recommended.

8.3.2. Filtration Volume Selection Guide

Sample Matrix	25mm Filter
Open Ocean	500 – 1000 ml
Coastal	400 – 500 ml
Estuarine (Low particulate)	250 – 400 ml
Estuarine (High Particulate)	25 – 200 ml

9. QUALITY CONTROL

9.1. The laboratory is required to operate a formal quality control (QC) program. The minimum requirements of this program consist of an initial demonstration of laboratory capability and the continued analysis of laboratory instrument blanks field duplicates, and calibration standards analyzed as samples as a continuing check on performance. The laboratory is required to maintain performance records that define the quality of data generated.

9.2. Initial Demonstration of Capability

9.2.1. **The initial demonstration of capability (DOC)** – is used to characterize instrument performance (MDLs) and laboratory performance (analysis of QC samples) prior to the analyses conducted by this procedure.

9.2.2. **Quality Control Sample (QCS/SRM)** – When using this procedure, a quality control sample is required to be analyzed at the beginning or middle and end of the run, to verify data quality and acceptable instrument performance. If the determined concentrations are not within $\pm 10\%$ of the certified values, performance of the determinative step of the method is unacceptable. The source of the problem must be

identified and corrected before proceeding with the initial determination of MDLs.

- 9.2.3. **Method Detection Limits (MDLs)** – MDLs should be established for PC and PN using a low level estuarine water sample, typically three to five times higher than the estimated MDL. The same procedure should be followed for sediments or other weighed samples. To determine the MDL values, analyze seven replicate aliquots of water or sediment and process through the entire analytical procedure. Perform all calculations defined in the procedure (Section 12) and report the concentration values in the appropriate units. Calculate the MDL as follows:

$$\text{MDL} = 3 \times S$$

Where, S = Standard deviation of the replicate analyses.

- 9.2.4. MDLs should be determined annually, whenever there is a significant change in instrumental response, change of operator, or a new matrix is encountered.

9.3. Assessing Laboratory Performance

- 9.3.1. **Laboratory Reagent Blank (LRB)** – The laboratory must analyze at least one LRB (Section 3.40) with each batch of samples. For sediment samples the LRB consists of the ladle, sample sleeve and sample capsule, as there are no reagents involved in this procedure. For aqueous samples the LRB is a precombusted filter of the same type and size used for samples. LRB data are used to assess contamination from the laboratory environment. For sediment samples, the blank value for carbon should not exceed 150 uv and the blank value for nitrogen should not exceed 50 uv. For aqueous samples, the blank value for carbon should not exceed 375 uv and the blank value for nitrogen should not exceed 50 uv.

- 9.3.1.1. If the nitrogen blank during a BLANK analysis is in excess of 2000% the nitrogen blank in memory the “COPPER APPEARS SPENT” is printed. If the nitrogen blank increased over 100 uv over BN in memory and the first STANDARD KC/KN is more than any following STANDARD KC/KN by 0.2 uv/ug, then a “COPPER APPEARS SPENT” warning will be printed either during a BLANK analysis or a STANDARD analysis.

- 9.3.2. **Quality Control Sample (QCS)/ Standard Reference Material (SRM)** - When using this procedure, a quality control sample is required to be analyzed at the beginning and end of the run, to verify data quality and acceptable instrument performance. If the determined concentrations are not within $\pm 3\sigma$ of the certified values, performance of the determinative step of the method is unacceptable. The source of the problem must be identified and corrected before either proceeding with the initial determination of MDLs or continuing with the analyses. Corrective action documentation is required for all data outside $\pm 3\sigma$. The sample weight of the SRM should mirror that of the unknown samples (~10 mg).

9.3.3. The laboratory must use QCS analyses data to assess laboratory performance against the required accuracy control limits of $\pm 3\sigma$. The QCS will be obtained from a source external to the laboratory and different from the source of calibration standards. The standard deviation data should be used to establish an on-going precision statement for the level of concentrations included in the QCS. This data must be kept on file and be available for review. Values for QCSs should be plotted with the other control data.

9.4. Assessing Analyte Recovery

9.4.1. Percent recoveries cannot be readily obtained from particulate samples. Consequently, accuracy can only be assessed by analyzing check standards as samples and quality control samples (QCS).

9.5. Data Assessment and Acceptance Criteria for Quality Control Measures

INDICATOR	ACCEPTANCE LIMITS	ACTION
K-factor	KC = 18 to 25 $\pm 3\sigma$ 18 to 25 $\mu\text{v}/\mu\text{g}$ is manufacturers recommended limits. KN = 7 to 10 $\mu\text{v}/\mu\text{g}$ 7 to 10 $\mu\text{v}/\mu$ is manufactures recommended limits.	The k-factors must be within the specified limits or the standard must be reanalyzed. (see 10.3)
System Blank	BC < 150 μv BN < 50 μv	If the blank value is greater the acceptable value, replace the capsules and rerun the blanks.
External QC (QCS) start or middle and end of run cycle	$\pm 3\sigma$	Qualify data if not within acceptance limits. Rejection criteria for batch.
Standard Reference Material (SRM) (when required by data user)	$\pm 3\sigma$	If SRM is outside acceptance limits, qualify the data for all samples back to last acceptable SRM or QCS.
Duplicate analysis (when available)	$\pm 50\%$	Duplicate sample data must be within $\pm 50\%$ or be qualified. All duplicates for this procedure are field duplicates and are more a measure of field collection and filtration techniques.

9.6. Corrective Actions for Out-Of-Control Data

9.6.1. All samples must be qualified when external QC samples are out of control.

9.6.2. All samples between QCSs that are out of control must be qualified.

9.6.3. All problems with analytical runs must be documented on the bench sheet.

9.7. General Operation

9.7.1. To assure optimal operation and analytical results, it is advisable to track the stability of the instrument. Of primary importance is the precision and repeatability of standard and blank values during the course of a day of operation. Thus, a standard (as an unknown) should be inserted approximately every twenty runs. Try to use different

standards for QA in order to assure the validity of the calibration values over the entire operating range of the instrument.

10. CALIBRATION, STANDARDIZATION and CALCULATIONS

10.1.1. Calibration - Daily calibration procedures must be performed and evaluated before sample analysis may begin. Single point calibration is used with the Exeter Model 440 Analyzer.

10.1.2. Establish single calibration factors (K) for each element (carbon, hydrogen, and nitrogen) by analyzing three weighed portions of calibration standard (acetanilide). The mass of the calibration standard should provide a response within 20% of the response expected for the samples being analyzed. Calculate the (K) for each element using the following formula:

$$K - factor (\mu v / \mu g) = \frac{RN - ZN - BN}{M(T)}$$

Where: RN = Instrument response to standard (μv)
 ZN = Instrument zero response (μv)
 BN = Instrument blank response (μv)
 M = Mass of standard matter in μg
 T = Theoretical % C, N, or H in the standard. For acetanilide %C = 71.09, %N = 10.36 and %H = 6.71.

10.2. The detector generates a signal directly proportional to the compound of interest in the sample. The following formula is used to calculate carbon, nitrogen and hydrogen concentrations in unknown samples.

$$\% = \frac{1}{K} \times \frac{1}{W} \times (R - Z - B) \times 100$$

Where

K = calibration factor for the 440 instrument
 W = sample weight
 R = read signal of sample gas
 Z = zero reading or base line of instrument
 B = blank signal generated by instrument itself, including ladle and capsules

10.3. The K-factor is established by running samples of a known standard. The default value is for acetanilide, which we will use for our standard:

Acetanilide C = 71.09% H = 6.71% N = 10.36%

If another standard is used, the values will need to be entered into the computer using The Edit Standards function in the Customizing Menu.

10.3.1. Once the blank values have been established and entered into memory, proceed to run known standards to arrive at the calibration factors for carbon and nitrogen for the instrument.

10.3.2. Run a minimum of three standards, average the results, and enter into computer memory, or use the automatic enter mode. During the run, standards may be entered as samples to verify the K-factors and blanks.

10.3.3. Any time a STD1 is entered as sample ID the computer calculates and enters a new set of operating Ks based on a weighted formula using the last three sets of Ks in memory. This occurs only if all three Ks fall within the following windows:

$$\text{New KC} = \text{KC in memory} \pm 1.0$$

$$\text{KN} = \text{KN in memory} \pm 0.5$$

10.3.3.1. It is important that the Ks in memory be close to expected values or new Ks generated will not be within the window and therefore will not be accepted for automatic insertion.

10.3.3.2. The weighted formula for calculating the Ks:

$$K = k^1 + (0.5 \times k^2) + \frac{(0.25 \times k^3)}{1.75}$$

where:

k^1 = k found in this run

k^2 = Next k in memory

k^3 = Last k in memory

10.4. **Conditioner** - Before running any samples or blanks, it is necessary to run one or more conditioners. The purpose of the conditioner runs is to coat the walls of the system surfaces, especially the mixing and sample volume, with water vapor, carbon dioxide and nitrogen which simulates actual sample running conditions. To simulate this condition as closely as possible, it is advisable to use conditioners of approximately the same weight as the samples to the run.

10.5. **Blanks** - The blank values used in the calculation is the total signal generated by the system including the ladle and sample capsule. This blank should always be run immediately after a weighed conditioner to represent a true blank of the instrument. Never use the blank value after an empty run since the system dries up and the blank value would be lower than normal.

10.5.1. The blanks will only be accepted if they fall within the following:

$$\text{New BC} < 500$$

$$\text{New BN} < 250$$

10.6. **K-Factors** - Once the blank values have been established and entered into memory, proceed to run known standards in order to establish the calibration factors for carbon, hydrogen and nitrogen. Always run a conditioner before a standard. The computer will calculate K-factors as long as STD# has been entered as the sample ID. Run a minimum of three (3) standards, average the results, and enter into the computer memory, or use the automatic enter mode. The instrument is now ready for running samples. Standards should be analyzed as unknowns during each run to verify the K-factors and blank values.

11. PROCEDURE

11.1. Aqueous Sample Preparation

11.1.1. Water Sample Filtration

Precombust 25-mm GF/F glass fiber filters at 500°C for 1.5 hours. Store filters covered, if not immediately used. Place a precombusted filter on a fritted filter base of the filtration apparatus and attach the filtration tower. Thoroughly shake the sample container to suspend the particulate matter. Measure and record the required sample volume using a graduated cylinder. Pour the measured sample into the filtration tower. Filter the sample using a vacuum no greater than 10 in. of Hg. Vacuum levels greater than 10 in. of Hg can cause cell rupture. Do not rinse the filter following filtration. It has been demonstrated that sample loss occurs when the filter is rinsed with an isotonic solution or the filtrate. Air dry the filter after the sample has passed through by continuing the vacuum for 30 sec. Using flat-tipped forceps, fold the filters in half while still on the fritted glass base of the filter apparatus. Store filters as described in Section 8.1.

11.1.2. If the sample has been stored frozen in foil pouches, place in a drying oven at 47°C ± 2°C for 24 hours before analysis. Slightly open the pouch to allow drying. When ready to analyze, fold, and insert the filter into a precombusted nickel sleeve using forceps. Tap the filter pad down into the nickel sleeve using a stainless steel rod. The sample is ready for analysis.

11.2. Sample Analysis

11.2.1. As the filters are packed into the nickel sleeves they are placed into the 64 position sample wheel. The calibration series must be placed at the beginning of the batch. The sample schedule consists of a conditioner, a blank, a conditioner and three standards. ACS grade acetanilide must be used to calibrate the instrument.

11.2.2. Set up the sample tray in the following manner (used for aqueous samples):

Position #	Contents	Notes	Schedule Entry	Weight
1	Capsule + sleeve	Blank	Blank	0
2	Conditioner	Acetanilide (1500-2500 µg)	Conditioner	Weight of Acetanilide
3	Capsule + sleeve	Blank	Blank	0
4	Conditioner	Acetanilide (1500-2500 µg)	Conditioner	Weight of Acetanilide
5	Standard	Acetanilide (1500-2500 µg)	STD1 ^a	Weight of Acetanilide
6	Standard	Acetanilide (1500-2500 µg)	STD1	Weight of Acetanilide
7	Standard	Acetanilide (1500-2500 µg)	STD1	Weight of Acetanilide
8	Sleeve + filter pad	Filter Blank	LRB	0
9-31	Samples			Volume filtered/10
32	Sleeve + filter pad + standard	Atropine (1500-2500ug)	LFB	Weight of Atropine
33-61	Samples			Volume filtered/10
62	Capsule + Sleeve	Blank	Blank	0
63	Sleeve + capsule+ standard	Atropine (1500-2500ug)	LFB	Weight of Atropine
64	Capsule + Sleeve	Blank	Blank	0

^a Always use STD1 in the Standard position. The system recognizes this as acetanilide and makes the appropriate calculations for the K factor.

11.2.3. By entering volume filtered/10 for the weight of the aqueous filtered samples, results are printed out which represent micrograms of carbon or nitrogen per liter. This corresponds directly to the known amount of liquid that has passed through the filter. The maximum sample capacity per run is approximately 4,000 to 5,000 micrograms of carbon on the filter pad. Filters containing more than that amount can be cut in half and analyzed separately and the results added.

11.2.4. Filter Preparation for Analysis

11.2.4.1. Work on a clean, non-contaminating surface.

11.2.4.2. Using two pairs of clean forceps, fold the filter in half so that the exposed surface is inside. Continue folding the filter in half until you have a compact package.

11.2.4.3. Place a pre-combusted 7 x 5 mm nickel sleeve into the filter loading die, which functions as a holding device. Use the clean 4 mm loading plunger to force the compressed filter through the clean loading funnel and into the nickel sleeve.

11.2.4.4. Make sure no excess filter protrudes above the lip of the sleeve.

11.2.4.5. Place loaded sleeve in the 64-sample wheel.

11.2.5. Determination of Particulate Organic and Inorganic Carbon

11.2.5.1. Thermal Partitioning is the method used to partition organic and inorganic carbon. The difference found between replicate samples, one of which has been analyzed for total PC and PN and the other of which was muffled at 550°C for three hours to drive off organic compounds, and then analyzed for PC and PN, is the particulate organic component of that sample. This method of thermally partitioning organic and inorganic PC may underestimate slightly the carbonate minerals' contribution in the inorganic fraction since some carbonate minerals decompose below 500°C, although CaCO₃ does not. This method is used for filtered samples where at least two filters per sample must be supplied. For sediment samples at least 1 g of sample is required and at least 0.5g of sample is weighed into a crucible of known weight. The weight is recorded. The crucible is then muffled as above, and weighed again. The percent remaining of the ash is calculated and multiplied times the %C in the ash which is then determined by the 440.

12. DATA ANALYSIS AND CALCULATIONS

12.1. Raw results for each run are printed by the dot matrix printer attached to the instrument. These data are then manually entered into a LOTUS 123 spreadsheet. Results are reported in mg/L for aqueous samples, and in % for sediment or other weighed samples, standards and SRMs or QCSs.

12.2. Recalculation of data (if necessary)

12.2.1. The software gives the analyst the opportunity to recalculate values generated by the run. This option can be useful for adjusting the values of the data due to

explained or unexpected changes in the blank or calibration (K) factor during an analytical run cycle. Blanks can change due to sample handling, different capsules or sleeves, small leaks in the system and contamination. K factors should remain stable but can drift due to flow changes caused by variable pressure drops in the traps or helium scrubber, or by changing delivery pressure at the helium regulator.

12.2.2. Before the analyst can change calibration values and recalculate the results, there must be a valid reason. When data is recalculated, always document the incident.

12.3. Example of LOTUS spreadsheet of results:

	A	B	B	C	D	E
1	2/29,3/3/08					
2	Jane Doe					
3	DNR MAINSTEM SPLITS					
4	2/08					
5	SAMPLE	MG N/L	MG C/L			
6	56	0.1440	0.9520			
7	57	0.1510	0.9980			
8	58	0.1440	0.9460			
9	59	0.1430	0.9260			
10	BCSS1, 2/29	0.20	2.09	%		
11	BCSS1, 3/3	0.20	2.14	%		
12	LAB DUPS	PN		PC		
13	SAMPLE	DUP 1	DUP 2	DUP 1	DUP 2	
14	56	0.1430	0.1460	0.9360	0.9670	
15	58	0.1430	0.1450	0.9470	0.9450	
17	BLANKS N= 16		K VALUE N= 7.493			
18	C= 140		C= 20.771			
19	BLANKS N= 15		K VALUE N= 7.393			
20	C= 126		C= 20.352			
21	ATROPINE 2/29 N= 4.85 %					
22	ATROPINE 2/29 C= 70.23 %					
23	ATROPINE 3/3 N= 4.90 %					
24	ATROPINE 3/3 C= 70.35 %					

12.3.1. Cell 1A - Analysis date

12.3.2. Cell 2A – Analyst’s name

12.3.3. Cell 3A – Sample source or client

12.3.4. Cell 4A – Sample date

12.3.5. Cell 5A – Column heading for Sample

12.3.6. Cell 5B – Column heading for N concentration

- 12.3.7. Cell 5C - Column heading for C concentration.
- 12.3.8. Cells 5A to 11D – Sample Results table.
- 12.3.9. Cells 10 D and 11 D - % to indicate that BCSS-1 is reported in %N or C
- 12.1.10. Cells 12A to 15E – QC table for field duplicates. The mean of these values is reported in the sample results table.
- 12.1.11. Cells 17A to 20F – Instrument values for the Blanks, and Ks.
- 12.1.12. Cells 21A to 24B- Values for LRB (atropine) for each day of analyses and middle and end of analytical run.
- 12.2. Sample data should be reported in units of mg/L as carbon or nitrogen for aqueous samples, and as percent carbon or nitrogen for sediment samples.
- 12.3. Report analyte concentrations to three significant figures for both aqueous and sediment samples.
- 12.4. For aqueous samples, calculate the sample concentration using the following formula:
- $$\text{Concentration (mg / L)} = \frac{\text{Corrected sample response } (\mu\text{g / L})}{1000\text{mls / L}}$$
- 12.5. For sediment samples, % N or %C are already calculated by the instrument software.

13. **METHOD PERFORMANCE**

- 13.1. The procedure validation MDL, based on seven filtrations of a sample, was found to be 0.0633 mg/L for carbon and 0.0105 mg/L for nitrogen.
- 13.1. Twenty analyses of the BCSS-1 Marine Sediment QC, from 7/2007 to 3/2008, produced an average value of 2.13 +/- 0.4% C. The true value for the QC is 2.19 +/- 0.09% C. This is a mean recovery of 97.3%. The true value for %N is not given, but the value obtained by our procedure was 0.194 +/- 0.008%N.
- 13.2. Forty analyses of the LRB (acetanilide), from 7/2007 to 3/2008, produced the following values for carbon and nitrogen: The true value for carbon in acetanilide is 71.09%. The average value over the time period was 70.35% ± 0.70%. This is a mean recovery of 99.0%. The true value for nitrogen in acetanilide is 10.36%. The average value over the time period was 10.31% ± 0.10%. This is a mean recovery of 99.5%.
- 13.3. Atropine became the standard used for LRB analyses as of 3/15/08. The true value for carbon is 70.56%. The average value from 3/15-4/7/08 was 70.14 ± 0.42%. This is a mean recovery of 99.4%. The true value for nitrogen in atropine is 4.84%. The average value for the period was 4.92 ± 0.03%. This is a mean recovery of 101.7%.

14. **POLLUTION PREVENTION**

- 14.1. Pollution prevention encompasses any technique that reduces or eliminates the quantity of toxicity of waste at the point of generation. Numerous opportunities for pollution prevention exist in laboratory operation. The USEPA has established a preferred hierarchy of environmental management techniques that places pollution as the management option of first choice. Whenever feasible, laboratory

personnel should use pollution prevention techniques to address their waste generation. When wastes cannot be feasibly reduced at the source, the agency recommends recycling as the next best option.

- 14.2. For information about pollution prevention that may be applicable to laboratories and research institutions, consult “Less is Better: Laboratory Chemical Management for Waste Reduction”, available from the American Chemical Society, Department of Government Relations and Science Policy, 1155 16th Street N. W., Washington, D.C. 20036.

15. WASTE MANAGEMENT

- 15.1. The reagents used in this procedure are minimal and are not hazardous with the exception of the Ascarite and magnesium perchlorate. Due to the small quantity of Ascarite and magnesium perchlorate used, the spent reagent can be flushed down the drain with running water.
- 15.2. For further information on waste management consult The Waste Management Manual for Laboratory Personnel, available from the American Chemical Society.

16. REFERENCES

- 16.1. U.S. Environmental Protection Agency, 1997. Methods for the Determination of Chemical Substances in Marine and Estuarine Environmental Samples. Method 440.0. U.S. Environmental Protection Agency. Washington, D.C.
- 16.2. Holme, N.A. and A.D. McIntyre (eds.). 1971. Methods for the Study of Marine Benthos. International Biome Program. IBP Handbook #16. F.A. Davis Co., Philadelphia, PA.
- 16.3. Hurd, D.C. and D.W. Spencer (eds). 1991. Marine Particles: Analysis and Characterization. Geophysical Monograph: 63, American Geophysical Union, Washington, D.C. 472p.
- 16.4. Hirota, J. and J.P. Szyper. 1975. Separation of total particulate carbon into inorganic and organic components. *Limnol and Oceanogr.* 20:896-900.
- 16.5. Grasshoff, K., M. Ehrhardt and K. Kremling (eds). 1983. Methods of Seawater Analysis. Verlag Chemie.
- 16.6. Keefe, Carolyn W., The Contribution of Inorganic Compounds to the Particulate Carbon, Nitrogen and Phosphorus in Suspended Matter and Surface Sediments of the Chesapeake Bay, *Estuaries*, Vol. 17, No 1B, pp 122-130, March 1994.
- 16.7. 40 CFR, Part 136, Appendix B. Definition and Procedure for the Determination of the Method Detection Limit. Revision 1.11.
- 16.8. Zimmermann, C. F., Keefe, C. W., and Bashe, J. 1997. Method 440.0. Determination of Carbon and Nitrogen in Sediments and Particulates of Estuarine/Coastal Waters Using Elemental Analysis. USEPA

17. DETAILED PROCEDURE

- 17.1. Exeter 440 Operation

- 17.1.1. The following sequence should be followed when initially starting up the system or when restarting after a shutdown.
- 17.1.1.1. Make sure the power switches on the computer and on the CEC- 490 (Interface) are off.
 - 17.1.1.2. Remove the 440 cover from instrument.
 - 17.1.1.3. Check that the helium regulator is set at 18 psig and oxygen at 20 psig and open the in-line gas valves.
 - 17.1.1.4. If restarting, check that the combustion and reduction tubes, scrubber and traps are not exhausted.
 - 17.1.1.5. Turn the selector switch to SYSTEM. Turn on the CEC-490 and the computer. The monitor will now display the Menu. If this is a cold re-start, set combustion and reduction furnace temperature controls to values previously established. Wait until the reduction furnace has reached operating temperature. **DO-NOT PUSH DETECTOR RESET BUTTON AT THIS TIME!**
 - 17.1.1.6. With the combustion to reduction tube end connector removed, go to “Tube Replacement” in the Service Menu, then follow the directions under “Combustion Tube Replacement” to purge the helium and oxygen regulators twice. This will also serve the purpose of conditioning the reduction and combustion tubes. Then go to Main Menu and install the end connectors.
 - 17.1.1.7. After allowing the 440 oven to reach operating temperature (about one hour) go to the Service Menu and select Calibrate CEC-490. Calibrate all and follow instructions.
 - 17.1.1.8. Run 2 to 3 blank runs to establish a fill time of about 20 to 40 seconds. If the fill time has been exceeded, increase the helium pressure by ½ psig, and repeat running until fill time is achieved. If the system still aborts after the helium pressure has been increased to 22 psig, go through the leak test mode.
 - 17.1.1.9. After the first complete run, push DET RESET. High concentrations of air or oxygen in the analytical system will damage the filaments in the detectors if power is applied. To protect the detectors, a detector safety circuit is provided which shuts off power when the helium carrier gas becomes contaminated with air or oxygen at levels generating an imbalance of about 450 uv or higher. The safety circuit will activate should leaks develop or when the helium supply is depleted. The safety circuit monitors the gross imbalance between the two sides of the nitrogen bridge. If air or oxygen is present on both sides of the bridge, the safety circuit may not activate and damage to the detectors may occur.

Make certain that helium gas is flowing and that the instrument is purged before pressing the DETECTOR RESET button.

The safety circuit is also activated when accidental or deliberate power interruption occurs. If power has been interrupted for more than 5 minutes, do not push DETECTOR RESET until the system has been run as if to run a blank. Do not hold the DETECTOR RESET button in or more than one second. If the light stays on when the button is released, further running is necessary before pushing the button again. Go through one blank run before turning on the detector.

- 17.1.1.10. After the last run go to the Service Menu and monitor the bridge readings. Adjust the “zero” reading to approximately 2500 μv by turning the respective potentiometers on the Bridge Balance Card located in the left rear corner of the “Motherboard”. Typically the bridges should be set well above negative or zero to approximately + 2500 μv . This is after the instrument has stabilized. Stability is based on furnace and oven temperatures being steady for a period of not less than 1 hour.
- 17.1.1.11. Check the furnace and oven temperatures. If these have reached operating levels, let the instrument go through another three sets of runs in order to purge the system and condition the reagents. This can be done through the CHN Run Mode (Run Menu).
- 17.1.1.12. Turn off the B-valve using the Parameters mode in the Customize pull-down menu. Continue running helium blanks until the base line (zero reading) is steady and/or until the blank for nitrogen and carbon is less than 200 μv , and for hydrogen less than 1500 μv .
- 17.1.1.13. Turn ON the B-valve and run oxygen blanks until consecutive runs agree within 10 μv for nitrogen and carbon, and 50 μv for hydrogen.
- 17.1.1.14. Go to the Service pull down Menu and calibrate all of the CEC-490 again.
- 17.1.1.15. The instrument is now ready for system calibration with known standards.
- 17.1.2. Standby Mode - To reduce helium consumption and minimize wear on the terminal screen, the overnight or short term standby mode is used.
 - 17.1.2.1. Select the overnight standby mode (in the Run pull-down menu).
 - 17.1.1.1. Return to normal operation.
 - 17.1.1.1.1. Select Stop Overnight Standby in the Run pull-down menu

- 17.1.2. Powering Down - It is preferable for the system to remain powered up at all times since this will extend the life time of the glassware, reagents, and electronics. However, helium and power will be consumed during this standby and it might be necessary to power down the 440 instrument. To assure minimum disruption for a future start up after a power down, proceed as follows:
 - 17.1.2.1. Turn the furnace temperature controllers to zero.
 - 17.1.2.2. Allow several hours for the furnace temperatures to drop below 100°C.
 - 17.1.2.3. Turn off the power to the instrument as well as gas valves between the instrument and the regulators.
 - 17.1.2.4. Turn off the gas on the cylinder.

- 17.2. 440 Software Summary
 - 17.2.1. Run Pull-Down Menu
 - 17.2.1.1. Carbon, Hydrogen, Nitrogen Run
 - 17.2.1.2. Oxygen
 - 17.2.1.3. Sulfur
 - 17.2.1.4. Overnight Standby (save carrier gas)
 - 17.2.1.5. Change Blanks and Ks
 - 17.2.1.6. Balance Interface Weight Entry
 - 17.2.2. Service Pull-Down Menu
 - 17.2.2.1. Datalog Signals
 - 17.2.2.2. Leak Test
 - 17.2.2.3. Profiles
 - 17.2.2.4. Tube Replacement (Includes packing and installing)
 - 17.2.2.5. Valve Rebuild
 - 17.2.2.6. Maintenance Schedule
 - 17.2.2.7. Maintenance Log
 - 17.2.2.8. Bridges
 - 17.2.2.9. Test Injector Drive
 - 17.2.2.10. Calibrate CEC-490
 - 17.2.2.11. Diagnostics
 - 17.2.2.12. Balance Interface Test
 - 17.2.3. Calculate Pull-Down Menu (Manipulating existing data)
 - 17.2.3.1. Recalculate data and statistics
 - 17.2.3.2. BTU/lb.
 - 17.2.3.3. Dry, Dry Ash Free
 - 17.2.3.4. H/C, N/C, C/H, C/N Ratio
 - 17.2.3.5. C/C, H/H, N/N, O/O, S/S Ratio
 - 17.2.3.6. Empirical Formula
 - 17.2.4. Customize Pull-Down Menu (Customizing software)
 - 17.2.4.1. Set parameters
 - 17.2.4.2. Users
 - 17.2.4.3. Edit Standards (names, weights, percents)
 - 17.2.4.4. Create Report Format

- 17.2.4.5.Change Infinite Run Counter
- 17.2.4.6.Set Automation Type
- 17.2.5. Help
- 17.3. Run Pull-Down Menu
 - 17.3.1. Select “Carbon, Hydrogen, Nitrogen Run”
 - 17.3.2. Select “Yes” for a new run
 - 17.3.3. Enter message for this run series
 - 17.3.3.1.Check “Enter the Ks and Blanks automatically”.
 - 17.3.3.2.Enter date followed by AM or PM as appropriate
 - 17.3.3.3.Press “Enter Data”
 - 17.3.4. Sample Entry Screen
 - 17.3.4.1.Enter Weight (μg)
 - 17.3.4.1.1. When entering the weight of the sample press [ENTER] to use the present weight or enter a new weight. If a weight of zero [0] is entered then the ID is assumed to be a blank. If a weight of 100 has been entered the results will be reported in micrograms (μg). When analyzing aqueous samples, enter the volume filtered/10 as the weight. The results will be reported in ug/l. When analyzing sediment samples or weighed QC samples, enter the weight in ug. The result will be reported in %.
 - 17.3.4.2.Enter Sample ID
 - 17.3.4.2.1. Enter the sample ID as either STD1, blank, or any other text. If STD is entered as the first three letters, then Ks will be calculated on the result report. If blank is entered, then blanks will be calculated. If a weight of 100 has been entered, the results will be reported in micrograms (μg). If a “weight” of volume filtered/10 has been entered, the results will be in ug/l. If a weight of ug has been entered, the result will be reported in %.
 - 17.3.4.3.Worksheet

Position #	Sample ID	Weight or volume/10	Comment, Sample Date or Client
1	Capsule+sleeve		
2	Conditioner		
3	Capsule+sleeve		
4	Conditioner		
5	STD1		
6	STD1		
7	STD1		
8	Capsule+Filter		
9	FD1		
10	FD2		

Appendix VII

11			
12			
13			
14			
15			
16			
17			
18			
19			
20	FD1		
21	FD2		
22			
23			
24			
25			
26			
27			
28			
29			
30			
31			
32	LFB Atropine		
33			
34			
35			
36			
37			
38			
39			
40			
41			
42	FD1		
43	FD2		
44			
45			
46			
47			
48			
49			
50			
51			
52			
53	FD1		
54	FD2		
55			
56			
57			
58			
59			
60			
61			
62	Capsule+sleeve		
63	LFB Atropine		

64	Capsule+sleeve		

17.3.4.4. Press “Start Run”

17.3.4.5. Loading the Sample Wheel into the Injector Box

This mode opens the ADF and C valves allowing helium to enter the injection box and minimize air in this area while installing the sample wheel for the 64 sample automatic injector. The pressure will build up and eventually equilibrate to the helium tank pressure if the instrument is left in this mode for a long period of time. This is not recommended, therefore, do not delay carrying out the following steps:

- 17.3.4.5.1. Open the manual purge valve on the injector box (right side, behind the P valve) to relieve the internal pressure. **NOTE: The injector housing should not be opened while pressurized. Vent the housing with the manual purge valve prior to opening the lid.**
- 17.3.4.5.2. Loosen the 4 cover screws and lift the lid. Remove the empty wheel from the sample chamber.
- 17.3.4.5.3. Vacuum out, or blow out with canned air, any material that might be in the box from the previous run (Loose material from the previous batch can contaminate samples, blanks and standards).
- 17.3.4.5.4. Insert the loaded sample wheel with the locking pin in place. Tilt the wheel slightly, line up the scribe mark on the wheel with the ratchet in the housing, lower the wheel and make sure that it is properly seated. Place the locking pin in the center hold. Check that the o-ring of the cover is clean and well seated in the groove before closing the cover.
- 17.3.4.5.5. Close the cover, and tighten equally on all four screws. This should be performed in an alternating sequence to achieve a uniform seal. Never over-tighten or use any tools on the screws.
- 17.3.4.5.6. Open and remove any spent capsules in the capsule receiver. Re-grease the gasket and re-install cover.
- 17.3.4.5.7. Close the purge valve, let pressure build up for about 30 seconds. Re-open the purge valve for about 5 seconds and then close again.
- 17.3.4.5.8. Select “OK” to continue operation.

17.3.4.6. The Sample Run

17.3.4.6.1. The sample is automatically injected into the combustion tube at the appropriate time. Upon completion of the fill time the ladle is retracted and allowed to cool. At the end of the run the results are printed and the soft key commands are followed if any has been selected. The screen returns to sample entry.

17.3.4.7. Run Display and Commands

Once the run begins, the screen displays the following information:

17.3.4.7.1. Run number, Sample Weight and ID., the operating K and B values, the preset combustion and purge times, valve status, and the elapsed time in minutes:seconds.

17.3.4.7.2. Temperatures and Pressure are also displayed near the bottom of the screen. These numbers may not be updated all of the time as time critical sections of a run occur. Run counters for the various tubes are displayed above the valve status diagram. The run counters will change from blue to red when they approach 10% within the thresholds set by the user.

17.3.4.7.3. During the run the analyst has various options available through the buttons at the top of the screen (accessed via simply selecting one). If a key is actuated, the button changes from grey to white. The buttons are for the following functions:

- a. **Ks & Bs** - To access the Ks and Bs table at the end of the current run. This allows the operator to change the operating values.
- b. **PARAMETERS** - Goes to parameters table at the end of the current run.
- c. **LEAK TEST** - The leak test program is activated at the end of the run cycle.
- d. **STANDBY** - At the end of the run cycle the instrument will go into overnight standby.
- e. **DATALOG** -At the end of the run cycle a datalog is printed every half hour. A, D, and F valves are turned on, as in the overnight standby mode.
- f. **SSI** - An HA function to activate the SSI (single sample inject) program after

the completion of the current run. The HA program will automatically resume after the SSI run (unless SSI is pressed again).

- g. **MENU NEXT** - Goes to the Analytical Menu at the end of the current run. The data will be stored on the data disc at that point.
- h. **STOP** - Aborts the current operation and goes to the Analytical Menu. This is typically only used during emergency operations. If you exit an HA run cycle prematurely and you wish to start over or resume the HA run with the sample IDs and weights already in memory, then DO NOT exit the Analytical Menu. If you exit or reboot the Analytical Menu then the IDs and weights will be erased.
- i. **NONE** – Nothing at end of run or run cycle.

17.4. Tube Replacement

17.4.1. This mode is used when one or more of the reagent tubes in the 440 need to be changed, as indicated by the maintenance schedule, poor analytical results or in the case of a cold restart.

17.4.2. Go to the Service Pull-down Menu. Select “Tube Replacement.” “Select CHN Analysis.” Another menu will be displayed that will contain options for tube packing information or for replacement of any tubes used for that analysis. If a new gas cylinder or regulator is to be replaced, select the appropriate tank changing from the menu.

17.4.2.1. Tube packing. By selecting the tube of interest the appropriate tube packing information is graphically displayed. In the individual tube replacement options, follow the step by step instruction shown on the screen. If the procedure is followed correctly and to its conclusion, the Maintenance Schedule Information for that tube will be reset. You can return to the Service Menu at almost any point by pressing “End.”

17.4.2.2. For the CHN Analysis there are instructions for:

- 17.4.2.2.1. Tube Packing Information
- 17.4.2.2.2. Helium Scrubber Replacement
- 17.4.2.2.3. Oxygen Scrubber Replacement
- 17.4.2.2.4. Carbon Dioxide Trap Replacement
- 17.4.2.2.5. Water Trap Replacement
- 17.4.2.2.6. Combustion Tube Replacement
- 17.4.2.2.7. Reduction Tube Replacement

17.4.2.2.8. Combustion & Reduction Tubes Replacement at the same time

17.4.3. Combustion Tube

- 17.4.3.1. Hold the tube vertically with the short end from the indentation up. Roll up a piece of platinum gauze so that it will fit snugly into the combustion tube. Slide the gauze plug into the tube and up against the indentation.
- 17.4.3.2. Add a small plug of quartz wool. (Quartz wool may be muffled for one hour at 850 °C to remove any residual carbon).
- 17.4.3.3. Add 1½" of silver tungstate/magnesium oxide on chromosorb. Gently tap the tube to prevent the reagent from channeling.
- 17.4.3.4. Add a small plug of quartz wool.
- 17.4.3.5. Add 2" of silver oxide/silver tungstate on Chromosorb tap the tube and add another small plug of quartz wool.
- 17.4.3.6. Slide a rolled-up piece of silver gauze into the tube and pack against the quartz wool. Make sure that there is no less than ½" of space between the end of the tube and the silver gauze since the silver gauze will conduct heat and damage the o-ring on the end connector.
- 17.4.3.7. The amount of each reagent used can be varied to suit the type of materials to be analyzed. For example, if predominantly fluoridated compounds are run proportionately more silver tungstate/magnesium oxide should be packed into the tube.
- 17.4.3.8. There is rarely such a thing as a "too tightly" packed combustion tube. Loosely packed combustion tubes can cause non-linearity.

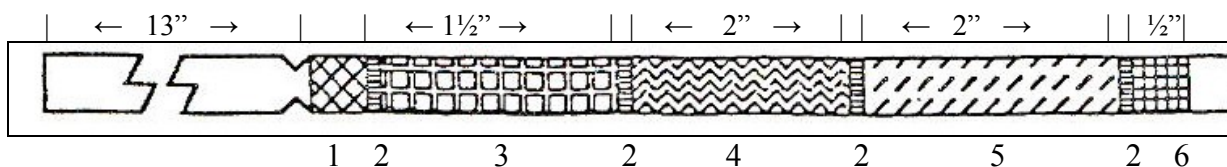

#1 - Platinum gauze



#2 - Quartz wool



#3 - Silver tungstate / Magnesium oxide on Chromosorb



#4 - Silver oxide / Silver tungstate on chromosorb



#5 - Silver vanadate on Chromosorb

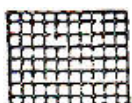

#6 - Silver gauze

17.4.3.9. Function of Combustion Tube Packing Material

17.4.3.9.1. Silver Vanadate on Chromosorb

Reacts with and removes chlorine, bromine, iodine and sulfur contained in the combustion gases. When absorbing sulfur, it changes color from yellow to dark brown when saturated. In absorbing halogens, exhaustion of the silver vanadate is indicated by color changes on the surface of the silver gauze at the end of the combustion tube. Each element forms a distinctively colored salt deposit – silver chloride is gray, silver bromide is brown, and silver iodide is purple. The gauze can be rejuvenated by heating in the upper, reducing portion of a Bunsen burner or muffling at 550°C for 90 minutes.

17.4.3.9.2. Silver Tungstate / Magnesium Oxide on chromosorb: Removes fluorine, phosphorus, and arsenic.

17.4.3.9.3. Silver Oxide / Silver Tungstate on chromosorb: Removes sulfur and halogens (except fluorine).

17.4.4. Reduction Tube

17.4.4.1. Pack about $\frac{3}{4}$ " of quartz wool into the bottom of the tube from the opposite end.

17.4.4.2. Fill the tube with copper wire while gently tapping to tightly settle the copper and avoid channeling.

17.4.4.3. Pack another plug of quartz wool into the tube against the copper.

17.4.4.4. Insert a rolled-up piece of silver gauze into each small diameter tube end.

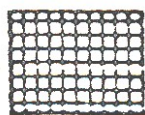
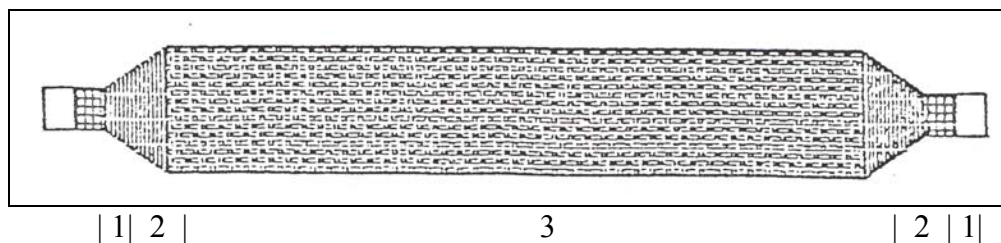

#1 - Silver gauze



#2 - Quartz wool



#3 - Copper wire

17.4.5. Carbon Dioxide Trap and Gas Scrubbers (3)

17.4.5.1. These three tubes are identically packed even though the Scrubbers are a larger diameter. Pack a $\frac{1}{4}$ " plug of quartz wool into one end of the tube.

17.4.5.2. Add $3\frac{1}{2}$ " Ascarite (Colorcarb) while gently tapping the tube.

17.4.5.3. Add $\frac{1}{4}$ " plug of quartz wool.

17.4.5.4. Add $1\frac{1}{2}$ " magnesium Perchlorate while gently tapping the tube.

17.4.5.5. Add $\frac{1}{4}$ " plug of quartz wool.

17.4.5.6. There should be about $\frac{1}{4}$ " of free space at each end of the tube.

17.4.5.7. Gas scrubbers should be loosely packed to allow for the high gas flows associated with the 440.

17.4.5.8. Note the orientation (in the instrument) of the helium and oxygen scrubbers versus the CO_2 scrubber. The orientation is reversed for the CO_2 scrubber.

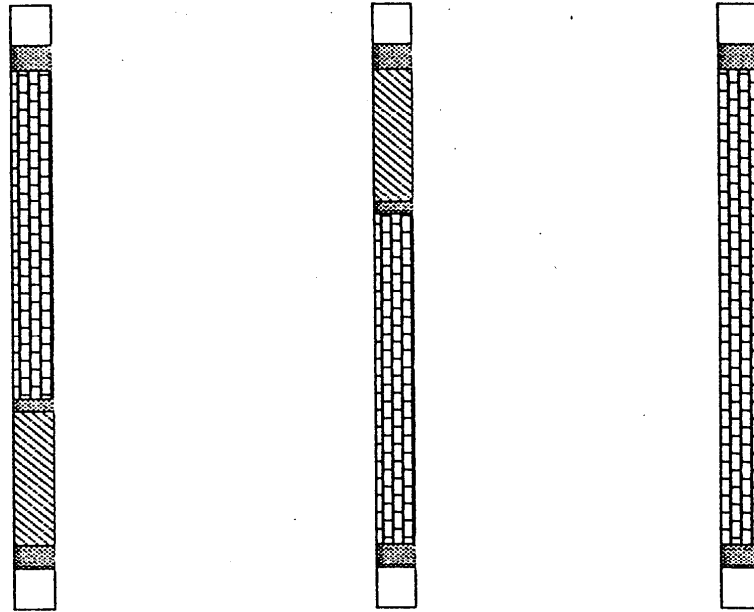

CHN Mode Helium
and Oxygen
Scrubbers

CHN Mode
CO2 Trap

CHN Mode
Water Trap

Ascarite 

Quartz Wool 

Magnesium Perchlorate 

NOTE the orientation of the CO2 trap
and the Gas Scrubbers !

- 17.4.6. Helium Scrubber Replacement
- 17.4.6.1. Close the inlet helium gas valve and back off the regulator valve. [HIT RETURN WHEN DONE]
 - 17.4.6.2. At this point the helium tank can also be replaced by removing the regulator and installing a new tank.
 - 17.4.6.3. To replace the helium scrubber carefully loosen the tube nut with a 440 tube nut wrench, loosen the wing nuts and lift the top assembly gently until the scrubber can be removed.
 - 17.4.6.4. Repack the scrubber as described in 18.6.5.
 - 17.4.6.5. Check the o-rings and effluent filters at this time. Make sure any quartz wool fibers, which could prevent a good seal, are removed from the outside of the scrubber before inserting.
 - 17.4.6.6. Replace the tube, bring the top assembly down and tighten the wing nuts. Tighten the lower nut **ONLY**. Very carefully open the in-line valve and increase the helium gas pressure to 5 psig. [HIT RETURN WHEN DONE]
 - 17.4.6.7. Wait one minute. A tone will sound. A clock on the screen counts down the time. When the tone sounds, the screen displays the message: "I'm finished purging the helium scrubber." [HIT RETURN TO ACKNOWLEDGE]
 - 17.4.6.8. Tighten the top nut on the helium scrubber. Increase the pressure to normal. [HIT RETURN WHEN DONE]
 - 17.4.6.9. Wait 5 minutes. This serves to purge the gas lines. Once the 5 minutes have passed, the Tube Replacement Menu for the chosen analysis mode will be displayed.
 - 17.4.6.10. The instrument should be conditioned after replacing the halogen scrubber by running two blanks before proceeding to a sample run.
 - 17.4.6.11. If the helium tank has been replaced, purge the regulator 5 times and run a helium blank profile to verify good gas.
- 17.4.7. Oxygen Scrubber Replacement
- 17.4.7.1. Close the inlet oxygen gas valve and back off the regulator valve. [HIT RETURN WHEN DONE]
 - 17.4.7.2. At this point the oxygen tank can also be replaced by removing the regulator and installing a new tank.
 - 17.4.7.3. To replace the oxygen scrubber carefully loosen the tube nut with a 440 tube nut wrench, loosen the wing nuts and lift the top assembly gently until the scrubber can be removed.
 - 17.4.7.4. Repack the scrubber as described in 18.6.5.
 - 17.4.7.5. Check the o-rings and effluent filters at this time. Make sure any quartz wool fibers, which could prevent a good seal, are removed from the outside of the scrubber before inserting.
 - 17.4.7.6. Replace the tube, bring the top assembly down and tighten the wing nuts. Tighten the lower nut **ONLY**. Very carefully

- open the in-line valve and increase the oxygen gas pressure to 5 psig. [HIT RETURN WHEN DONE].
- 17.4.7.7. Wait one minute. A tone will sound. A clock on the screen counts down the time. When the tone sounds, the screen displays the message “I’m finished purging the oxygen scrubber. [HIT RETURN TO ACKNOWLEDGE]
- 17.4.7.8. Tighten the top nut on the oxygen scrubber. Increase the pressure to normal. [HIT RETURN WHEN DONE]
- 17.4.7.9. The instrument should be conditioned after replacing the oxygen scrubber by running two blanks before proceeding to a sample run.
- 17.4.7.10. The procedure for replacing the oxygen scrubber is identical to that of the helium scrubber. The only difference is the omission of the 5 minute purge.
- 17.4.8. Carbon Dioxide Trap Replacement
- 17.4.8.1. Replace the carbon dioxide trap. Tighten the lower nut only. [HIT RETURN WHEN DONE]
- 17.4.8.2. Be sure to orient the trap correctly, with the Ascarite portion toward the top.
- 17.4.8.3. Check the o-rings and re-grease lightly, also check the effluent filters at this time.
- 17.4.8.4. Wait 1 minute. A tone will sound. A clock counts down the time on the screen and then displays “I’m finished purging the carbon dioxide trap”. [HIT RETURN TO ACKNOWLEDGE]
- 17.4.8.5. Tighten the top nut on the carbon dioxide trap. Increase the pressure to normal. [HIT RETURN WHEN DONE] (Ignore the instructions regarding pressure).
- 17.4.8.6. When completed, the Tube Replacement Menu for the CHN analysis mode will be displayed.
- 17.5. Important Factors for Proper 440 Operation
- 17.5.1. Pack the scrubber tubes loosely.
- 17.5.2. Vibrate or tap down the combustion tube packing chemicals while packing to assure a fairly tight tube. DO NOT over-tighten.
- 17.5.3. Oxygen pressure should be at ≈ 20 psig.
- 17.5.4. Helium pressure should be at ≈ 18 psig and the fill time (FT) for a run should be between 20 and 40 seconds.
- 17.5.5. When greasing o-rings or gaskets, it is recommended to use Krytox (R) by Dupont.
- 17.5.6. The furnace temperatures reach set temperature very quickly. Do not set the furnaces to anything but the temperature for analysis.
- 17.5.7. Never set the combustion temperature above 1100 °C.
- 17.5.8. Never set the reduction temperature above 900 °C.
- 17.5.9. All valves are “Normally Closed” type.

Spectrophotometric Determination of Chlorophyll α in waters and sediments of Fresh/Estuarine/Coastal Areas.

1. SCOPE and APPLICATION

- 1.1 This is an acetone extraction method to determine chlorophyll α in fresh and estuarine waters.
- 1.2 A Method Detection Limit (MDL) of 0.62 $\mu\text{g/L}$ active chl α and 0.74 $\mu\text{g/L}$ phaeophytin was determined using 3X the standard deviation of 7 replicates.
- 1.3 The quantitation limit for chl α is dependent upon sample volume.
- 1.4 This procedure should be used by analysts experienced in the theory and application of chlorophyll analysis. Three months experience with an experienced analyst, certified in the analysis using the spectrophotometer, is required.
- 1.5 This method can be used for all programs that require spectrophotometric analysis of chlorophyll α .
- 1.6 This procedure is based Standard Methods 10200H, 19th Edition.

2. SUMMARY

- 2.1 Chlorophyll α is extracted from the cells using a 90% solution of acetone. The samples are refrigerated in the dark from 2 to 24 hours (over night is preferable). After the appropriate time, the samples are centrifuged to separate the sample material from the extract. Because the waters of the Maryland portion of the Chesapeake Bay are relatively turbid, the sample extract is filtered through a 0.45 μm ptfе or nylon syringe filter and transferred into a clean tube, and centrifuged again for 30 minutes. The extract is analyzed on a spectrophotometer. To determine phaeophytin and active chl α , the extract is then acidified using 1N HCl, and reread. The concentrations are then calculated using the monochromatic equation. Uncorrected chlorophyll may be determined using the trichromatic equation.

3. DEFINITIONS

- 3.1 Absorbance – A measure of the amount of light at a specific wavelength absorbed by a liquid.
- 3.2 Acceptance Criteria – Specified limits placed on characteristics of an item, process, or service defined in a requirement document. (ASQC)
- 3.3 Accuracy – The degree of agreement between an observed value and an accepted reference value. Accuracy includes a combination of random error

- (precision) and systematic error (bias) components which are due to sampling and analytical operations; a data quality indicator. (QAMS)
- 3.4 Aliquot – A discrete, measured, representative portion of a sample taken for analysis. (EPA QAD Glossary)
 - 3.5 Analytical Range – The analytical range is dependent on the volume of water filtered and the volume of acetone used in the extraction.
 - 3.6 Batch – Environmental samples, which are prepared and /or analyzed together with the same process and personnel, using the same lot(s) of reagents. A **preparation batch** is composed of one to 20 environmental samples of the same matrix, meeting the above mentioned criteria and with a maximum time between the start of processing of the first and last sample in the batch to be 24 hours. An **analytical batch** is composed of prepared environmental samples (extracts, digestates, or concentrates) and/or those samples not requiring preparation, which are analyzed together as a group using the same calibration curve or factor. An analytical batch can include samples originating from various environmental matrices and can exceed 20 samples. (NELAC/EPA)
 - 3.7 Blank- A sample that has not been exposed to the analyzed sample stream in order to monitor contamination during sampling, transport, storage or analysis. The blank is subjected to the usual analytical and measurement process to establish a zero baseline or background value and is sometimes used to adjust or correct routine analytical results. (ASQC)
 - 3.8 Calibrate- To determine, by measurement or comparison with a standard, the correct value of each scale reading on a meter or other device, or the correct value for each setting of a control knob. The levels of the applied calibration standard should bracket the range of planned or expected sample measurements. (NELAC)
 - 3.9 Calibration – The set of operations which establish, under specified conditions, the relationship between values indicated by a measuring device. The levels of the applied calibration standard should bracket the range of planned or expected sample measurements. (NELAC)
 - 3.10 Calibration Curve – The graphical relationship between known values, such as concentrations, or a series of calibration standards and their analytical response. (NELAC)
 - 3.11 Calibration Method – A defined technical procedure for performing a calibration. (NELAC)
 - 3.12 Calibration Standard – A substance or reference material used to calibrate an instrument. (QAMS)
 - 3.12.1 Initial Calibration Standard (STD) – A series of standard solutions used to initially establish instrument calibration responses and develop calibration curves for individual target analytes.
 - 3.12.2 Initial Calibration Verification (ICV) – An individual standard, analyzed initially, prior to any sample analysis, which verifies acceptability of the calibration curve or previously established calibration curve.

- 3.12.3 Continuing Calibration Verification (CCV) – An individual standard which is analyzed after every 10-15 field sample analysis.
- 3.13 Certified Reference Material – A reference material one or more of whose property values are certified by a technically valid procedure, accompanied by or traceable to a certificate or other documentation which is issued by a certifying body. (ISO 17025)
- 3.14 Corrective Action – Action taken to eliminate the causes of an existing nonconformity, defect or other undesirable situation in order to prevent recurrence. (ISO 8402)
- 3.15 Deficiency – An unauthorized deviation from acceptable procedures or practices. (ASQC)
- 3.16 Demonstration of Capability – A procedure to establish the ability of the analyst to generate acceptable accuracy. (NELAC)
- 3.17 Detection Limit – The lowest concentration or amount of the target analyte that can be determined to be different from zero by a single measurement at a stated degree of confidence.
- 3.18 Duplicate Analysis – The analyses of measurements of the variable of interest performed identically on two sub samples (aliquots) of the same sample. The results from duplicate analyses are used to evaluate analytical or measurement precision but not the precision of sampling, preservation or storage internal to the laboratory. (EPA-QAD)
- 3.19 External Standard (ES) – A pure analyte (anacystis nidulans algae, or equivalent) that is measured in an experiment separate from the experiment used to measure the analyte(s) in the sample. The signal observed for a known quantity of the pure external standard is used to calibrate the instrument response for the corresponding analyte(s). The instrument response is used to calculate the concentrations of the analyte(s) in the unknown sample.
- 3.20 Field Duplicates (FD1 and FD2) – Two separate samples collected at the same time and place under identical circumstances and treated exactly the same throughout field and laboratory procedures. Analyses of FD1 and FD2 provide a measure of the precision associated with sample collection, preservation and storage, as well as with laboratory procedures.
- 3.21 Field Reagent Blank (FRB) – An aliquot of reagent water or other blank matrix that is placed in a sample container in the laboratory and treated as a sample in all respects, including shipment to the sampling site, exposure to the sampling site conditions, storage, preservation, and all analytical procedures. The purpose of the FRB is to determine if method analytes or other interferences are present in the field environment.
- 3.22 Holding time – The maximum time that samples may be held prior to analysis and still be considered valid. (40 CFR Part 136) The time elapsed from the time of sampling to the time of extraction or analysis, as appropriate.
- 3.23 Instrument Detection Limit (IDL) – The minimum quantity of analyte of the concentration equivalent which gives an analyte signal equal to three times the standard deviation of the background signal at the selected wavelength, mass, retention time absorbance line, etc.

- 3.24 Laboratory Duplicates (LD1 and LD2) – Two aliquots of the same sample taken in the laboratory and analyzed separately with identical procedures. Analyses of LD1 and LD2 indicate precision associated with laboratory procedures, but not with sample collection, preservation, or storage procedures.
- 3.25 Laboratory Reagent Blank (LRB) – A matrix blank (i.e., 90% acetone) that is treated exactly as a sample including exposure to all glassware, equipment, solvents, and reagents that are used with other samples. The LRB is used to determine if method analytes or other interferences are present in the laboratory environment, the reagents, or the instrument.
- 3.26 Laboratory Control Sample (LCS) – A sample matrix, free from the analytes of interest, spiked with verified known amounts of analytes from a source independent of the calibration standard or a material containing known and verified amounts of analytes. The LCS is generally used to establish intra-laboratory or analyst-specific precision and bias or to assess the performance of all or a portion of the measurement system. (NELAC)
- 3.27 Limit of Detection (LOD) – The lowest concentration level that can be determined by a single analysis and with a defined level of confidence to be statistically different from a blank. (ACS)
- 3.28 Limit of Quantitation (LOQ) – The minimum levels, concentrations, or quantities of a target variable (target analyte) that can be reported with a specified degree of confidence. The LOQ is set at 3 to 10 times the LOD, depending on the degree of confidence desired.
- 3.29 Linear Dynamic Range (LDR) – The absolute quantity over which the instrument response to an analyte is linear. This specification is also referred to as the Linear Calibration Range (LCR).
- 3.30 Material Safety Data Sheets (MSDS) – Written information provided by vendors concerning a chemical's toxicity, health hazards, physical properties, fire, and reactivity data including storage, spill, and handling precautions.
- 3.31 May – Denotes permitted action, but not required action. (NELAC)
- 3.32 Method Detection Limit (MDL) – The minimum concentration of an analyte that can be identified, measured, and reported with 98% confidence that the analyte concentration is greater than zero.
- 3.33 Monochromatic equation – Also known as Lorenzen's modified monochromatic equation, it requires the absorbance values of 664 and 665 nm before and after an acidification step of 90 seconds to calculate the amount of chlorophyll *a* and phaeophytin in the sample. The chlorophyll *a* is reported as corrected for phaeophytin. Chlorophyll *b* and *c* cannot be calculated using this equation.
- 3.34 Must – Denotes a requirement that must be met. (Random House College Dictionary)
- 3.35 Path Length – The path length is the width of the cuvette cell (length between optical non-frosted sides). For this method, 5 and 1 cm path length cuvettes are used.
- 3.36 Precision – The degree to which a set of observations or measurements of the same property, obtained under similar conditions, conform to themselves; a data

- quality indicator. Precision is usually expressed as standard deviation, variance or range, in either absolute or relative terms. (NELAC)
- 3.37 Preservation – Refrigeration, freezing, and/or reagents added at the time of sample collection (or later) to maintain the chemical and or biological integrity of the sample.
 - 3.38 Quality Control Sample (QCS) – A sample of analytes of known and certified concentrations. The QCS is obtained from a source external to the laboratory and different from the source of calibration standards. It is used to check laboratory performance with externally prepared test materials.
 - 3.39 Run – One sample analysis from start to finish, including printout.
 - 3.40 Run Cycle – Typically a day of operation – the entire analytical sequence of runs from the first run to the last run and including the transfer of run cycle data to the disc.
 - 3.41 Sample Volume – Volume of water filtered.
 - 3.42 Sensitivity – The capability of a test method or instrument to discriminate between measurement responses representing different levels (concentrations) of a variable of interest.
 - 3.43 Shall – Denotes a requirement that is mandatory whenever the criterion for conformance with the specification requires that there be no deviation. (ANSI)
 - 3.44 Should – Denotes a guideline or recommendation whenever noncompliance with the specification is permissible. (ANSI)
 - 3.45 Standard Reference Material (SRM) – Material which has been certified for specific analytes by a variety of analytical techniques and/or by numerous laboratories using similar analytical techniques. These may consist of pure chemicals, buffers, or compositional standards. The materials are used as an indication of the accuracy of a specific analytical technique.
 - 3.46 Trichromatic equation – Also known as Jeffrey and Humphrey's Trichromatic Equations, they require absorbance values at 664, 647, and 630 nm to calculate the amount of uncorrected chlorophyll α in a sample. Chlorophyll b and c pigments can also be determined. No acidification is required and phaeophytin cannot be calculated from this equation.

4. INTERFERENCES

- 4.1 Light and heat cause the chlorophyll molecule to break down. Therefore, the samples should be kept cold in the dark and care should be taken when grinding the samples so as not to overheat the sample.
- 4.2 Any compound that absorbs light between 630 and 665 nm may interfere with chlorophyll measurement. The absorbance measurement at 750 nm is subtracted from the sample's other measured absorbances (665, 664, 647, and 630 nm) to account for the turbidity of the clarified sample. If the absorbance at 750 nm is above 0.007 absorbance units (AU), the sample may be filtered one more time.
- 4.3 The spectral overlap of chlorophyll α , b , and c and phaeophytin can cause over or under-estimation of chlorophyll and/or phaeophytin. The amount of

chlorophyll *b* and *c* in a sample is dependent on the taxonomic composition of the phytoplankton it contains. In the trichromatic equation, chlorophyll α may be overestimated in the presence of phaeophytin. In the monochromatic equation, chlorophyll α may be slightly overestimated in the presence of chlorophyll *b* and phaeophytin may be overestimated in the presence of carotenoids.

5. SAFETY

- 5.1 Safety precautions must be taken when handling reagents, samples and equipment in the laboratory. Protective clothing including lab coats, safety glasses and enclosed shoes should be worn. In certain situations, it will be necessary to also use gloves and/or a face shield. If solutions come in contact with eyes, flush with water continuously for 15 minutes. If solutions come in contact with skin, wash thoroughly with soap and water. Contact Solomons Rescue Squad (911) if emergency treatment is needed and also inform the CBL Business Manager of the incident. Contact the CBL Business Manager if additional treatment is required.
- 5.2 The toxicity or carcinogenicity of each reagent used in this procedure may not have been fully established. Each chemical should be regarded as a potential health hazard and exposure should be as low as reasonably achievable. Cautions are included for known hazardous materials and procedures.
- 5.3 Do not wear jewelry when troubleshooting electrical components. Even low voltage points are dangerous and can injure if allowed to short circuit.
- 5.4 The following hazard classifications are listed for the chemicals used in this procedure. Detailed information is provided on Material Safety Data Sheets (MSDS).

Chemical	Health	Flammability	Reactivity	Contact	Storage
Hydrochloric Acid	3	0	2	4	White
Acetone	2	3	0	3	Red

On a scale of 0 to 4 the substance is rated on four hazard categories: health, flammability, reactivity, and contact. (0 is non-hazardous and 4 is extremely hazardous)

STORAGE

Red – Flammability Hazard: Store in a flammable liquid storage area.

Blue – Health Hazard: Store in a secure poison area.

Yellow – Reactivity Hazard: Keep separate from flammable and combustible materials.

White – Contact Hazard: Store in a corrosion-proof area.

Green – Use general chemical storage (On older labels, this category was orange).

Striped – Incompatible materials of the same color class have striped labels. These products should not be stored adjacent to substances with the same color label. Proper storage must be individually determined.

1. EQUIPMENT AND SUPPLIES

- 6.1 A scanning spectrophotometer capable of measuring wavelengths within the visible range. This laboratory uses Shimadzu UV2401PC and UV2450PC spectrophotometers.
- 6.2 Freezer, capable of maintaining $-20^{\circ} \pm 5^{\circ}$ C.
- 6.3 Lab ware – All reusable lab ware (glass, Teflon, plastic, etc) should be sufficiently clean for the task objectives.
- 6.4 A centrifuge.
- 6.5 A Teflon pestle for grinding, either by hand or power, and/or a sonicator.
- 6.6 5-cm path length and 1-cm path length cuvettes of either special optical glass or quartz.

2. REAGENTS AND STANDARDS

- 7.1 Purity of Water – Unless otherwise indicated, references to water shall be understood to mean reagent water conforming to ASTM Specification D 1193, Type I. Freshly prepared water should be used for making the standards intended for calibration. The detection limits of this method will be limited by the purity of the water and reagents used to make the standards.
- 7.2 Purity of Reagents – Reagent grade chemicals shall be used in all tests. Unless otherwise indicated, it is intended that all reagents shall conform to specifications of the Committee on Analytical Reagents of the American Chemical Society, where such specifications are available. Other grades may be used, provided it is first ascertained that the reagent is of sufficiently high purity to permit its use without compromising the accuracy of the determination.
- 7.3 Acetone ($\text{H}_2\text{C}=\text{O}=\text{CH}_2$), 90% v/v

Acetone, reagent grade	900 ml
De-ionized water	100 ml

Using a graduated cylinder, add 100 ml de-ionized water to 900 ml acetone.
- 7.4 Hydrochloric Acid, 1N –

Hydrochloric acid (HCl), concentrated,	8.6 ml
De-ionized water, q.s.	100 ml

In a 100 ml volumetric flask, add 8.6 ml of concentrated hydrochloric acid to ~60 ml of de-ionized water. Dilute to 100 ml with de-ionized water.

- 7.5 Blanks – A reagent blank of 90% acetone is used.
- 7.6 Standards – Standards used are one of the following:
 - 7.6.1 Chlorophyll α from *Anacystis nidulans* algae, PN C6144-1MG, ordered from Sigma. If chlorophyll from algae is not available, chlorophyll α from spinach may be substituted.

7.7 Quality Control Sample (QCS) – For this procedure, the QCS can be any certified sample which is obtained from an external source. If a certified sample is not available, then use the standard material.

8 SAMPLE COLLECTION, PRESERVATION, AND STORAGE

- 8.1 Water collected for chl α should be filtered through a Whatman GF/F glass fiber filter (nominal pore size 0.7 μm), or equivalent.
- 8.2 Water collected for chl α should be filtered as soon as possible. If immediate filtration is not possible, the water samples should be kept on ice in the dark and filtered within 24 hours.
- 8.3 The sample is kept frozen at -20°C or lower. Filter pads may be folded in half and stored in folded aluminum foil pouches.
- 8.4 Frozen chl α filters should be extracted within 4 weeks. Once the sample is extracted, the clarified extract may be stored at -20°C for up to 1 year, preferably analyzed within 28 days.

9 QUALITY CONTROL

- 9.1 The laboratory is required to operate a formal quality control (QC) program. The minimum requirements of this program consist of an initial demonstration of laboratory capability and the continued analysis of laboratory instrument blanks and calibration standard material, analyzed as samples, as a continuing check on performance. The laboratory is required to maintain performance records that define the quality of data generated.
- 9.2 Initial Demonstration of Capability
 - 9.2.1 The initial demonstration of capability (DOC) – is used to characterize instrument performance (MDLs) and laboratory performance (analysis of QC samples) prior to the analyses conducted by this procedure.
 - 9.2.2 Quality Control Sample (QCS/SRM) – When using this procedure, a quality control sample is required to be analyzed at the beginning and end of the run, to verify data quality and acceptable instrument performance. If the determined concentrations are not within $\pm 10\%$ of the certified values, performance of the determinative step of the method is unacceptable. The source of the problem must be identified and corrected before either proceeding with the initial determination of MDLs or continuing with analyses.
 - 9.2.3 Method Detection Limits (MDLs) – MDLs should be established for chl α using a low level ambient water sample. To determine the MDL values, analyze seven replicate aliquots of water. Perform all calculations defined in the procedure (Section 11) and report the concentration values in the appropriate units. Calculate the MDL as follows:

$$\text{MDL} = S \times 3$$

Where, S = Standard Deviation of the replicate analyses.

9.2.4 MDLs should be determined yearly.

9.3 Assessing Laboratory Performance

9.3.1 Laboratory Reagent Blank (LRB) – The laboratory reagent blank is analyzed at the beginning of each sample run, after every tenth sample, and at the end of the run. The LRB consists of 90% acetone treated the same as the samples. LRB data are used to assess contamination from the laboratory environment.

9.4 Data Assessment and Acceptance Criteria for Quality Control Measures

9.4.1 The Acceptance Criteria for chl_a is 0.9990. If the r² is less than acceptable, the standards must be made again.

9.5 Corrective Actions for Out of Control Data

9.5.1 The sample is first analyzed using the 5 cm path length cuvette. If the reading is above 1.0 absorbance units, the sample should be reread using the 1 cm cuvette.

9.5.2 If the absorbance of the LRB shows an upward trend, AUTOZERO and re-BASELINE, then reread that LRB.

10 CALIBRATION AND STANDARDIZATION

10.1 Calibration – Quarterly calibrations with standards of known concentration are performed.

10.2 In using *Anacystis nidulans* algae, the concentration must be determined by spectrophotometer.

11 PROCEDURE

11.1 Sample Preparation – water column

11.1.1 Filter a known volume of water through a Whatman GF/F filter pad (nominal pore size 0.7 μm). Good color is needed on the pad. Do not rinse the pad.

11.1.2 Fold pad in half, sample inside, wrap in aluminum foil, label and freeze for analysis within 4 weeks.

11.1.3 Before analysis, briefly thaw pads, and then place in a 15 ml centrifuge tube. Add 10 ml of 90% acetone. Work under subdued lighting.

- 11.1.4 Write all information in the lab bench sheet.
 - 11.1.5 Using a Teflon pestle, grind the filter against the side of the tube until the filter is well ground. If hand grinding, 10-15 seconds is all that is necessary. Power grinding requires vigilance, because excess heat will degrade the chlorophyll. Allow the sample to extract for 2 - 24 hours in the dark under refrigeration. Overnight is recommended.
 - 11.1.6 Remove tubes from refrigerator.
 - 11.1.7 Shake tubes, and then centrifuge at ~2400 rpm for 30 minutes. Filter and transfer the extract to a second numbered centrifuge tube. The extract is filtered through 0.45 um ptfе or nylon syringe filters. Centrifuge the samples again for 20 minutes at ~ 2400 rpm.
- 11.2 Pollution Prevention and Waste Management
- 11.2.1 This method generates hazardous waste.
 - 11.2.2 Acetone waste is stored in 4 liter jugs in the cabinet under the hood and transferred to the hazardous waste area of the Storage Facility on campus.
 - 11.2.3 Do not pour acetone down the sink.
 - 11.2.4 Decant the waste acetone into the waste jugs, and then allow the remaining ground filter pad or sediment to dry in the hood.
 - 11.2.5 The dried waste may then be put in the trash.
- 11.3 Using the Shimadzu UVProbe software:
- 11.3.1 Turn on the spectrophotometer (either the UV2401 or the UV2450) and the computer. Open the UVProbe software. Select photometric mode and connect to the instrument to turn on the lamps. Allow the instrument to run the lamp check and click OK. Allow the lamps to warm up for a minimum of 45 minutes before beginning sample analysis.
 - 11.3.2 Using the 5 cm path length cuvettes, fill both the reference and sample cuvettes with 90% acetone. Wipe the windows of the cuvettes carefully with lens paper to dry. Click on AUTOZERO, then run a BASELINE. When the baseline is complete, label the first line of the sample table as blk1. Click on READ UNK (unknown) or press F9 to begin scanning. All wavelengths should be very close to zero. If not, AUTOZERO again, and rerun the BASELINE. Run blk2 if needed.
 - 11.3.3 The reference cuvette is filled with 90% acetone and is left in place. Periodically check the liquid level, adding more 90% acetone as needed.
 - 11.3.4 Begin analyzing samples. Enter the sample name in the sample table twice, once with a "b" designation for before acid, and again with an "a" designation for after acid.
 - 11.3.5 Dispense sample into the sample cuvette. Wipe the windows of the cuvette carefully with lens paper and place in the cell holder.

- 11.3.6 Check the absorbance at 750 nm. If it is at 0.007 or below, press F9 to start the scan. If it is above 0.007, the sample may be filtered one more time through a 0.45 um ptfe syringe filter. If the 750 nm absorbance is still not below 0.007, proceed with the scan. It may be necessary to recheck the zero if several samples in a row start above 0.007 at the 750 nm reading.
- 11.3.7 After the first scan is read, add enough 1N HCl to the sample to achieve a concentration of 0.003 N HCl within the sample. We use 1 drop in the 3-ml ultra micro cuvettes and 3 drops in the 7-ml semi-micro cuvettes. Gently stir the sample for 30 seconds and wait another 30 seconds before starting the scan. A total of 90 seconds is needed to complete the reaction before reading.
- 11.3.8 Rinse the sample cuvette with acetone after each sample. Then rinse with a small amount of sample before filling.
- 11.3.9 Repeat steps 11.3.4 through 11.3.6 for all samples, adding a blank after every 10 samples.
- 11.3.10 Run a blank at the end
- 11.3.11 Save the file. Right click on Properties.
- 11.3.12 Hide columns TYPE, EX, and CONC. Print file.
- 11.3.13 Save the file again as a text file to be imported into a spreadsheet for calculation.

12. Calculations:

Chlorophyll corrected for phaeophytin (ug/L or mg/m³):

$$\text{Chlorophyll } \alpha \text{ corrected (ug/L)} = \frac{26.7(664_B - 665_A) \times V_1}{V_2 \times L}$$

Phaeophytin (ug/L or mg/m³):

$$\text{Phaeophytin } \alpha \text{ (ug/L)} = \frac{26.7 [1.7(665_A) - 664_B] \times V_1}{V_2 \times L}$$

Uncorrected chlorophyll (ug/L or mg/m³):

$$\text{Chlorophyll } \alpha \text{ uncorrected (ug/L)} = \frac{[11.85(664_B) - 1.54(647_B) - 0.8(630_B)] \times V_1}{V_2 \times L}$$

Chlorophyll/Phaeophytin ratio:

Absorption peak ratio: $664_B/665_A$

Where: 664_B = Subtract 750 nm value (turbidity correction) from absorbance at 664 nm before acidification.

665_A = turbidity corrected absorbance at 665 nm after acidification.

647_B = turbidity corrected absorbance at 647 nm before acidification.

630_B = turbidity corrected absorbance at 630 nm before acidification.

V_1 = volume of extract (mL)

V_2 = volume of sample filtered (L)
L = path length (cm)

13 References:

- 13.1 APHA, Standard Methods for the Examination of Water and Wastewater, Method #10200H, 19th Edition.
- 13.2 EPA Method 446.0.

Determination of Silicate from Fresh, Estuarine, and Coastal Waters Using the Molybdosilicate Method on the AquaKem 250 Analyzer

1. SCOPE and APPLICATION

- 1.1. The reaction is based on the reduction of silicomolybdate in acidic solution to “molybdenum blue” by ascorbic acid. Oxalic acid is added to minimize interference from phosphates. The method is used to analyze all ranges of salinity.
- 1.2. A Method Detection Limit (MDL) of 0.01 mg Si/L was determined using 3X the standard deviation of 7 replicates.
- 1.3. The Quantitation Limit for Si was set at 0.03 mg Si/L, or ten times the standard deviation of the MDL calculation.
- 1.4. The method is suitable for Si concentrations 0.03 to 10.5 mg Si/L.
- 1.5. This procedure should be used by analysts experienced in the theory and application of aqueous inorganic analysis. Three months experience with an experienced analyst, certified in the analysis of silicate in aqueous samples is required.
- 1.6. This method can be used for all programs that require analysis of dissolved silicate.
- 1.7. This procedure conforms to EPA Method 366.0. (1997).

2. SUMMARY

- 2.1. Filtered samples are mixed with oxalic acid, ammonium molybdate, and sulfuric acid. The resulting silicomolybdate is reduced to molybdenum blue by the addition of ascorbic acid. The oxalic acid is added to destroy molybdophosphoric acid formed from phosphorus in the sample.

3. DEFINITIONS

- 3.1. **Acceptance Criteria** - Specified limits placed on characteristics of an item, process, or service defined in a requirement document. (ASQC)
- 3.2. **Accuracy** - The degree of agreement between an observed value and an accepted reference value. Accuracy includes a combination of random error (precision) and systematic error (bias) components which are due to sampling and analytical operations; a data quality indicator. (QAMS)
- 3.3. **Aliquot** - A discrete, measured, representative portion of a sample taken for analysis. (EPA QAD Glossary)
- 3.4. **Analytical Range** – the analytical range is 0.03 to 10.5 mg Si/L. The overall analytical range is comprised of two distinct yet overlapping concentration ranges. A separate calibration is performed for each range. These ranges include 0.2 to 2.1 mg Si/L, and 1.05 to 10.5 mg Si/L. Two ranges are utilized so that samples can be analyzed on the most appropriate scale possible.
- 3.5. **Batch** – Environmental samples, which are prepared and /or analyzed together with the same process and personnel, using the same lot(s) of reagents. A **preparation batch** is composed of one to 200 environmental samples of the same matrix, meeting

the above mentioned criteria and with a maximum time between the start of processing of the first and last sample in the batch to be 8 hours. An **analytical batch** is composed of prepared environmental samples (extracts, digestates, concentrates) and/or those samples not requiring preparation, which are analyzed together as a group using the same calibration curve or factor. An analytical batch can include samples originating from various environmental matrices and can exceed 20 samples. (NELAC/EPA)

- 3.6. **Blank** - A sample that has not been exposed to the analyzed sample stream in order to monitor contamination during sampling, transport, storage or analysis. The blank is subjected to the usual analytical and measurement process to establish a zero baseline or background value and is sometimes used to adjust or correct routine analytical results. (ASQC)
- 3.7. **Calibrate** - To determine, by measurement or comparison with a standard, the correct value of each scale reading on a meter or other device, or the correct value for each setting of a control knob. The levels of the applied calibration standard should bracket the range of planned or expected sample measurements. (NELAC)
- 3.8. **Calibration** - The set of operations which establish, under specified conditions, the relationship between values indicated by a measuring device. The levels of the applied calibration standard should bracket the range of planned or expected sample measurements. (NELAC)
- 3.9. **Calibration Blank** – A volume of reagent water fortified with the same matrix as the calibration standards, without analyte added.
- 3.10. **Calibration Curve** – The graphical relationship between known values, such as concentrations, or a series of calibration standards and their analytical response. (NELAC)
- 3.11. **Calibration Method** - A defined technical procedure for performing a calibration. (NELAC)
- 3.12. **Calibration Standard** - A substance or reference material used to calibrate an instrument. (QAMS)
 - 3.12.1. **Initial Calibration Standards (STD)** - A series of standard solutions used to initially establish instrument calibration responses and develop calibration curves for individual target analytes.
 - 3.12.2. **Initial Calibration Verification (ICV)** - An individual standard, analyzed initially, prior to any sample analysis, which verifies acceptability of the calibration curve or previously established calibration curve.
 - 3.12.3. **Continuing Calibration Verification (CCV)** - An individual standard which is analyzed after every tenth field sample analysis.
- 3.13. **Certified Reference Material** - A reference material one or more of whose property values are certified by a technically valid procedure, accompanied by or traceable to a certificate or other documentation which is issued by a certifying body. (ISO 17025).
- 3.14. **Corrective Action** - Action taken to eliminate the causes of an existing nonconformity, defect or other undesirable situation in order to prevent recurrence. (ISO 8402)
- 3.15. **Deficiency** - An unauthorized deviation from acceptable procedures or practices. (ASQC)

- 3.16. **Demonstration of Capability** -A procedure to establish the ability of the analyst to generate acceptable accuracy. (NELAC)
- 3.17. **Detection Limit** - The lowest concentration or amount of the target analyte that can be determined to be different from zero by a single measurement at a stated degree of confidence.
- 3.18. **Duplicate Analyses** - The analyses or measurements of the variable of interest performed identically on two sub samples (aliquots) of the same sample. The results from duplicate analyses are used to evaluate analytical or measurement precision but not the precision of sampling, preservation or storage internal to the laboratory (EPA-QAD)
- 3.19. **External Standard (ES)** - A pure analyte (Sodium silicofluoride (Na_2SiF_6)) that is measured in an experiment separate from the experiment used to measure the analyte(s) in the sample. The signal observed for a known quantity of the pure external standard is used to calibrate the instrument response for the corresponding analyte(s). The instrument response is used to calculate the concentrations of the analyte(s) in the unknown sample.
- 3.20. **Field Duplicates (FD1 and FD2)** - Two separate samples collected at the same time and place under identical circumstances and treated exactly the same throughout field and laboratory procedures. Analyses of FD1 and FD2 give a measure of the precision associated with sample collection, preservation and storage, as well as with laboratory procedures.
- 3.21. **Holding Time** - The maximum time which samples may be held prior to analysis and still be considered valid. (40 CFR Part 136) The time elapsed from the time of sampling to the time of extraction or analysis, as appropriate.
- 3.22. **Instrument Detection Limit (IDL)** - The minimum quantity of analyte or the concentration equivalent which gives an analyte signal equal to three times the standard deviation of the background signal at the selected wavelength, mass, retention time, absorbance line, etc.
- 3.23. **Laboratory Duplicates (LD1 and LD2)** - Two aliquots of the same sample taken in the laboratory and analyzed separately with identical procedures. Analyses of LD1 and LD2 indicate precision associated with laboratory procedures, but not with sample collection, preservation, or storage procedures.
- 3.24. **Laboratory Reagent Blank (LRB)** - A matrix blank that is treated exactly as a sample including exposure to all glassware, equipment, solvents, and reagents that are used with other samples. The LRB is used to determine if method analytes or other interferences are present in the laboratory environment, the reagents, or the apparatus.
- 3.25. **Laboratory Control Sample (LCS)** - A sample matrix, free from the analytes of interest, spiked with verified known amounts of analytes from a source independent of the calibration standards or a material containing known and verified amounts of analytes. The LCS is generally used to establish intra-laboratory or analyst-specific precision and bias or to assess the performance of all or a portion of the measurement system. (NELAC)
- 3.26. **Limit of Detection (LOD)** - The lowest concentration level that can be determined by a single analysis and with a defined level of confidence to be statistically different from a blank. (ACS)

- 3.27. **Limit of Quantitation (LOQ)** - The minimum levels, concentrations, or quantities of a target variable (target analyte) that can be reported with a specified degree of confidence. The LOQ is set at 3 to 10 times the LOD, depending on the degree of confidence desired.
- 3.28. **Linear Dynamic Range (LDR)** - The absolute quantity over which the instrument response to an analyte is linear. This specification is also referred to as the Linear Calibration Range (LCR).
- 3.29. **Material Safety Data Sheet (MSDS)** - Written information provided by vendors concerning a chemical's toxicity, health hazards, physical properties, fire, and reactivity data including storage, spill, and handling precautions.
- 3.30. **May** - Denotes permitted action, but not required action. (NELAC)
- 3.31. **Method Detection Limit (MDL)** - The minimum concentration of an analyte that can be identified, measured, and reported with 98% confidence that the analyte concentration is greater than zero.
- 3.32. **Must** - Denotes a requirement that must be met. (Random House College Dictionary)
- 3.33. **Photometer** - measures the absorbance of the solution in the cell in a multicell cuvette. Light passes from the lamp through the condensing lenses to the interference filter. The plane surface of the first condensing lens is coated with a material which reflects heat and infrared light. The filters are mounted on a filter wheel. There are 15 positions for filters. Each filter corresponds to a wavelength of interest. The 660 nm filter is specified by the test definition for silicate. After passing through the filter the light is converted into a stream of light pulses by a chopper. Then the light is directed via a quartz fiber through a focusing lens and a slit to the beam divider. The beam divider divides the light into two parts. A specified portion is reflected to the reference detector, which monitors the light level fluctuations. The remaining major portion of the light beam goes through the liquid in the cell to the signal detector, which measures the amount of light absorbed.
- 3.34. **Precision** - The degree to which a set of observations or measurements of the same property, obtained under similar conditions, conform to themselves; a data quality indicator. Precision is usually expressed as standard deviation, variance or range, in either absolute or relative terms. (NELAC)
- 3.35. **Preservation** – Refrigeration, freezing and/or reagents added at the time of sample collection (or later) to maintain the chemical and or biological integrity of the sample.
- 3.36. **Quality Control Sample (QCS)** - A sample of analytes of known and certified concentrations. The QCS is obtained from a source external to the laboratory and different from the source of calibration standards. It is used to check laboratory performance with externally prepared test materials.
- 3.37. **Run** - One sample analysis from start to finish, including printout.
- 3.38. **Run Cycle** – Typically a day of operation – the entire analytical sequence from sampling the first standard to the last sample of the day.
- 3.39. **Sample Segment** – Bar-coded metal tray that holds up to fourteen four milliliter auto analyzer vials containing samples or standards. The user identifies each vial in the operating software.

- 3.40. **Sample Segment Holder** – An automated temperature controlled carousel that contains up to six sample segments. This carousel spins in clockwise or counterclockwise manner to move the sample segments into position for analysis. This carousel format allows for continuous processing.
- 3.41. **Sensitivity** - The capability of a test method or instrument to discriminate between measurement responses representing different levels (concentrations) of a variable of interest.
- 3.42. **Shall** - Denotes a requirement that is mandatory whenever the criterion for conformance with the specification requires that there be no deviation. (ANSI)
- 3.43. **Should** - Denotes a guideline or recommendation whenever noncompliance with the specification is permissible. (ANSI)
- 3.44. **Standard Reference Material (SRM)** - Material which has been certified for specific analytes by a variety of analytical techniques and/or by numerous laboratories using similar analytical techniques. These may consist of pure chemicals, buffers, or compositional standards. The materials are used as an indication of the accuracy of a specific analytical technique.
- 3.45. **Test Definition** – A photometric test consisting of a user defined testing sequence, reagent additions, calibration standards, incubations and absorption results.
- 3.46. **Test Flow** – Functions to define the parameter for reagent and sample dispensing, dilution, incubation and measurement

4. INTERFERENCES

- 4.1. Because both apparatus and reagents may contribute silica, avoid using glassware as much as possible and use reagents low in silica. Phosphate interference can be eliminated by the addition of oxalic acid.
- 4.2. Suspended matter in the sample will scatter light as it passes through the cuvette to the detector. High blank responses will result. The identified sample will be reanalyzed.
- 4.3. Blemishes in the cuvette, as result of the manufacturing process, will result in high blank responses. The identified sample will be reanalyzed.

5. SAFETY

- 5.1. Safety precautions must be taken when handling reagents, samples and equipment in the laboratory. Protective clothing including lab coats and safety glasses and enclosed shoes must always be worn. In certain situations it may also be necessary to use gloves and goggles. If solutions or chemicals come in contact with eyes, flush with water continuously for 15 minutes. If solutions or chemicals come in contact with skin, wash thoroughly with soap and water. Contact Solomons Rescue Squad (911) if emergency treatment is needed and also inform the CBL Business Manager of the incident. Contact the CBL Business Manager if additional treatment is required.
- 5.2. The toxicity or carcinogenicity of each reagent used in this procedure may not have been fully established. Each chemical should be regarded as a potential health

hazard and exposure should be as low as reasonably achievable. Cautions are included for known extremely hazardous materials and procedures.

- 5.3. Do not wear jewelry when troubleshooting electrical components. Even low voltage points are dangerous and can injure if allowed to short circuit
- 5.4. The following hazard classifications are listed for the chemicals regularly used in this procedure.

Chemical	Health	Flammability	Reactivity	Contact	Storage
Sulfuric acid	4	0	2	4	White
Oxalic acid	2	1	1	3	White
Ascorbic acid	1	1	1	1	Green
Ammonium molybdate	2	0	1	2	Green
Potassium phosphate	0	0	0	1	Green
Sodium silicofluoride	2	0	0	2	Green
On a scale of 0 to 4 the substance is rated on four hazard categories: health, flammability reactivity, and contact. (0 is non-hazardous and 4 is extremely hazardous)					
STORAGE					
Red - Flammability Hazard. Store in a flammable liquid storage area.					
Blue - Health Hazard. Store in a secure poison area.					
Yellow - Reactivity Hazard. Keep separate from flammable and combustible materials.					
White - Contact Hazard. Store in a corrosion-proof area.					
Green - Use general chemical storage (On older labels, this category was orange).					
Striped - Incompatible materials of the same color class have striped labels. These Products should not be stored adjacent to substances with the same color label. Proper storage must be individually determined.					

6. EQUIPMENT AND SUPPLIES

- 6.1. Aquakem 250 multi-wavelength automated discrete photometric analyzer. Aquakem 250 control software operates on a computer running Microsoft Windows NT or XP operating system.
- 6.2. Freezer, capable of maintaining $-20 \pm 5^{\circ} \text{C}$.
- 6.3. Refrigerator, capable of maintaining $4 \pm 2^{\circ} \text{C}$.
- 6.4. Lab ware – All reusable lab ware (glass, Teflon, plastic, etc) should be sufficiently clean for the task objectives. This laboratory cleans all lab ware related to this method with a 10% HCl (v/v) acid rinse, followed by 4-6 deionized water rinses. This laboratory cleans all lab ware that has held solutions containing ammonium molybdate with 10% NaOH (w/v) rinse.

7. REAGENTS AND STANDARDS

- 7.1. Purity of Water – Unless otherwise indicated, references to water shall be understood to mean reagent water conforming to Specification D 1193, Type I. Freshly prepared water should be used for making the standards intended for calibration. The detection limits of this method will be limited by the purity of the water and reagents used to make the standards.
- 7.2. Purity of Reagents – Reagent grade chemicals shall be used in all tests. Unless otherwise indicated, it is intended that all reagents shall conform to specifications of the Committee on Analytical Reagents of the American Chemical Society, where

such specifications are available. Other grades may be used, provided it is first ascertained that the reagent is of sufficiently high purity to permit its use without compromising the accuracy of the determination.

7.3. Oxalic Acid Solution -

Oxalic acid ($\text{H}_2\text{C}_2\text{O}_4 \cdot 2\text{H}_2\text{O}$)	100g
Deionized water	up to 1000mL

In a 100mL plastic volumetric flask, dissolve 100g of oxalic acid in ~900mL deionized water and dilute to 100mL with deionized water. Write name of preparer, preparation date, reagent manufacturer, manufacturer's lot number in the Analytical Reagent log book. Store the flask at room temperature in the dark and make every 6-9 months.

7.4. Ascorbic Acid Solution -

Oxalic acid ($\text{H}_2\text{C}_2\text{O}_4 \cdot 2\text{H}_2\text{O}$)	5g
Ascorbic acid ($\text{C}_6\text{H}_8\text{O}_6$), U.S.P. quality	100g
Deionized water	up to 1000mL

In a 100mL plastic volumetric flask, dissolve 5g of oxalic acid in ~800mL of deionized water. Add 100g of ascorbic acid and mix until dissolved. Dilute to 1000mL with deionized water. Write name of preparer, preparation date, reagent manufacturers, manufacturers' lot numbers in the Analytical Reagent log book. Divide into 4-6 bottles and freeze until needed. Thawed bottles should be stored at 4°C. Make every 6-9 months.

7.5. Ammonium Molybdate Solution -

Ammonium molybdate [$(\text{NH}_4)_6\text{Mo}_7\text{O}_{24} \cdot 4\text{H}_2\text{O}$]	3.0g
Deionized water	up to 100mL

In a 100mL plastic volumetric flask, dissolve 3.0g ammonium molybdate in ~80mL of deionized water. Dilute to 100mL with deionized water. Write name of preparer, preparation date, reagent manufacturer, manufacturer's lot number in the Analytical Reagent log book. Store in the dark at room temperature. Make every other day.

7.6. Stock Phosphate Solution -

Potassium phosphate (KH_2PO_4), dried at 45°C	0.4394g
Deionized water	up to 1000mL

In a 1000mL volumetric flask, dissolve 0.4394g of potassium phosphate in ~600mL of deionized water. Dilute to 1000mL with deionized water. Write name of preparer, preparation date, reagent manufacturer, manufacturer's lot number in the Analytical Reagent log book. Store the flask at room temperature. Prepare fresh when making 0.7 N sulfuric acid solution.

7.7. Sulfuric Acid Solution -

Sulfuric acid (H_2SO_4), concentrated (sp. Gr. 1.84)	4.06mL
Stock phosphate solution	21.4 mL
Deionized water	up to 1000mL

In a 1000mL plastic volumetric flask, add 4.06mL of concentrated sulfuric acid and 21.4mL of stock phosphate solution to ~600mL of deionized water. Dilute to 1000mL with deionized water. Write name of preparer, preparation date, reagent manufacturer, manufacturer's lot number in the Analytical Reagent log book. Store at 4°C and make every 6-9 months.

7.8. Stock Silicate Standard, 10,000uM

Sodium silicofluoride (Na_2SiF_6), dried at 45°C	1.88g
Deionized water	up to 1000mL

In a 1000mL volumetric flask, dissolve 1.88g of sodium silicofluoride in ~900mL of deionized water. Dilute to 1000mL with deionized water (1ml contains 10umoles Si). Write name of preparer, preparation date, standard manufacturer, manufacturer lot number in the Analytical Standard log book. Store in a plastic container. Make fresh every 6 months.

7.9 Aquakem Cleaning Solution –

Clorox	75.0 mL
--------	---------

In a 100 mL volumetric flask, dilute 75.0 mL of Clorox to volume with deionized water to yield a concentration of 75% Clorox. Write name of preparer, preparation date, reagent manufacturer, manufacturer lot number in the Analytical Reagent log book. Reagent is stable for six months.

8. SAMPLE COLLECTION, PRESERVATION AND STORAGE

- 8.1. Water collected for Si should be filtered through a Whatman GF/F glass fiber filter (nominal pore size 0.7 μm), or equivalent.
- 8.2. Water collected for Si should be refrigerated at 4° C. The sample container should be clean and sample rinsed.
- 8.3. Refrigerated Si samples may be stored longer than 28 days. It has been shown that refrigerated QCS samples up to a year old still fall well within the control limits.

9. QUALITY CONTROL

- 9.1. The laboratory is required to operate a formal quality control (QC) program. The minimum requirements of this program consist of an initial demonstration of laboratory capability and the continued analysis of laboratory instrument blanks field duplicates, and calibration standards analyzed as samples as a continuing check on performance. The laboratory is required to maintain performance records that define the quality of data generated.
- 9.2. **Initial Demonstration of Capability**
 - 9.2.1. **The initial demonstration of capability (DOC)** – is used to characterize instrument performance (MDLs) and laboratory performance (analysis of QC samples) prior to the analyses conducted by this procedure.
 - 9.2.2. **Quality Control Sample (QCS/SRM)** – When using this procedure, a quality control sample is required to be analyzed at the beginning or middle and end of the run, to verify data quality and acceptable instrument performance. If the determined concentrations are not within $\pm 10\%$ of the certified values, performance of the determinative step of the method is unacceptable. The source of the problem must be identified and corrected before proceeding with the initial determination of MDLs.

- 9.2.3. **Method Detection Limits (MDLs)** – MDLs should be established for Si using a low level estuarine water sample, typically three to five times higher than the estimated MDL. The same procedure should be followed for sediments or other weighed samples. To determine the MDL values, analyze seven replicate aliquots of water and process through the entire analytical procedure. Perform all calculations defined in the procedure (Section 12) and report the concentration values in the appropriate units. Calculate the MDL as follows:

$$\text{MDL} = 3 \times S$$

Where, S = Standard deviation of the replicate analyses.

- 9.2.4. MDLs should be determined annually, whenever there is a significant change in instrumental response, change of operator, or a new matrix is encountered.

9.3. Assessing Laboratory Performance

- 9.3.1. **Laboratory Reagent Blank (LRB)** – The laboratory must analyze at least one LRB with each batch of samples. The LRB consists of Nanopure water treated the same as the samples. Analyte found in LRB indicates possible reagent or laboratory environment contamination. LRB data are used to assess and correct contamination from the laboratory environment. LRB above the lowest standard requires that the source of the problem must be identified and corrected before proceeding with analyses.
- 9.3.2. **Quality Control Sample (QCS)/ Standard Reference Material (SRM)** - When using this procedure, a quality control sample is required to be analyzed at the beginning and end of the run, to verify data quality and acceptable instrument performance. If the determined concentrations are not within $\pm 3\sigma$ of the certified values, performance of the determinative step of the method is unacceptable. The source of the problem must be identified and corrected before either proceeding with the initial determination of MDLs or continuing with the analyses. The results of these QCS/SRM samples shall be used to determine batch acceptance.
- 9.3.3. The QCS are obtained from a source external to the laboratory and different from the source of calibration standards.
- 9.3.4. **Control Charts** – The Accuracy Control Chart for QCS/SRM samples is constructed from the average and standard deviation of the 20 most recent QCS/SRM measurements. The accuracy chart includes upper and lower warning levels ($WL=\pm 2s$) and upper and lower control levels ($CL=\pm 3s$). These values are derived from stated values of the QCS/SRM. The standard deviation (s) is specified relative to statistical confidence levels of 95% for WLs and 99% for CLs. Set up an accuracy chart by using percent recovery since the concentration of the QCS/SRM varies. Enter QCS/SRM results on the chart each time the sample is analyzed
- 9.3.5. **Continuing Calibration Verification (CCV)** – Following every 18-23 samples, one CCV of 50 μM Si/L (1.4 mg Si/L) for Regular Si, 250 μM Si/L (7.0 mg Si/L) for Si HIGH is analyzed to assess instrument performance. The CCVs are made from the same material as calibration standards (Na_2SiF_6), and are to be within $TV \pm 3s$. Failure to meet the criteria requires correcting the

problem, including reanalysis of any affected samples. If not enough sample exists, the data must be qualified if reported.

- 9.3.6. **Reagent Blank** – The Reagent Blank Control Chart for Reagent Blank samples is constructed from the average and standard deviation of the 20 most recent Reagent Blank measurements. The accuracy chart includes upper and lower warning levels ($WL=\pm 2s$) and upper and lower control levels ($CL=\pm 3s$). The standard deviation (s) is specified relative to statistical confidence levels of 95% for WLs and 99% for CLs. Enter Reagent Blank results on the chart each time the Reagent Blank is analyzed.
- 9.4. **Assessing Analyte Recovery**
- 9.4.1. Analyte recovery is assessed through percent recoveries of laboratory spikes.
- 9.4.2 $\% \text{ Recovery} = (\text{Spiked sample concentration} - \text{Sample concentration} / \text{Concentration of spike solution}) \times 100$
- 9.5. **Assessing Analyte Precision** – Relative Percent Difference
- 9.5.1. Analyte replication is assessed through duplicate analyses of samples – Relative Percent Difference.
- 9.5.2. $RPD = (\text{Laboratory Duplicate Result 1} - \text{Laboratory Duplicate Result 2}) / [(\text{Laboratory Duplicate Result 1} + \text{Laboratory Duplicate Result 2}) / 2] \times 100$
- 9.6. **Corrective Actions for Out-Of-Control Data**
- 9.6.1. Control limit – If one measurement exceeds Accuracy Control Chart CL, repeat the analysis immediately. If the repeat measurement is within the CL, continue analyses; if it exceeds the CL, discontinue analyses and correct the problem.
- 9.6.2. Warning limit – If two out of three successive points exceed Accuracy Control Chart WL, analyze another sample. If the next point is within WL, continue analyses; if the next point exceeds the WL, evaluate potential bias and correct the problem.
- 9.6.3. Trending – If seven successive Accuracy Control Chart measurements are on the same side of the central line, discontinue analyses and correct the problem.
- 9.6.4. When external QCS samples are out of control, correct the problem. Reanalyze the samples analyzed between the last in-control measurement and the out-of-control one.
- 9.6.5. When external CCV samples are out of control, correct the problem. Reanalyze the samples analyzed between the last in-control measurement and the out-of-control one.
- 9.7. **General Operation** - To assure optimal operation and analytical results, the Reagent Blank and CCV are tracked daily in the raw data file, copied to Reagent Blank and CCV Control Charts

10. CALIBRATION AND STANDARDIZATION

- 10.1. **Calibration** - Daily calibration must be performed before sample analysis may begin. Five point calibrations are specified for silicate calibration with the AquaKem 250 analyzer.
- 10.2. **Working Silicate Standards** – For the low curve (SILCBL), dilute 0.75 mL and 0.5 mL of Stock Silicate Standard to 100 mL with deionized water to yield

concentrations of 75 μM Si (2.1 mg Si/L) for working calibration standard and 50 μM Si (1.4 mg Si/L) for working CCV, respectively. For the high curve (SILCBLHI), dilute 3.75 mL and 2.5 mL of Stock Silicate Standard to 100 mL with deionized water to yield concentrations of 375 μM Si (10.5 mg Si/L) for working calibration standard and 250 μM Si (7.0 mg Si/L) for working CCV, respectively. Write name of preparer, preparation date, Stock Standard preparation date in the Analytical Standard log book. Make fresh every month. The AquaKem 250 uses the working standard for each calibration curve to produce the five defined dilutions for the calibration curve.

10.3. Silicate Calibrators:

Test Name	Working Standard	Dilution Factor	Concentration mg Si/L
SILCBL	2.1 mg Si/L	1+9	0.21
	2.1 mg Si/L	1+4	0.42
	2.1 mg Si/L	1+2	0.70
	2.1 mg Si/L	1+1	1.05
	2.1 mg Si/L	1+0	2.10
SILCBLHI	10.5 mg Si/L	1+9	1.05
	10.5 mg Si/L	1+4	2.10
	10.5 mg Si/L	1+2	3.50
	10.5 mg Si/L	1+1	5.25
	10.5 mg Si/L	1+0	10.5

The instrument software prepares a standard curve for each set of calibrators. A graph plotting measured absorbance against standard concentration is presented for review and approval. If acceptance criteria are not met the entire curve can be reanalyzed or individual standards can be reanalyzed. One standard value (original or reanalyzed) for each and every standard is incorporated in the curve. The coefficient of determination (Person's r value) for the calibration curve as well as the calculated concentration of each calibrator is reviewed. The calculated value of each calibrator must be within ten percent of the expected value. The coefficient of determination (Person's r value) for the calibration curve must be greater than 0.980.

11. PROCEDURE – DAILY OPERATIONS AND QUALITY CONTROL

- 11.1. Turn on computer. Computer will automatically initiate Konelab software. Once software is running, turn on instrument and allow connection between instrument and computer to complete.
- 11.2. Discard any water remaining in the water reservoir from the previous analytical run. Fill the water reservoir with fresh deionized water.

- 11.3. Remove from refrigerator samples that will be analyzed that day. Begin daily bench sheet documentation. Remove SRM from refrigerator as well.
- 11.4. Once water reservoir is full, “perform washes” – complete five wash cycles and then initiate “start-up” at main menu.
- 11.5. Gather working standards and reagents from refrigerator during startup. Assess standards and reagents. Remake anything that has exceeded the time over which it is considered stable. Molybdate reagent is made every other day.
- 11.6. Once startup is complete, check that the instrument water blank has performed within acceptance limits. If any of the instrument functions are outside their predefined and software controlled limits, the user will be notified on the main menu page. User takes corrective action to return instrument functions to controlled limits.
- 11.7. Load reagents into reagent carousel and place into refrigerated reagent compartment.
- 11.8. Load working standards into a sample segment, identify the standards in their positions from the drop down menus at the individual segment positions, and load into instrument.
- 11.9. Select the methods to be calibrated. Two methods will be calibrated – SILCBL, and SILCBLHI.
- 11.10. Begin calibration – See test flow below for stepwise instrument functions for the analysis of standards and samples.

Test Flow – Method of Analysis, Stepwise

- 100 μ L SAMPLE to cuvette
 - End point absorbance measurement at 660 nm for sample blank determination
 - 31 μ L sulfuric acid solution (H2S SILCBL) to cuvette with mixing
 - 39 μ L ammonium molybdate solution (MOL SILCBL) reagent to cuvette with mixing
 - Incubation, 30 seconds
 - 62 μ L oxalic acid solution (OXA SILCBL) to cuvette with mixing
 - Incubation, 30 seconds
 - 16 μ L ascorbic acid solution (ASC SILCBL) to cuvette with mixing
 - Incubation, 600 seconds
 - End point absorbance measurement, 660 nm
 - Software processes absorbance value and uses calibration curve to calculate analyte concentration (mg/L of Si)
 - User is notified if any measured values used to calculate final concentration are outside preset limits. If so, user has options to accept result, rerun the sample or rerun the sample diluted to a user or software specified factor.
- 11.11. Organize samples, reagent blanks, check standards and all quality control samples while instrument performs calibrations.
 - 11.12. As calibration curves are produced by the instrument, review them for acceptability. The instrument software prepares a standard curve for each set of calibrators. A graph plotting measured absorbance against standard concentration is presented for review and approval. If acceptance criteria are not

- met, either the entire curve shall be reanalyzed or individual standards shall be reanalyzed, depending on the violation.
- 11.13. Once calibration curves are accepted, samples are loaded into the sample segments and loaded into the instrument for analysis. The first samples analyzed should be ICV (initial calibration verification) samples. There should be one sample for each calibration curve, of a concentration close to the middle of each range. The following are the usual ICV samples for each curve: 1.4 mg Si/L for SILCBL, and 7.0 mg Si/L for SILCBLHI.
 - 11.14. Samples are loaded into the segments and analyzed. CCV (Continuing Calibration Verification) samples (one for each of the two calibration ranges) follow every 18-23 samples. Standard Reference Material (SRM) samples as well as Laboratory Reagent Blanks (LRB) are scattered throughout the analytical batch. Throughout the analytical batch, samples are chosen as laboratory duplicates and laboratory spikes to assess analyte precision and analyte recovery, respectively. The total number of duplicates and spikes performed will be equal or greater to ten percent of the total number of samples in the analytical batch.
 - 11.15. As sample analysis is complete, results must be reviewed and accepted manually. If results fall outside acceptance limits, the sample should be reanalyzed. If sample result exceeds the highest standard of the calibration range it was run within, the samples can be automatically diluted by the instrument and reanalyzed. If the result is such that it will fall within a higher calibration range, it should be reanalyzed in that range. If the result is such that it will fall within a lower calibration range, it should be reanalyzed within that range.
 - 11.16. Upon completion of all analysis, results should be saved to a daily report file. The file is named by the run date. The daily report file for analytical batch of January 2, 2005 would be named 010205. The file is converted to Microsoft Excel for data work up and copied to a removable flash drive. The sample results are printed in order to maintain a hard copy. Remaining samples are discarded.
 - 11.17. All reagents are removed from the reagent chamber and returned to the refrigerator. Reagents that have exceeded their stability period are discarded.
 - 11.18. AquaKem Cleaning Solution is inserted into the instrument and shut down procedures are initiated. Daily files are cleared from the instrument software, the software is exited and the instrument is shut down. The computer is shut down. The instrument is shut off. The waste is flushed down the drain with copious amounts of tap water. The waste cuvette box is moved to the fume hood. The instrument is wiped clean of drips or splashes.

12. DATA ANALYSIS AND CALCULATIONS

- 12.1. Upon completion of all analysis, results are saved to a daily report file. The file is named by the run date. The daily report file for analytical batch of January 1, 2005 would be named 010105. Raw results for each run are copied into a Lotus123 or Microsoft Excel spreadsheet. Data are sorted by sample name and

time of analysis so that all samples will be displayed by number and results for each sample will be displayed consecutively.

- 12.2. Dilution by the instrument is noted by software as analysis ensues and, also, documented in the data report spreadsheet. Analyst edits results taking into account dilutions and scale, and discarding values with unrepeated high blank response greater than 0.001 absorbance units.
- 12.3. Example of sorted and edited spreadsheet of results:

	A	B	B	C	D
1	AquaKem v. 6.5 AQ1				
2	KATHRYN WOOD:				
3	Fri Feb 27 09:11:41 2009				
4	SAMPLE BATCH NAME				
5	SAMPLE BATCH DATE				
6					
7	SAMPLE	MG Si/L			
8	1	2.11			
9	2	3.50			
10	3	1.42			
10	4	0.43			
11	5	1.32			
12	6	0.81			
13	7	1.58			
14	8	3.79			
15	9	2.91			
16	10	5.10			
17	Si SPEX 11/2008	0.93			
18	DHOH	0.01			
19	1.4 Si QC	1.41			
20	7.0 Si QC	7.02			
21					

- 12.3.1. Cell 1A – Instrument and software version
- 12.3.2. Cell 2A – Analyst's name
- 12.3.3. Cell 3A – Date and time of start-up
- 12.3.4. Cell 4A – Sample batch name
- 12.3.5. Cell 5A – Sample batch date
- 12.3.6. Cell 7A – Column heading for sample
- 12.3.7. Cell 7B - Column heading for Si concentration in units of mg Si/L
- 12.3.8. Cells 8A to 16B – Sample Results table.
- 12.3.9. Cell 17A – SRM name and date
- 12.3.10. Cell 17B – SRM concentration, mg Si/L
- 12.3.11. Cell 18A – Deionized water blank name (DHOH)
- 12.3.12. Cell 18B – DHOH concentration, mg Si/L
- 12.3.13. Cells 19A and Cell 20A – CCV name
- 12.3.14. Cells 19B and 20B – CCV concentration, mg Si/L
- 12.4. Report analyte concentrations to two significant figures.

13. METHOD PERFORMANCE

- 13.1. The procedure validation MDL, based on seven filtrations of an estuarine sample, was found to be 0.01 mg Si/L for silicate.
- 13.2. Twenty-seven analyses on separate dates of the Silicate SRM, from 1/2008 to 3/2009, produced an average value of 0.88 +/- 0.02 mg Si/L. The true value for the QC is 0.94 mg Si/L. This is an average recovery of 93.4%.
- 13.3. Twenty-seven analyses on separate dates of the 1.40 mg Si/L and 7.0 mg Si/L CCVs from 1/2008 to 3/2009, produced the following values respectively: 1.42 +/- 0.04 mg Si/L and 7.12 +/- 0.09 mg Si/L. This is an average recovery of 101.4% for the low curve, and 101.7% for the high curve.

14. POLLUTION PREVENTION

- 14.1. Pollution prevention encompasses any technique that reduces or eliminates the quantity of toxicity of waste at the point of generation. Numerous opportunities for pollution prevention exist in laboratory operation. The USEPA has established a preferred hierarchy of environmental management techniques that places pollution as the management option of first choice. Whenever feasible, laboratory personnel should use pollution prevention techniques to address their waste generation. When wastes cannot be feasibly reduced at the source, the agency recommends recycling as the next best option.
- 14.2. For information about pollution prevention that may be applicable to laboratories and research institutions, consult "Less is Better: Laboratory Chemical Management for Waste Reduction", available from the American Chemical Society, Department of Government Relations and Science Policy, 1155 16th Street N. W., Washington, D.C. 20036.

15. WASTE MANAGEMENT

- 15.1. The reagents used in this procedure are minimal and are not hazardous with the exception of the sulfuric acid. Due to the small quantity used, the sulfuric acid and other reagents can be flushed down the drain with running water.
- 15.2. For further information on waste management consult The Waste Management Manual for Laboratory Personnel, available from the American Chemical Society.

16. REFERENCES

- 16.1. U.S. Environmental Protection Agency, 1997. Methods for the Determination of Chemical Substances in Marine and Estuarine Environmental Samples. Method 366.0. U.S. Environmental Protection Agency. Washington, D.C.
- 16.2. Grasshoff, K., M. Ehrhardt and K. Kremling (eds). 1983. Methods of Seawater Analysis. Verlag Chemie. Weinheim, Germany.

- 16.3. Frank, J. M., C.F. Zimmermann and C. W. Keefe (2006). Comparison of results from Konelab Aquakem 250 and existing nutrient analyzers. UMCES CBL Nutrient Analytical Services Laboratory, Dec. 2006.

APPENDIX VIII

MARYLAND DEPARTMENT OF NATURAL RESOURCES CHESAPEAKE BAY WATER QUALITY MONITORING PROGRAM

SPLIT SAMPLE PROGRAM

The following summary is a summary of the split sample program excerpted from the *Recommended Guidelines for Sampling and Analysis in the Chesapeake Bay Monitoring Program*. (EPA 1996). Information about the Split Sample and Blind Sample Programs program is available on-line at the EPA Chesapeake Bay Program web site: http://www.chesapeakebay.net/qualityassurance_splitsample.aspx.

Background and Objectives

The Chesapeake Bay Coordinated Split Sample Program (CSSP) was established in June 1989 by recommendation of AMQAW [the Chesapeake Bay Program Analytical Methods and Quality Assurance Workgroup], to the Monitoring Subcommittee. The major objective of this program is to establish a measure of comparability between sampling and analytical operations for water quality monitoring basin-wide. A secondary objective is to evaluate the in-matrix dilution of standard U.S. Environmental Protection Agency (EPA) reference materials. These standard reference materials are analyzed in appropriate matrix, fresh to saline, and concentration level to match the sample. All laboratories participating in basin-wide data collection programs are also required to participate in the CSSP. For additional information on the program, please consult *Chesapeake Bay Coordinated Split Sample Program Implementation Guidelines Revision3* (EPA 1991).

Summary of Criteria

- (1) The Participant will participate in the applicable component(s) of the CSSP.
- (2) The Standard Operating Procedures (SOPs) that are developed and used should be in accordance with the Chesapeake Bay Coordinated Split Sample Program Implementation Guidelines CBP/TRS 58/91, May 1991 plus any revisions specified by the CBP Quality Assurance Officer.
- (3) For each of the Virginia and Maryland CSSP stations and on a quarterly basis, the Participant will receive and analyze four sub-samples. Since 1998, Maryland DNR has performed the sample split at one station and depth, (usually the surface sample at station CB4.4C).

Four sub samples will be collected for each participating laboratory. Samples to be analyzed at Virginia Labs will be delivered to Port Royal, VA, the afternoon of the day they are collected and processed the following morning. In order to treat all of the samples uniformly, the MD DNR field team will also wait until the next morning to process their split samples.

Laboratories currently participating in the program are: University of Maryland Chesapeake Biological Laboratory Nutrient Analytical Services Laboratory (CBL), Virginia Institute of Marine Science (VIMS), Old Dominion University College of Sciences Water Quality Laboratory (ODU), Virginia Division of Consolidated Laboratory Services (VADCLS), and Morgan State University (MSU). Beginning in Feb 2010 VIMS has reduced participation to

twice a year May and August. Morgan State's last participation was August 2009. MSU funding was cut in Oct 2009.

Treating each sub-sample as a discrete sample, participating laboratories are generally required to perform only those analyses which they routinely perform in support of basin-wide data collection program. One of the three sub-samples should be used to generate laboratory duplicates and a laboratory spike. These quality control (QC) samples should be analyzed concurrently with the associated CSSP sub-samples.

- (4) The routine submission of split sample data is the responsibility of each laboratory and its in-house data management organization.
- (5) To supplement the analyses of the three sub-samples and the respective QC sample, EPA standard reference materials provides a strong measure of comparability between all laboratories and within one laboratory's analytical system over time. Quarterly analysis of Standard Reference Materials (SRMs) is the most independent evaluation of laboratory performance available at this time. It is a critical element of any diagnostic efforts associated with the CSSP.

Examples of Split Sample information sheets and Custody Logs

An example of the field sheet used to record sample number, time of collection and salinity when split sample water is collected follows. Volumes are filled in the next morning when samples are processed for the Laboratories.

An example of a log sheet used to document the split sample Chain of Custody follows.

REFERENCES:

U.S. Environmental Protection Agency (EPA). 1996. *Recommended Guidelines for Sampling and Analysis in the Chesapeake Bay Monitoring Program*. Chesapeake Bay Program, August 1996. CBP/TRS 148/96; EPA 903-R-96-006. http://archive.chesapeakebay.net/pubs/quality_assurance/doc-EPA903-R-96-006.pdf

U.S. Environmental Protection Agency (EPA). 1991. *Chesapeake Bay Coordinated Split Sample Program Implementation Guidelines* Chesapeake Bay Program, May 1991. CBP/TRS 58/91 is available as document# 903R91006 via the EPA online publication server at the National Service Center for Environmental Publications (NSCEP): <http://nepis.epa.gov/Exe/ZyPURL.cgi?Dockey=2000VYDR.txt>.

Split Sample Information sheet example:

CBL SHEET

DATE _____

SCIENTIST SIGNOFF _____

DNR-MANTA
MAINSTEM QAQC SPLIT

station	bottle #	sample #	layer	depth (m)	time collected	salinity ppt	TSS/VSS vol (ml)	PP/PIP vol (ml)	CHLA vol (ml)	PC/PN vol (ml)
CB4.4	C-1		S	0.5						
CB4.4	C-2		S	0.5						
CB4.4	C-3		S	0.5						
CB4.4	C-4		S	0.5						

date/time processed _____

TSS/VSS/PP processed by _____

PC/PN/Chla processed by _____

Place this completed sheet with the other sheets going to CBL. Please include any chain of custody sheets along with this sheet. These samples remain with the other CBL mainstem samples.

Split Sample Custody Log Example:

MAIN BAY SPLIT SAMPLE CUSTODY LOG

BOTTLE NUMBERS: A1,A2,A3,A4

LOCATION: CB4.4

COLLECTED FOR: VIMS

COLLECTION DETAILS: DATE: _____ TIME: _____ DEPTH: 0.5M
 SALINITY: _____ PPT

COMMENTS: (unusual conditions, problems, floating algae, rain, etc.)

=====

SPLITTING DETAILS:	COMPOSITE SUB SPLIT BY:
COMPOSITE CONTAINER	sequential bottles
FILLED BY: submersible pump @ 0.5 m into a 30 gallon Nalgen container	

Splitting Sequence

Order #	Agency	order #	Agency	order #	Agency	order #	Agency
1---	A1 VIMS	6---	A2 VIMS	11---	A3 VIMS	16---	A4 VIMS
2---	B1 ODU	7---	B2 ODU	12---	B3 ODU	17---	B4 ODU
3---	C1 CBL	8---	C2 CBL	13---	C3 CBL	18---	C4 CBL
4---	D1 VADCLS	9---	D2 VADCLS	14---	D3 VADCLS	19---	D4 VADCLS
5---	E1 MSU	10---	E2 MSU	15---	E3 MSU	20---	E4 MSU

=====

TRANSFER SEQUENCE:	DATE	TIME	BY WHOM?	TEMP. OF SAMPLE
Composite collected & split	_____	_____	DNR/_____	(circle one) ambient
Subsample picked up	_____	_____	_____	0°C 4°C ambient
Subsamples delivered to lab	_____	_____	_____	0°C 4°C ambient

=====

FIELD PROCESSING INFORMATION

BOTTLE #	FIELD PROCESSING DONE	DATE/TIME	BY WHOM?

NOTE: PLEASE SEND A COPY OF THIS COMPLETED FORM TO: Main Bay Split, Renee Randall Maryland Dept of Natural Resources, TEA/D-2, 580 Taylor Avenue, Annapolis MD, 21401, (410) 260-8629.

APPENDIX IX

MARYLAND DEPARTMENT OF NATURAL RESOURCES CHESAPEAKE BAY WATER QUALITY MONITORING PROGRAM

DATA STATUS FORM DOCUMENTATION AND PROCEDURES

The Data Status Form is used for all monthly water quality data for all monitoring projects. The form is designed to facilitate data management by tracking data management activities and identifying potential problems for remedy early in the process. Upon receiving the data sheets or files from the data source agencies (e.g., the Field Office and the laboratories), the data clerk initiates a Data Status Form, which then accompanies the data sheets/files. When all of data have been processed for that month, the Data Status Form is stored with the data sheets and other computer generated information at the DNR Tawes Office Building in Annapolis.

This sheet was developed in 1986 and updated in 1995. An updated web-based data status tracking form is being designed and will be implemented in the future. Note that many of the columns on the form are no longer actively used. The necessary information in the sheet is described in the following paragraphs. An example Data Status Form is attached for reference.

I. COMPLETE THE FOLLOWING WHEN THE FORM IS ISSUED:

1. DATE INITIATED (UPPER RIGHT HAND CORNER)

Indicate the date when the form is issued. In general, issue the form upon receiving the first group of data sheets and/or data files from data source agencies for a given month.

2. DATA SET NAME

Enter the data set name with the project abbreviation, data sampling month, year, and data type (e.g., TJAN98FD for tributary field data for January 1998). Refer to the detailed description of naming conventions at the end of this appendix.

3. DATA RECEIVED

Upon receiving the first group of data sheets and/or data files, enter the date and initial in this field.

II. COMPLETE THE FOLLOWING UPON FINISHING THE DATA MANAGEMENT PROCESS

1. DATA REVIEWED

Once all monthly data sheets and/or data files have been received and the data have been reviewed, enter completion date. Initial in this field.

2. CROSS REFERENCE

If the completed cross reference sheets are included with the incoming data sheets, enter the date and initial in this field. If, for some reason, cross reference sheets are not included, the Quality Assurance Officer would be notified, and s/he would contact the field office.

3. XEROXING

Before sending field data sheets to the data entry service agency, copy data sheets and send originals to the data entry service agency. Enter the completion date and initial in this field.

4. DATA ENTRY – SENT

Enter the date data sheets are sent to data entry service in this field. Initial.

5. DATA ENTRY – RETURNED

Enter the date that data sheets and data diskette are received from data entry service in this field. Initial.

6. INITIAL DATA CHECK

7. DATA VERIFICATION

8. TEMPORARY MERGE(S)

BIO CHECK (#9 - #13)

9. VERIFICATION(S)

10. EDIT(S) IDENTIFIED

11. DATA CORRECTION(S)

12. TEMPORARY MERGE(S)

13. BIOLOGIST SIGN OFF

14. FINAL DATA CORRECTION

15. MERGE COMPLETED

16. GENERATE MS ACCESS DATA SET

17. GENERATE EPA MS ACCESS DATA (This field generally is left blank–this step is included under “PRODUCE CBP DATA TRN FILE.”)

18. SUBMISSION DOCUMENT (This field generally is left blank–this step is included under “PRODUCE CBP DATA TRN FILE.”)

19. SUBMISSION LETTER (This field generally is left blank–this step is included under “PRODUCE CBP DATA TRN FILE.”)

20. FINAL SIGN-OFF

Upon verifying all of the above data management processes and ensuring that all corrections have been made, finalize the data set in the state data base system by running permanent merge process in the EZMERGE system, enter the completion date and initial in this field.

21. SUBMISSION TO CBP (PRODUCE CBP DATA TRN FILE)

Upon successfully creating data submission file, report, and document for the monthly data submission process, enter the completion date in this field and initial.

22. CBP ACCEPTS / SIGN OFF

After receiving the checklist and ACCEPTS/SIGN OFF form from CBP and upon completing all the necessary data verification actions (e.g., double checking errors), put the completion date in this field and initial.

NOTE: Any special comments can be entered in the COMMENTS column during the data management activities.

CONVENTIONS FOR NAMING THE DATA SET

An eight-character text string is used for this data set name. This section contains the naming conventions for data set names for all monitoring projects. Any new sampling monitoring and data collection projects must follow these conventions.

1. CHESAPEAKE BAY MAINSTEM MONITORING PROJECT

Data Set Name: MMMYYDDD

Description: The data set name contains the data sampling month, year, and data type only. The first three characters of the data set name (MMM) stand for the sampling month. The next two characters (YY) of the data set name are the last two digits of the sampling year. The last three characters of data set name (DDD) stand for sample collection type. The following types are available for this project:

DATA TYPE	DATA DESCRIPTION
FLD	Field Data
LAB	Laboratory Data
CHL	Chlorophyll Data

Example of Mainstem Data Set Name: For field data sheets for January 1998 data, the data set name is 'JAN98FLD'.

2. MARYLAND TRIBUTARY MONITORING PROJECT

Data Set Name: TMMMYDD

Description: The data set name begins with the project initial 'T', followed by the data sampling month (MMM), year (YY), and data type (DD). The last two characters of the data set name (DD) stand for data type. The following types are available for this project:

DATA TYPE	DATA DESCRIPTION
FD	Field Data
LB	Laboratory Data
CH	Chlorophyll Data

Example of a Tributary Data Set Name: For field data sheets for January 1998 data, the data set name is 'TJAN98FD'.

3. MARYLAND PATUXENT RIVER INTENSIVE SURVEY (PART OF MARYLAND TRIBUTARY MONITORING PROJECT)

Data Set Name: PTMMMYDD

Description: The data set name begins with the project initials 'PT', followed by the data sampling month (MMM), year (YY), and data type (D). The last character of data set name (D) stands for data type. The following types are available for this project:

DATA TYPE DATA DESCRIPTION

- F Field Data
- L Laboratory Data

[Note: Chlorophyll data for the Patuxent is included in the tributary data set.]

Example of a Patuxent Data Set Name: For field data sheets for January 1998 data, the data set name is 'PTJAN98F'.

Example of Monitoring Data Status Form

MARYLAND DEPARTMENT OF NATURAL RESOURCES DATA STATUS FORM		Control No.: <u>0002</u>			
* D.M. function ** D.M. verify only		Date Initiated: <u>2/22/06</u>			
* Data Set Name: <u>FEBO6FLD</u>					
		Project Dates		Initials	Comments
*	Data Received	<u>2/22/06</u>		<u>RVR</u>	
*	Data Reviewed	<u>2/22/06</u>		<u>RVR</u>	
**	Cross Reference				
*	Xeroxing Field sheets				
**	Data Entry				
	Field/Lab/	<u>3/16/06</u>		<u>RVR</u>	
	Patuxent	<u>3/23/06</u>		<u>RVR</u>	
*	Initial Data Check				
*	Data Verification				
*	Temporary Merge(s)				
		Check Records (Date/Initial)			
		1	2	3	4
B	Verification(s)				
I	* Edit(s) Identified				
O	* Data Correction(s)				
C	* Temporary Merge(s)				
H	Biologist Sign Off				
E	* Final Data Correction				
C	* Merge Completed				
C	* Generate FLC Data Set				
K	* Generate EPA FLC Data				
	* Submission Document				
	* Submission Letter				
	Final Sign Off				
	Submission to CBP				
	CBP Data Check List(s)				
	CBP Accepts / Signoff				

APPENDIX X

MARYLAND DEPARTMENT OF NATURAL RESOURCES CHESAPEAKE BAY WATER QUALITY MONITORING PROGRAM

OUTLINE OF CODES FOR FIELD AND LABORATORY DATA SHEETS

This file contains the computer codes for water quality data that will be used for field and laboratory data sheets. The computer codes are listed with their corresponding descriptions.

OUTLINE OF CODES

FIELD DATA SHEETS

- Submitter Codes
- Data Category Codes
- Study Codes
- Sample Method Codes
- Tide State Codes
- Weather Codes
- Percentage Cloud Cover Codes
- Dissolved Oxygen Method Codes
- 'Value Corrected' Codes
- Sample Layer Codes
- Wind Direction Codes

LABORATORY DATA SHEETS

COMPUTER CODES FOR NUTRIENT PARAMETER ANALYSES SHEET

- Submitter Codes
- Data Category Codes
- Sample Method Codes
- Sample Layer Codes
- Study Codes
- Parameter Codes
- Analytical Problem Codes
- Detection Limit Codes
- Method Codes

COMPUTER CODES FOR CHLOROPHYLL PARAMETER ANALYSES SHEET

- Submitter Codes
- Data Category Codes
- Sample Layer Codes
- Study Codes
- Analytical Problem Codes

DETAILED DESCRIPTION OF CODES

BECAUSE THE NEW DATA BASE SYSTEM IS DEVELOPING AND WILL REPLACE THE CURRENT DATA BASE SYSTEM IN THE NEAR FUTURE, MOST OF CURRENT COMPUTER CODES WILL BE DROPPED AFTER THE COMPLETION OF NEW DATA BASE SYSTEM. THE FOLLOWING CODES LIST THE MOST COMMON USED COMPUTER CODES ONLY.

FIELD DATA SHEETS

Submitter Codes:

CODE	DATA COLLECTION AGENCY	ANALYTICAL LAB
28	CBL/FIELD	CHEMICAL – CBL/LAB CHLOROPHYLL – DHMH through 12/31/2008 TURBIDITY - DHMH
60	DNR/TEA	CHEMICAL – CBL, DHMH or WESTERN MD LAB CHLOROPHYLL – DHMH through 12/31/2008 CHLOROPHYLL – CBL beginning 1/1/2009
79	DNR/TEA	CHEMICAL – CBL CHLOROPHYLL – DHMH through 12/31/2008 CHLOROPHYLL – CBL beginning 1/1/2009

Data Category Codes: These codes are designed to indicate the type of data collected

CODE	DESCRIPTION
AA	PRIMARY MONITORING SAMPLE - LAND
AB	PRIMARY MONITORING SAMPLE – BOAT
IN	WATER QUALITY INTENSIVE SURVEY DATA
NR	NON-POINT SOURCE/RUN-OFF SAMPLING DATA
MB	CHESAPEAKE BAY MONITORING WATER QUALITY SAMPLE -- MAIN BAY
MN	AUTOMATED MONITORING STUDY
MT	CHESAPEAKE BAY MONITORING WATER QUALITY SAMPLE -- MARYLAND TRIBUTARY
ST	SEDIMENT DATA SAMPLE
WQ	WATER QUALITY SAMPLE, UNSPECIFIED PROGRAM

Study Codes

CODE	DESCRIPTION	LAB DETAILS
01	CHESAPEAKE BAY MONITORING PROGRAM – MAIN BAY	CHEMICAL – CBL CHLOROPHYLL – DHMH through 12/31/2008 CHLOROPHYLL – CBL beginning 1/1/2009
02	CHESAPEAKE BAY MONITORING PROGRAM – TRIBUTARY (includes PATUXENT)	CHEMICAL (PATUXENT) – DHMH through 6/1990 CHEMICAL (PATUXENT) – CBL beginning 7/1990 CHEMICAL (NON-PATUXENT) – DHMH through 4/1998 CHEMICAL (NON-PATUXENT) – CBL beginning 5/1998 CHLOROPHYLL – DHMH through 12/31/2008 CHLOROPHYLL – CBL beginning 1/1/2009
04	CORE/TREND MONITORING PROGRAM	CHEMICAL – DHMH (Whole Water) Through 6/2005 CHEMICAL – DHMH (Filtered Water) beginning 7/2005 CHLOROPHYLL – DHMH through 12/31/2008 CHLOROPHYLL – CBL beginning 1/1/2009
06	POTOMAC COORDINATED MONITORING PROGRAM - COG	CHEMICAL Tidal – DHMH through 4/1998 CHEMICAL Tidal – CBL beginning 5/1998 CHEMICAL Freshwater – DHMH (Whole Water) Through 6/2005 CHEMICAL Freshwater – DHMH (Filtered Water) beginning 7/2005 CHLOROPHYLL – DHMH through 12/31/2008 CHLOROPHYLL – CBL beginning 1/1/2009
08	COASTAL BAYS PROGRAM	CHEMICAL – CBL CHLOROPHYLL – DHMH through 12/31/2008 CHLOROPHYLL – CBL beginning 1/1/2009
09	ROUTINE FISH WATER QUALITY	CHEMICAL – CBL CHLOROPHYLL – DHMH through 12/31/2008 (last samples collected in 2002)
21	WATER QUALITY MAPPING (DATAFLOW)	CHEMICAL – CBL CHLOROPHYLL – DHMH through 12/31/2008 CHLOROPHYLL – CBL beginning 1/1/2009
22	CONTINUOUS MONITORING	CHEMICAL – CBL CHLOROPHYLL – DHMH through 12/31/2008 CHLOROPHYLL – CBL beginning 1/1/2009
97	ROUTINE PFIESTERIA WATER QUALITY	CHEMICAL – CBL CHLOROPHYLL – DHMH through 12/31/2008 (last samples collected in 2002)
99	RAPID RESPONSE PFIESTERIA WATER QUALITY	CHEMICAL – CBL CHLOROPHYLL – DHMH through 12/31/2008 (last samples collected in 2002)

Sample Method Codes

CODE	DESCRIPTION
1	GRAB SAMPLE
7	FIELD MEASUREMENTS ONLY

Tide State Codes

CODE	DESCRIPTION	COMMENT
E	EBB TIDE	STAGE OF WATER MOVEMENT FROM A HIGHER TO A LOWER LEVEL.
F	FLOOD TIDE	STAGE OF WATER MOVEMENT FROM A LOWER TO A HIGHER LEVEL.
L	LOWER SLACK TIDE	STAGE OF WATER WHERE THE LEVEL IS BELOW MEAN AND VELOCITY APPROACHES ZERO
H	HIGH SLACK TIDE	STAGE OF WATER WHERE THE LEVEL IS ABOVE MEAN AND VELOCITY APPROACHES ZERO
BLANK	NOT RECORDED	NOT APPLICABLE

Weather Codes

CODE	DESCRIPTION
10	NONE
11	DRIZZLE
12	RAIN
13	HEAVY RAIN
14	SQUALLY
15	FROZEN PRECIPITATION
16	MIXED RAIN AND SNOW
BLANK	NOT RECORDED, OR NOT APPLICABLE

Percentage Cloud Cover Codes

PERCENTAGE CLOUD COVER IS REPORTED AS VALUES FROM 0 –100 %

Dissolved Oxygen Method Codes

CODE	DESCRIPTION
W	WINKLER METHOD
M	YSI METER
H	HYDROLAB
BLANK	NOT RECORDED, OR NOT APPLICABLE

'Value Corrected' Codes: These codes are designed to specify if corrections have been made by the instrument calculation for the dissolved oxygen value.

CODE	DESCRIPTION
N	NO CORRECTION
T	TEMPERATURE CORRECTION ONLY
C	TEMPERATURE AND CONDUCTIVITY CORRECTION

Sample Layer Codes

CODE	DESCRIPTION
S	SURFACE SAMPLE
AP	ABOVE PYCNOCLINE
BP	BELOW PYCNOCLINE
B	BOTTOM SAMPLE
M	MID-DEPTH SAMPLE
BLANK	NOT RECORDED, OR NOT APPLICABLE

Wind Direction Codes

CODE	DESCRIPTION
E	FROM THE EAST (90 DEGREES)
ENE	FROM THE EAST NORTHEAST (67.5 DEGREES)
ESE	FROM THE EAST SOUTHEAST (112.5 DEGREES)
N	FROM THE NORTH (0 DEGREES)
NE	FROM THE NORTHEAST (45 DEGREES)
NNE	FROM THE NORTH NORTHEAST (22.5 DEGREES)
NNW	FROM THE NORTH NORTHWEST (337.5 DEGREES)
NW	FROM THE NORTHWEST (315 DEGREES)
S	FROM THE SOUTH (180 DEGREES)
SE	FROM THE SOUTHEAST (135 DEGREES)
SSE	FROM THE SOUTH SOUTHEAST (157.5 DEGREES)
SSW	FROM THE SOUTH SOUTHWEST (202.5 DEGREES)
SW	FROM THE SOUTHWEST (225 DEGREES)
W	FROM THE WEST (270 DEGREES)
WNW	FROM THE WEST NORTHWEST (292.5 DEGREES)
WSW	FROM THE WEST SOUTHWEST (247.5 DEGREES)
NR	NOT RECORDED, OR NOT APPLICABLE

LABORATORY DATA SHEETS

COMPUTER CODES FOR NUTRIENT PARAMETER ANALYSES SHEET

Submitter Codes: The codes are the same as for field data sheets

Data Category Codes: The codes are the same as for field data sheets

Sample Method Codes: The codes are the same as for field data sheets

Sample Layer Codes: The codes are the same as for field data sheets

Study Codes: The codes are the same as for field data sheets

Parameter Codes:

CODE	DESCRIPTION	UNIT
BIOSI	PARTICULATE BIOGENIC SILICA	mg/L
BOD5W	FIVE DAY BIOLOGICAL OXYGEN DEMAND	mg/L
CHLA	ACTIVE CHLOROPHYLL A	µg/L
DOC	DISSOLVED ORGANIC CARBON AS C	mg/L
DON	DISSOLVED ORGANIC NITROGEN AS N	mg/L
DOP	DISSOLVED ORGANIC PHOSPHORUS AS P	mg/L
TDS	DISSOLVED SOLIDS if on filtered water sample	mg/L
FCOL_M	FECAL COLIFORM	MPN/100ml
FE_M	TOTAL IRON	mg/L
NH4F	AMMONIA AS N (FILTERED)	mg/L
NH4W	AMMONIA AS N (WHOLE)	mg/L
NO2F	NITRITE AS N (FILTERED)	mg/L
NO2W	NITRITE AS N (WHOLE)	mg/L
NO23F	NITRITE + NITRATE AS N (FILTERED)	mg/L
NO23W	NITRITE + NITRATE AS N (WHOLE)	mg/L
NO3F	NITRATE AS N (FILTERED)	mg/L
NO3W	NITRATE AS N (WHOLE)	mg/L
PC	PARTICULATE ORGANIC CARBON AS C	mg/L
PHEO	MONOCHROMATIC PHEOPHYTIN A	µg/L
PIP	PARTICULATE INORGANIC PHOSPHORUS	mg/L
PN	PARTICULATE ORGANIC NITROGEN AS N	mg/L
PO4F	DISSOLVED ORTHOPHOSPHATE AS P (FILTERED)	mg/L
PO4W	DISSOLVED ORTHOPHOSPHATE AS P (WHOLE)	mg/L
PP	PARTICULATE PHOSPHORUS AS P	mg/L
SIF	REACTIVE SILICA AS SI (FILTERED)	mg/L
SIW	REACTIVE SILICA AS SI (WHOLE)	mg/L
SO4F	SULFATE (FILTERED)	mg/L
SO4W	SULFATE (WHOLE)	mg/L
TALK	TOTAL ALKALINITY	mg/L
TCOLI_M	TOTAL COLIFORM	MPN/100ml
TDN	TOTAL DISSOLVED NITROGEN AS N (FILTERED)	mg/L
TDP	TOTAL DISSOLVED PHOSPHORUS AS P (FILTERED)	mg/L
TKNF	TOTAL KJELDAHL NITROGEN AS N (FILTERED)	mg/L
TKNW	TOTAL KJELDAHL NITROGEN AS N (WHOLE)	mg/L
TN	TOTAL NITROGEN	mg/L
TOC	TOTAL ORGANIC CARBON	mg/L
TP	TOTAL PHOSPHORUS	mg/L
TSS	TOTAL SUSPENDED SOLIDS	mg/L
TURB_NTU	TURBIDITY	NTU

Analytical Problem Codes (APC):

TEA Maryland Department of Natural Resources Tidal Ecosystem Assessment
CBP Environmental Protection Agency Chesapeake Bay Program Office
CBL University Of Maryland Center for Environmental Science, Chesapeake Biological Laboratory, Nutrient Analytical Services Laboratory
DHMH Maryland Department of Health and Mental Hygiene

TEA Problem Code	CBP Problem Code	CBL Problem Code	Description
A	A	1	LABORATORY ACCIDENT
	AA		FIELD ACCIDENT
B	B		CHEMICAL MATRIX INTERFERENCE
BB	BB	19	TORN FILTER PAD
C	C	12	INSTRUMENT FAILURE
CC			PAD UNFOLDED IN FOIL POUCH
D	D	2	INSUFFICIENT SAMPLE
DD	DD	15	SAMPLE SIZE NOT REPORTED (ASSUMED)
DM			LAB SAMPLE DEPTH MISMATCH WITH FIELD SAMPLE DEPTH
E	E		SAMPLE RECEIVED AFTER HOLDING TIME
EE			FOIL POUCH VERY WET (SALTY) WHEN RECEIVED FROM FIELD; MEAN REPORTED
F	F		POST-CALIBRATION FAILURE LIKELY DUE TO EQUIPMENT DAMAGE AFTER SAMPLING; DATA APPEAR NORMAL
FF	FF	14	POOR REPLICATION BETWEEN PADS, MEAN REPORTED
GG	GG		SAMPLE ANALYZED AFTER HOLDING TIME
H	H	3	ANALYSIS RUN BY ANOTHER LAB
	I		SUSPECT VALUE HAS BEEN VERIFIED CORRECT
J	J		INCORRECT SAMPLE FRACTION FOR ANALYSIS
JJ	JJ		VOLUME FILTERED NOT RECORDED (ASSUMED)
K		4	SAMPLE FROZEN WHEN RECEIVED (RESULT QUESTIONABLE)
KK	KK		PARAMETER NOT REQUIRED FOR STUDY
	L		LICOR CALIBRATION OFF BY >=10% PER YEAR. USE WITH CALC KD WHERE PROB OF LU, LS, LB EXIST IN RAW
	LB		LICOR CALIBRATION OFF BY >= 10% PER YEAR FOR BOTH AIR AND UPWARD FACING SENSORS
LL		16	SAMPLE MISLABELED

Analytical Problem Codes (APC) continued:

TEA Problem Code	CBP Problem Code	CBL Problem Code	Description
	LS		LICOR CALIBRATION OFF BY >= 10% PER YEAR FOR AIR SENSOR
	LU		LICOR CALIBRATION OFF BY >= 10% PER YEAR FOR UPWARD FACING SENSOR
M	X	5	SAMPLE RECEIVED WARM
MM	MM	17	OVER 20% OF SAMPLE ADHERED TO POUCH AND OUTSIDE OF PAD
N		6	SAMPLE LOST
NN	NN	21	PARTICULATES FOUND IN FILTERED SAMPLE
	P		PROVISIONAL DATA
P		7	LOST RESULTS
PP	DD	22	ASSUMED SAMPLE VOLUME
QQ	QQ	23	PART EXCEEDS WHOLE VALUE, YET DIFFERENCE IS WITHIN ANALYTICAL PRECISION
R	R	8	SAMPLE CONTAMINATED
RR	RR	18	NO SAMPLE RECEIVED
S	A		SAMPLE CONTAINER BROKEN DURING ANALYSIS
T			NO PHEOPHYTIN IN SAMPLE
U	U		MATRIX PROBLEM RESULTING OF THE INTERRELATIONSHIP BETWEEN VARIABLES SUCH AS PH AND AMMONIA
UU	V		ANALYSIS DISCONTINUED
V	V	9	SAMPLE RESULTS REJECTED DUE TO QUALITY CONTROL CRITERIA
VV	VV		STATION NOT SAMPLED DUE TO BAD FIELD CONDITIONS
W	RR		DUPLICATE RESULTS FOR ALL PARAMETERS
WW	WW		HIGH OPTICAL DENSITY (750 NM); ACTUAL VALUE REPORTED

Analytical Problem Codes (APC) continued:

TEA Problem Code	CBP Problem Code	CBL Problem Code	Description
X	X	10	SAMPLE NOT PRESERVED PROPERLY
XX			SAMPLING FOR THIS VARIABLE NOT INCLUDED IN THE MONITORING PROGRAM AT THIS TIME
Y		11	ANALYZED IN DUPLICATE, RESULTS BELOW DETECTION LIMIT
Z			ANALYZED BY METHOD OF STANDARD ADDITIONS

Detection Limit Codes:

CODE	DESCRIPTION
BLANK	NORMAL
G	GREATER THAN THE UPPER METHOD DETECTION LIMIT (MDL)
L	LESS THAN THE LOWER METHOD DETECTION LIMIT (MDL) AND STORED LOWER DETECTION LIMIT
U	VALUE LESS THAN LOWER METHOD DETECTION LIMIT (MDL) AND STORED IN REAL VALUE

Method Codes:

CODE	METHOD TITLE	UNIT	METHOD
BOD5W	5-DAY BIOCHEMICAL OXYGEN DEMAND	mg/L	L01
CHLA	MONOCHROMATIC; SPECTROPHOTOMETRIC	µg/L	L01
DOC	COMBUSTION INFRARED METHOD	mg/L	L01
FE_M	TOTAL IRON; PHENANTHROLINE METHOD	mg/L	L01
NH4F	COLORIMETRIC; AUTOMATED PHENATE (INDOPHENOL)	mg/L	L01
NO23F	ENZYME CATALYZED NITRATE REDUCTION	mg/L	L03
NO2F	AUTOMATED; COLORIMETRIC; DIAZOTIZATION	mg/L	L01
NO3F	CALCULATED NO3F (SUBMITTED TO CBPO)	mg/L	C01
PC	PARTICULATE CARBON	mg/L	L01
PHEO	MONOCHROMATIC; SPECTROPHOTOMETRIC	µg/L	L01
PN	PARTICULATE NITROGEN	mg/L	L01
PO4F	ORTHOPHOSPHATE; AUTOMATED; ASCORBIC ACID	mg/L	L01
PP	PARTICULATE PHOSPHORUS; SEMI-AUTOMATED; DIRECT	mg/L	L01
SIF	COLORIMETRIC; AUTOMATED; MOLYBDENUM BLUE	mg/L	L01
SO4F	SULFATE; TURBIDIMETRIC METHOD	mg/L	L01

Method Codes continued:

TALK	ALKALINITY; TITRIMETRIC; pH 4.5	mg/L	L01
TDN	ALKALINE PERSULFATE WET OXIDATION + ENZYME CATALYZED NITRATE REDUCTION	mg/L	L02
TDP	ALKALINE PERSULFATE WET OXIDATION + EPA365.1OR EPA 365	mg/L	L01
TDS	TOT. DISSOLVED SOLIDS; GRAVIMETRIC; DRIED AT 180 C	mg/L	L01
TKNF	SEMI-AUTOMATED BLOCK DIGESTOR; COLORIMETRIC; NITRO	mg/L	L02
TKNW	SEMI-AUTOMATED BLOCK DIGESTOR; COLORIMETRIC; NITRO	mg/L	L02
TSS	GRAVIMETRIC; DRIED AT 103-105 C	mg/L	L01
TURB_NTU	NEPHELOMETRIC	NTU	L01

COMPUTER CODES FOR CHLOROPHYLL PARAMETER ANALYSIS SHEET

Submitter Codes: The codes are the same as field data sheets

Data Category Codes: The codes are the same as field data sheets

Sample Layer Codes: The codes are the same as field data sheets

Study Codes: The codes are the same as field data sheets

Analytical Problem Codes: The codes are the same as laboratory data sheets

APPENDIX XI

MARYLAND DEPARTMENT OF NATURAL RESOURCES CHESAPEAKE BAY WATER QUALITY MONITORING PROGRAM

OUTLINE OF CODES FOR FIELD AND LABORATORY DATA SHEETS

This file contains the computer codes for water quality data that will be used for field and laboratory data sheets. The computer codes are listed with their corresponding descriptions.

OUTLINE OF CODES

FIELD DATA SHEETS

- Submitter Codes
- Data Category Codes
- Study Codes
- Sample Method Codes
- Tide State Codes
- Weather Codes
- Percentage Cloud Cover Codes
- Dissolved Oxygen Method Codes
- 'Value Corrected' Codes
- Sample Layer Codes
- Wind Direction Codes

LABORATORY DATA SHEETS

COMPUTER CODES FOR NUTRIENT PARAMETER ANALYSES SHEET

- Submitter Codes
- Data Category Codes
- Sample Method Codes
- Sample Layer Codes
- Study Codes
- Parameter Codes
- Analytical Problem Codes
- Detection Limit Codes
- Method Codes

COMPUTER CODES FOR CHLOROPHYLL PARAMETER ANALYSES SHEET

- Submitter Codes
- Data Category Codes
- Sample Layer Codes
- Study Codes
- Analytical Problem Codes

DETAILED DESCRIPTION OF CODES

BECAUSE THE NEW DATA BASE SYSTEM IS DEVELOPING AND WILL REPLACE THE CURRENT DATA BASE SYSTEM IN THE NEAR FUTURE, MOST OF CURRENT COMPUTER CODES WILL BE DROPPED AFTER THE COMPLETION OF NEW DATA BASE SYSTEM. THE FOLLOWING CODES LIST THE MOST COMMON USED COMPUTER CODES ONLY.

FIELD DATA SHEETS

Submitter Codes:

CODE	DATA COLLECTION AGENCY	ANALYTICAL LAB
28	CBL/FIELD	CHEMICAL – CBL/LAB CHLOROPHYLL – DHMH through 12/31/2008 TURBIDITY - DHMH
60	DNR/TEA	CHEMICAL – CBL, DHMH or WESTERN MD LAB CHLOROPHYLL – DHMH through 12/31/2008 CHLOROPHYLL – CBL beginning 1/1/2009
79	DNR/TEA	CHEMICAL – CBL CHLOROPHYLL – DHMH through 12/31/2008 CHLOROPHYLL – CBL beginning 1/1/2009

Data Category Codes: These codes are designed to indicate the type of data collected

CODE	DESCRIPTION
AA	PRIMARY MONITORING SAMPLE - LAND
AB	PRIMARY MONITORING SAMPLE – BOAT
IN	WATER QUALITY INTENSIVE SURVEY DATA
NR	NON-POINT SOURCE/RUN-OFF SAMPLING DATA
MB	CHESAPEAKE BAY MONITORING WATER QUALITY SAMPLE -- MAIN BAY
MN	AUTOMATED MONITORING STUDY
MT	CHESAPEAKE BAY MONITORING WATER QUALITY SAMPLE -- MARYLAND TRIBUTARY
ST	SEDIMENT DATA SAMPLE
WQ	WATER QUALITY SAMPLE, UNSPECIFIED PROGRAM

Study Codes

CODE	DESCRIPTION	LAB DETAILS
01	CHESAPEAKE BAY MONITORING PROGRAM – MAIN BAY	CHEMICAL – CBL CHLOROPHYLL – DHMH through 12/31/2008 CHLOROPHYLL – CBL beginning 1/1/2009
02	CHESAPEAKE BAY MONITORING PROGRAM – TRIBUTARY (includes PATUXENT)	CHEMICAL (PATUXENT) – DHMH through 6/1990 CHEMICAL (PATUXENT) – CBL beginning 7/1990 CHEMICAL (NON-PATUXENT) – DHMH through 4/1998 CHEMICAL (NON-PATUXENT) – CBL beginning 5/1998 CHLOROPHYLL – DHMH through 12/31/2008 CHLOROPHYLL – CBL beginning 1/1/2009
04	CORE/TREND MONITORING PROGRAM	CHEMICAL – DHMH (Whole Water) Through 6/2005 CHEMICAL – DHMH (Filtered Water) beginning 7/2005 CHLOROPHYLL – DHMH through 12/31/2008 CHLOROPHYLL – CBL beginning 1/1/2009
06	POTOMAC COORDINATED MONITORING PROGRAM - COG	CHEMICAL Tidal – DHMH through 4/1998 CHEMICAL Tidal – CBL beginning 5/1998 CHEMICAL Freshwater – DHMH (Whole Water) Through 6/2005 CHEMICAL Freshwater – DHMH (Filtered Water) beginning 7/2005 CHLOROPHYLL – DHMH through 12/31/2008 CHLOROPHYLL – CBL beginning 1/1/2009
08	COASTAL BAYS PROGRAM	CHEMICAL – CBL CHLOROPHYLL – DHMH through 12/31/2008 CHLOROPHYLL – CBL beginning 1/1/2009
09	ROUTINE FISH WATER QUALITY	CHEMICAL – CBL CHLOROPHYLL – DHMH through 12/31/2008 (last samples collected in 2002)
21	WATER QUALITY MAPPING (DATAFLOW)	CHEMICAL – CBL CHLOROPHYLL – DHMH through 12/31/2008 CHLOROPHYLL – CBL beginning 1/1/2009
22	CONTINUOUS MONITORING	CHEMICAL – CBL CHLOROPHYLL – DHMH through 12/31/2008 CHLOROPHYLL – CBL beginning 1/1/2009
97	ROUTINE PFIESTERIA WATER QUALITY	CHEMICAL – CBL CHLOROPHYLL – DHMH through 12/31/2008 (last samples collected in 2002)
99	RAPID RESPONSE PFIESTERIA WATER QUALITY	CHEMICAL – CBL CHLOROPHYLL – DHMH through 12/31/2008 (last samples collected in 2002)

Sample Method Codes

CODE	DESCRIPTION
1	GRAB SAMPLE
7	FIELD MEASUREMENTS ONLY

Tide State Codes

CODE	DESCRIPTION	COMMENT
E	EBB TIDE	STAGE OF WATER MOVEMENT FROM A HIGHER TO A LOWER LEVEL.
F	FLOOD TIDE	STAGE OF WATER MOVEMENT FROM A LOWER TO A HIGHER LEVEL.
L	LOWER SLACK TIDE	STAGE OF WATER WHERE THE LEVEL IS BELOW MEAN AND VELOCITY APPROACHES ZERO
H	HIGH SLACK TIDE	STAGE OF WATER WHERE THE LEVEL IS ABOVE MEAN AND VELOCITY APPROACHES ZERO
BLANK	NOT RECORDED	NOT APPLICABLE

Weather Codes

CODE	DESCRIPTION
10	NONE
11	DRIZZLE
12	RAIN
13	HEAVY RAIN
14	SQUALLY
15	FROZEN PRECIPITATION
16	MIXED RAIN AND SNOW
BLANK	NOT RECORDED, OR NOT APPLICABLE

Percentage Cloud Cover Codes

PERCENTAGE CLOUD COVER IS REPORTED AS VALUES FROM 0 –100 %

Dissolved Oxygen Method Codes

CODE	DESCRIPTION
W	WINKLER METHOD
M	YSI METER
H	HYDROLAB
BLANK	NOT RECORDED, OR NOT APPLICABLE

'Value Corrected' Codes: These codes are designed to specify if corrections have been made by the instrument calculation for the dissolved oxygen value.

CODE	DESCRIPTION
N	NO CORRECTION
T	TEMPERATURE CORRECTION ONLY
C	TEMPERATURE AND CONDUCTIVITY CORRECTION

Sample Layer Codes

CODE	DESCRIPTION
S	SURFACE SAMPLE
AP	ABOVE PYCNOCLINE
BP	BELOW PYCNOCLINE
B	BOTTOM SAMPLE
M	MID-DEPTH SAMPLE
BLANK	NOT RECORDED, OR NOT APPLICABLE

Wind Direction Codes

CODE	DESCRIPTION
E	FROM THE EAST (90 DEGREES)
ENE	FROM THE EAST NORTHEAST (67.5 DEGREES)
ESE	FROM THE EAST SOUTHEAST (112.5 DEGREES)
N	FROM THE NORTH (0 DEGREES)
NE	FROM THE NORTHEAST (45 DEGREES)
NNE	FROM THE NORTH NORTHEAST (22.5 DEGREES)
NNW	FROM THE NORTH NORTHWEST (337.5 DEGREES)
NW	FROM THE NORTHWEST (315 DEGREES)
S	FROM THE SOUTH (180 DEGREES)
SE	FROM THE SOUTHEAST (135 DEGREES)
SSE	FROM THE SOUTH SOUTHEAST (157.5 DEGREES)
SSW	FROM THE SOUTH SOUTHWEST (202.5 DEGREES)
SW	FROM THE SOUTHWEST (225 DEGREES)
W	FROM THE WEST (270 DEGREES)
WNW	FROM THE WEST NORTHWEST (292.5 DEGREES)
WSW	FROM THE WEST SOUTHWEST (247.5 DEGREES)
NR	NOT RECORDED, OR NOT APPLICABLE

LABORATORY DATA SHEETS

COMPUTER CODES FOR NUTRIENT PARAMETER ANALYSES SHEET

Submitter Codes: The codes are the same as for field data sheets

Data Category Codes: The codes are the same as for field data sheets

Sample Method Codes: The codes are the same as for field data sheets

Sample Layer Codes: The codes are the same as for field data sheets

Study Codes: The codes are the same as for field data sheets

Parameter Codes:

CODE	DESCRIPTION	UNIT
BIOSI	PARTICULATE BIOGENIC SILICA	mg/L
BOD5W	FIVE DAY BIOLOGICAL OXYGEN DEMAND	mg/L
CHLA	ACTIVE CHLOROPHYLL A	µg/L
DOC	DISSOLVED ORGANIC CARBON AS C	mg/L
DON	DISSOLVED ORGANIC NITROGEN AS N	mg/L
DOP	DISSOLVED ORGANIC PHOSPHORUS AS P	mg/L
TDS	DISSOLVED SOLIDS if on filtered water sample	mg/L
FCOL_M	FECAL COLIFORM	MPN/100ml
FE_M	TOTAL IRON	mg/L
NH4F	AMMONIA AS N (FILTERED)	mg/L
NH4W	AMMONIA AS N (WHOLE)	mg/L
NO2F	NITRITE AS N (FILTERED)	mg/L
NO2W	NITRITE AS N (WHOLE)	mg/L
NO23F	NITRITE + NITRATE AS N (FILTERED)	mg/L
NO23W	NITRITE + NITRATE AS N (WHOLE)	mg/L
NO3F	NITRATE AS N (FILTERED)	mg/L
NO3W	NITRATE AS N (WHOLE)	mg/L
PC	PARTICULATE ORGANIC CARBON AS C	mg/L
PHEO	MONOCHROMATIC PHEOPHYTIN A	µg/L
PIP	PARTICULATE INORGANIC PHOSPHORUS	mg/L
PN	PARTICULATE ORGANIC NITROGEN AS N	mg/L
PO4F	DISSOLVED ORTHOPHOSPHATE AS P (FILTERED)	mg/L
PO4W	DISSOLVED ORTHOPHOSPHATE AS P (WHOLE)	mg/L
PP	PARTICULATE PHOSPHORUS AS P	mg/L
SIF	REACTIVE SILICA AS SI (FILTERED)	mg/L
SIW	REACTIVE SILICA AS SI (WHOLE)	mg/L
SO4F	SULFATE (FILTERED)	mg/L
SO4W	SULFATE (WHOLE)	mg/L
TALK	TOTAL ALKALINITY	mg/L
TCOLI_M	TOTAL COLIFORM	MPN/100ml
TDN	TOTAL DISSOLVED NITROGEN AS N (FILTERED)	mg/L
TDP	TOTAL DISSOLVED PHOSPHORUS AS P (FILTERED)	mg/L
TKNF	TOTAL KJELDAHL NITROGEN AS N (FILTERED)	mg/L
TKNW	TOTAL KJELDAHL NITROGEN AS N (WHOLE)	mg/L
TN	TOTAL NITROGEN	mg/L
TOC	TOTAL ORGANIC CARBON	mg/L
TP	TOTAL PHOSPHORUS	mg/L
TSS	TOTAL SUSPENDED SOLIDS	mg/L
TURB_NTU	TURBIDITY	NTU

Analytical Problem Codes (APC):

TEA Maryland Department of Natural Resources Tidal Ecosystem Assessment
CBP Environmental Protection Agency Chesapeake Bay Program Office
CBL University Of Maryland Center for Environmental Science, Chesapeake Biological Laboratory, Nutrient Analytical Services Laboratory
DHMH Maryland Department of Health and Mental Hygiene

TEA Problem Code	CBP Problem Code	CBL Problem Code	Description
A	A	1	LABORATORY ACCIDENT
B	B		CHEMICAL MATRIX INTERFERENCE
BB	BB	19	TORN FILTER PAD
C	C	12	INSTRUMENT FAILURE
CC			PAD UNFOLDED IN FOIL POUCH
D	D	2	INSUFFICIENT SAMPLE
DD	DD	15	SAMPLE SIZE NOT REPORTED (ASSUMED)
DM	V		LAB SAMPLE DEPTH MISMATCH WITH FIELD SAMPLE DEPTH
E	E		SAMPLE RECEIVED AFTER HOLDING TIME
EE			FOIL POUCH VERY WET (SALTY) WHEN RECEIVED FROM FIELD; MEAN REPORTED
F	F		POST-CALIBRATION FAILURE LIKELY DUE TO EQUIPMENT DAMAGE AFTER SAMPLING; DATA APPEAR NORMAL
FF	FF	14	POOR REPLICATION BETWEEN PADS, MEAN REPORTED
GG	GG		SAMPLE ANALYZED AFTER HOLDING TIME
H	H	3	ANALYSIS RUN BY ANOTHER LAB
	I		SUSPECT VALUE HAS BEEN VERIFIED CORRECT
J	J		INCORRECT SAMPLE FRACTION FOR ANALYSIS
JJ	JJ		VOLUME FILTERED NOT RECORDED (ASSUMED)
K	X	4	SAMPLE FROZEN WHEN RECEIVED (RESULT QUESTIONABLE)
KK	KK		PARAMETER NOT REQUIRED FOR STUDY
	L		LICOR CALIBRATION OFF BY >=10% PER YEAR. USE WITH CALC KD WHERE PROB OF LU, LS, LB EXIST IN RAW
	LB		LICOR CALIBRATION OFF BY >= 10% PER YEAR FOR BOTH AIR AND UPWARD FACING SENSORS
LL	LL	16	SAMPLE MISLABELED

Analytical Problem Codes (APC) continued next page:

Analytical Problem Codes (APC) continued:

TEA Problem Code	CBP Problem Code	CBL Problem Code	Description
	LS		LICOR CALIBRATION OFF BY >= 10% PER YEAR FOR AIR SENSOR
	LU		LICOR CALIBRATION OFF BY >= 10% PER YEAR FOR UPWARD FACING SENSOR
M	X	5	SAMPLE RECEIVED WARM
MM	MM	17	OVER 20% OF SAMPLE ADHERED TO POUCH AND OUTSIDE OF PAD
N		6	SAMPLE LOST
NN	NN	21	PARTICULATES FOUND IN FILTERED SAMPLE
P	A	7	LOST RESULTS
PP	D	22	ASSUMED SAMPLE VOLUME
QQ	QQ	23	PART EXCEEDS WHOLE VALUE, YET DIFFERENCE IS WITHIN ANALYTICAL PRECISION
R	R	8	SAMPLE CONTAMINATED
RR	RR	18	NO SAMPLE RECEIVED
S	A		SAMPLE CONTAINER BROKEN DURING ANALYSIS
T	T		NO PHEOPHYTIN IN SAMPLE
U	U		MATRIX PROBLEM RESULTING OF THE INTERRELATIONSHIP BETWEEN VARIABLES SUCH AS PH AND AMMONIA
UU	V		ANALYSIS DISCONTINUED
V	V	9	SAMPLE RESULTS REJECTED DUE TO QUALITY CONTROL CRITERIA
VV	VV		STATION NOT SAMPLED DUE TO BAD FIELD CONDITIONS
W	RR		DUPLICATE RESULTS FOR ALL PARAMETERS
WW	WW		HIGH OPTICAL DENSITY (750 NM); ACTUAL VALUE REPORTED

Analytical Problem Codes (APC) continued next page:

Analytical Problem Codes (APC) continued:

TEA Problem Code	CBP Problem Code	CBL Problem Code	Description
X	X	10	SAMPLE NOT PRESERVED PROPERLY
XX	V		SAMPLING FOR THIS VARIABLE NOT INCLUDED IN THE MONITORING PROGRAM AT THIS TIME
Y	V	11	ANALYZED IN DUPLICATE, RESULTS BELOW DETECTION LIMIT
Z	Z		ANALYZED BY METHOD OF STANDARD ADDITIONS

Detection Limit Codes:

CODE	DESCRIPTION
BLANK	NORMAL
G	GREATER THAN THE UPPER METHOD DETECTION LIMIT (MDL)
L	LESS THAN THE LOWER METHOD DETECTION LIMIT (MDL) AND STORED LOWER DETECTION LIMIT
U	VALUE LESS THAN LOWER METHOD DETECTION LIMIT (MDL) AND STORED IN REAL VALUE

Method Codes:

CODE	METHOD TITLE	UNIT	METHOD
BOD5W	5-DAY BIOCHEMICAL OXYGEN DEMAND	mg/L	L01
CHLA	MONOCHROMATIC; SPECTROPHOTOMETRIC	µg/L	L01
DOC	COMBUSTION INFRARED METHOD	mg/L	L01
FE_M	TOTAL IRON; PHENANTHROLINE METHOD	mg/L	L01
NH4F	COLORIMETRIC; AUTOMATED PHENATE (INDOPHENOL)	mg/L	L01
NO23F	ENZYME CATALYZED NITRATE REDUCTION	mg/L	L03

NO2F	AUTOMATED; COLORIMETRIC; DIAZOTIZATION	mg/L	L01
NO3F	CALCULATED NO3F (SUBMITTED TO CBPO)	mg/L	C01
PC	PARTICULATE CARBON	mg/L	L01
PHEO	MONOCHROMATIC; SPECTROPHOTOMETRIC	µg/L	L01
PN	PARTICULATE NITROGEN	mg/L	L01
PO4F	ORTHOPHOSPHATE; AUTOMATED; ASCORBIC ACID	mg/L	L01
PP	PARTICULATE PHOSPHORUS; SEMI-AUTOMATED; DIRECT	mg/L	L01
SIF	COLORIMETRIC; AUTOMATED; MOLYBDENUM BLUE	mg/L	L01
SO4F	SULFATE; TURBIDIMETRIC METHOD	mg/L	L01
TALK	ALKALINITY; TITRIMETRIC; pH 4.5	mg/L	L01
TDN	ALKALINE PERSULFATE WET OXIDATION + ENZYME CATALYZED NITRATE REDUCTION	mg/L	L02
TDP	ALKALINE PERSULFATE WET OXIDATION + EPA365.1OR EPA 365	mg/L	L01
TDS	TOT. DISSOLVED SOLIDS; GRAVIMETRIC; DRIED AT 180 C	mg/L	L01
TKNF	SEMI-AUTOMATED BLOCK DIGESTOR; COLORIMETRIC; NITRO	mg/L	L02
TKNW	SEMI-AUTOMATED BLOCK DIGESTOR; COLORIMETRIC; NITRO	mg/L	L02
TSS	GRAVIMETRIC; DRIED AT 103-105 C	mg/L	L01
TURB_NTU	NEPHELOMETRIC	NTU	L01

COMPUTER CODES FOR CHLOROPHYLL PARAMETER ANALYSIS SHEET

Submitter Codes: The codes are the same as field data sheets

Data Category Codes: The codes are the same as field data sheets

Sample Layer Codes: The codes are the same as field data sheets

Study Codes: The codes are the same as field data sheets

Analytical Problem Codes: The codes are the same as laboratory data sheets

Appendix XII. Sample Verification Reports and Plots and Edit Form

Maryland Department of Natural Resources

Field Sheet

Station Name Project Code Sequence Number

Sample Date Arrival Time Departure Time Sample Number Measured Depth Tide Code Weather Yesterday Weather Today Cloud Cover (%) Wave Height

Wind Direction Wind Min. Velocity Wind Max. Velocity Air Temperature Photometer Unit Number Pycnocline Lower Upper Secchi GL

Equipment Set Unit No. Probe Number

Description:

Parameter List:

Rep	Sample depth	Water Temp	PH	DO	SPCOND	Salinity	Calc. Salinity	Rep. Salinity	Sample depth	Layer Code
1	0.5	5.7	8.2	11.9	21700	13	12.86	1	0.0	S
1	1	5.7	8.2	11.8	21700	13	12.86	1	1	M
1	2	5.7	8.2	11.9	21700	13	12.86	1	2	M
1	3	5.7	8.2	11.8	21700	13	12.86	1	3	M
1	5	5.6	8.3	12	21700	13	12.86	1	5	M
1	7	5.6	8.2	12	21800	13	12.93	1	7	M
1	9	5.6	8.2	11.7	21600	13	12.93	1	9	AP
1	10	5.6	8.2	11.5	21800	13.1	12.93	1	10	M
1	11	5.8	8.1	10.7	24000	14.1	14.4	1	11	M
1	12	6.9	8	9.6	29000	18	18.41	1	12	M
1	13	5.9	7.9	9.6	30000	18.6	18.48	1	13	M
1	14	5.9	8	9.5	30100	18.6	18.55	1	14	M
1	15	5.9	7.9	9.5	30200	18.7	18.62	1	15	M
1	16	5.9	7.9	9.5	30300	18.7	18.69	1	16	M
1	17	5.9	7.9	9.5	30500	18.9	18.83	1	17	M
1	18	6	7.9	9.5	31300	19.4	19.38	1	18	M
1	19	6	8	9.5	31400	19.5	19.45	1	19	BP
1	21	6.1	8	9.5	31000	19.7	19.17	1	21	M

Sample Agency: Sample Officer:

Tuesday, March 28, 2006 Page 1 of 20

Maryland Department of Natural Resources

Chlorophyll Sheet Chl Sequence No
3-460

Project Code Sample Date: 2/7/2006

Parameters:

Station Name	SEQ	Rep #	Layer Code	Sample Depth	EXVOL	APC	LIPAT	SAMVOL	OD630	OD645	OD647	OD663B	OD664B	OD665A	OD750A	OD750	PHEO	CHLA
					_ML	_CODE	CM	_L	B	B	B	B	B	B	B	B		
CBS.2	3-460	1	S	0.5	14		5	0.50	0.038	0.035	0.039	0.135	0.136	0.085	0.005	0.005	000.748	007.626
CBS.2	3-460	2	S	0.5	14		5	0.50	0.037	0.035	0.039	0.132	0.132	0.082	0.005	0.005	000.583	007.476
CBS.3	3-460	1	S	0.5	14		5	0.50	0.056	0.052	0.059	0.210	0.210	0.128	0.006	0.005	000.359	012.410
CBS.3	3-460	1	AP	9	14		5	0.50	0.058	0.054	0.062	0.218	0.218	0.134	0.007	0.007	000.733	012.560
CBS.3	3-460	1	BP	19	14		5	0.40	0.042	0.039	0.045	0.152	0.152	0.098	0.005	0.005	002.075	010.093
CBS.3	3-460	1	B	26	14		5	0.40	0.047	0.045	0.051	0.169	0.169	0.115	0.008	0.006	003.532	010.466
LE2.3	3-460	1	S	0.5	14		5	0.50	0.052	0.048	0.054	0.192	0.192	0.117	0.006	0.006	000.404	011.214
LE2.3	3-460	1	AP	7	14		5	0.50	0.069	0.064	0.073	0.263	0.264	0.160	0.007	0.005	000.164	015.849
LE2.3	3-460	1	BP	13	14		5	0.40	0.059	0.054	0.062	0.227	0.227	0.136	0.005	0.005	000.131	017.008
LE2.3	3-460	1	B	19	14		5	0.40	0.121	0.106	0.120	0.432	0.434	0.272	0.007	0.006	004.205	030.465

Appendix XII. Sample Verification Reports and Plots and Edit Form

Maryland Department of Natural Resources

Lab Sheet

Station Name	Project	Sample Date	Arrival Time	Sample Depth	Layer Code	Replicate Number	Sample Number	Sequence Number
CB5.3	MAIN	2/7/2006	10:55	0.5	S	1	4	200602070001

Sample Description :

LAB Description :

Parameters	Type	Method Code	APC Code	DL	Value	Visible	Enabled	Pseudo	Calculated
NH4	F	L01		<	0.003	<input checked="" type="checkbox"/>	<input checked="" type="checkbox"/>	<input checked="" type="checkbox"/>	<input type="checkbox"/>
NO2	F	L01			0.0063	<input checked="" type="checkbox"/>	<input checked="" type="checkbox"/>	<input type="checkbox"/>	<input type="checkbox"/>
NO23	F	L01			0.156	<input checked="" type="checkbox"/>	<input checked="" type="checkbox"/>	<input type="checkbox"/>	<input type="checkbox"/>
PC	N	L01			1.14	<input checked="" type="checkbox"/>	<input checked="" type="checkbox"/>	<input type="checkbox"/>	<input type="checkbox"/>
PN	N	L01			0.18	<input checked="" type="checkbox"/>	<input checked="" type="checkbox"/>	<input type="checkbox"/>	<input type="checkbox"/>
PO4	F	L01			0.002	<input checked="" type="checkbox"/>	<input checked="" type="checkbox"/>	<input type="checkbox"/>	<input type="checkbox"/>
PP	N	L01			0.0099	<input checked="" type="checkbox"/>	<input checked="" type="checkbox"/>	<input type="checkbox"/>	<input type="checkbox"/>
SI	F	L01			0.4	<input checked="" type="checkbox"/>	<input checked="" type="checkbox"/>	<input type="checkbox"/>	<input type="checkbox"/>
TDN	N	L01			0.5	<input checked="" type="checkbox"/>	<input checked="" type="checkbox"/>	<input type="checkbox"/>	<input type="checkbox"/>
TDP	N	L01			0.0086	<input checked="" type="checkbox"/>	<input checked="" type="checkbox"/>	<input type="checkbox"/>	<input type="checkbox"/>
TSS	N	L01			3.7	<input checked="" type="checkbox"/>	<input checked="" type="checkbox"/>	<input type="checkbox"/>	<input type="checkbox"/>

Actual Parameters	Type	Method Code	APC Code	DL	Value	Visible	Enabled	Pseudo	Calculated
NH4	F	L01		<	0.001	<input type="checkbox"/>	<input checked="" type="checkbox"/>	<input type="checkbox"/>	<input type="checkbox"/>

Tuesday, March 28, 2006 Analysis Agency DNR/TEA Analysis Officer DNR/SAB Page 1 of 58

Appendix XII. Sample Verification Reports and Plots and Edit Form

CHLA -N RESULTS FOR CRUISE 200602A Chesapeake Bay Sampling Event

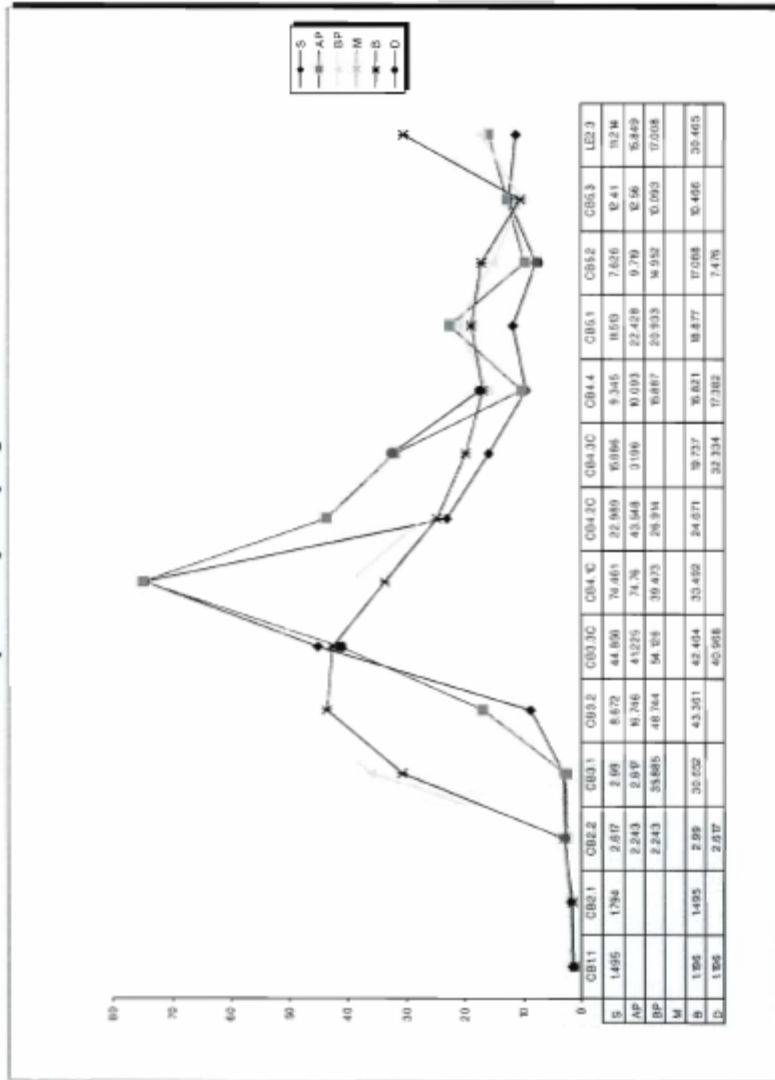

WQ Plot System v1.0 Written By Tyrone W. Lee
(c) 2002 DNR/TEA

Appendix XII. Sample Verification Reports and Plots and Edit Form

DO_N RESULTS FOR CRUISE 200602A
Chesapeake Bay Sampling Event

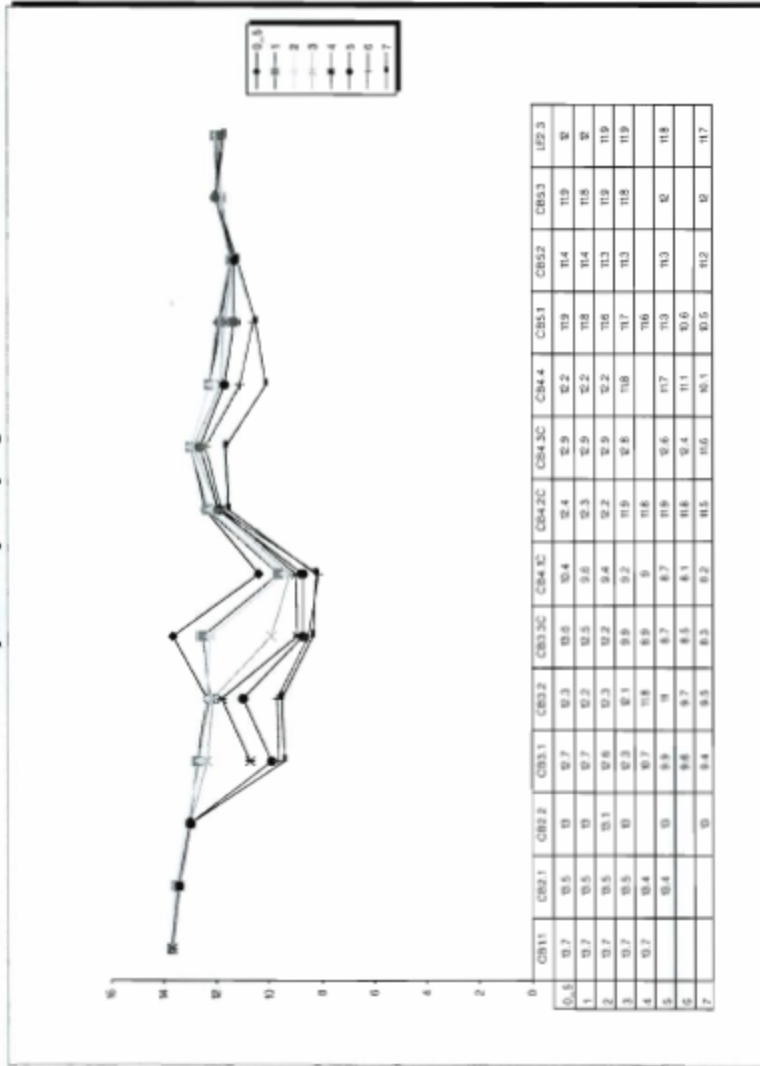

WQ Plot System v1.0 Written By Tyrone W. Lee
© 2002 DNR/TEA

Appendix XII. Sample Verification Reports and Plots and Edit Form

NH4_F RESULTS FOR CRUISE 200602A
Chesapeake Bay Sampling Event

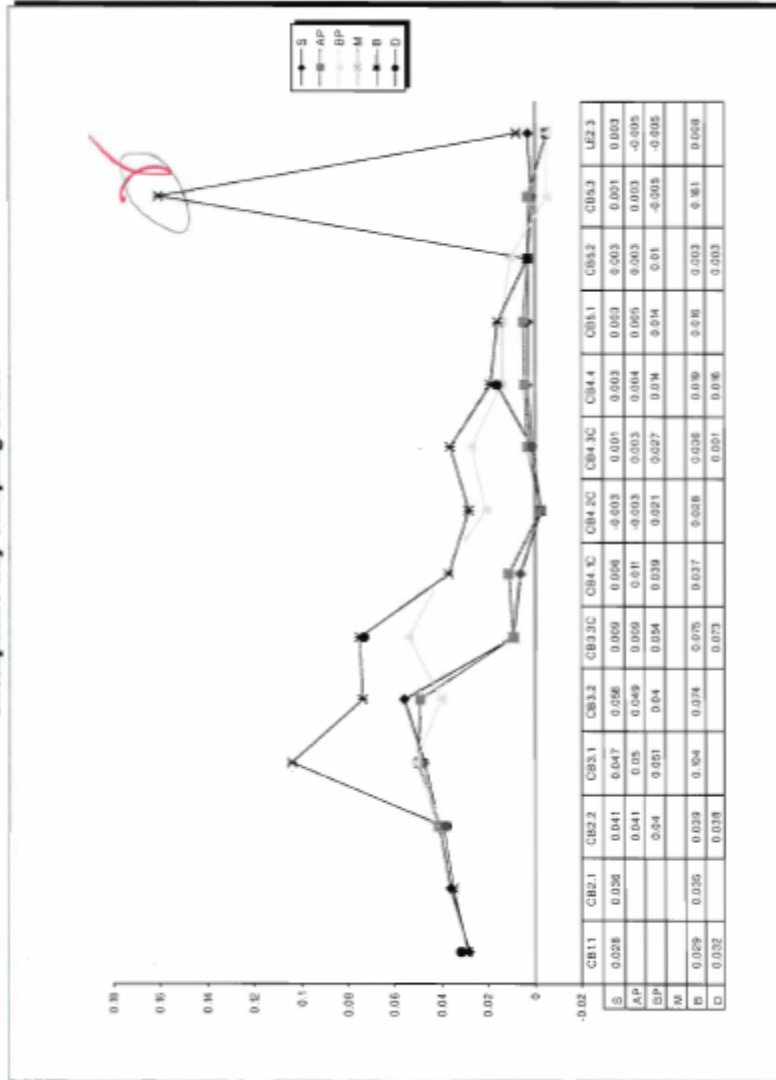

WQ Plot System v1.0 Written By Tyrone W. Lee
(c) 2002 DNR/TEA

Appendix XII. Sample Verification Reports and Plots and Edit Form

Field Seq No	Stationname	Project Code	SampleDate	Depth	Layer	Rep. No	Parameter	Value	Lower DL	Upper DL	EQ_NUM
0600206	CB4-3C	MAIN	200602A	0.5	S	1	WTEMP	5.7 ✓	-0.5	1	EQ_NUM
0600207	CB4-2C	MAIN	200602A	1	M	1	WTEMP	5.7 ✓	-0.5	1	EQ_NUM
0600208	CB4-1C	MAIN	200602A	2	M	1	WTEMP	5.7 ✓	-0.5	1	EQ_NUM
0600209	CB3-3C	MAIN	200602A	3	M	1	WTEMP	5.7 ✓	-0.5	1	EQ_NUM
0600210	CB3-2	MAIN	200602A	5	M	1	WTEMP	5.6 ✓	-0.5	1	EQ_NUM
0600211	CB3-1	MAIN	200602A	7	M	1	WTEMP	5.6 ✓	-0.5	1	EQ_NUM
0600212	CB2-2	MAIN	200602A	9	AP	1	WTEMP	5.6 ✓	-0.5	1	EQ_NUM
0600213	CB2-1	MAIN	200602A	10	M	1	WTEMP	5.6 ✓	-0.5	1	EQ_NUM
0600214	CB1-1	MAIN	200602A	11	M	1	WTEMP	5.8 ✓	-0.5	1	EQ_NUM
0600201	CB5.3	MAIN	27/2006	11	M	1	WTEMP	5.9 ✓	-0.5	1	EQ_NUM
0600202	CB5.3	MAIN	27/2006	12	M	1	WTEMP	5.9 ✓	-0.5	1	EQ_NUM
0600203	CB5.3	MAIN	27/2006	13	M	1	WTEMP	5.9 ✓	-0.5	1	EQ_NUM
0600204	CB5.3	MAIN	27/2006	14	M	1	WTEMP	5.9 ✓	-0.5	1	EQ_NUM
0600205	CB5.3	MAIN	27/2006	15	M	1	WTEMP	5.9 ✓	-0.5	1	EQ_NUM
0600206	CB5.3	MAIN	27/2006	16	M	1	WTEMP	5.9 ✓	-0.5	1	EQ_NUM
0600207	CB5.3	MAIN	27/2006	17	M	1	WTEMP	5.9 ✓	-0.5	1	EQ_NUM
0600208	CB5.3	MAIN	27/2006	18	M	1	WTEMP	6 ✓	-0.5	1	EQ_NUM
0600209	CB5.3	MAIN	27/2006	19	BP	1	WTEMP	6 ✓	-0.5	1	EQ_NUM
0600210	CB5.3	MAIN	27/2006	21	M	1	WTEMP	6.1 ✓	-0.5	1	EQ_NUM
0600211	CB5.3	MAIN	27/2006	23	M	1	WTEMP	6.1 ✓	-0.5	1	EQ_NUM

Column Check: Parameter Values are falling outside of a reasonable range

Appendix XII. Sample Verification Reports and Plots and Edit Form

Column Check: Parameter/APCodes might not appropriate and need to verify

CHI Seq No	StationName	Project Code	Cruise Name	SampleDate	Depth	Layer	Rep. #	Parameter	Value	Problem
3-460B	CB4_3C	MAIN	200602A	2/8/2006	13	BP	1	CHLA	0	A
3-460B	CB4_3C	MAIN	200602A	2/8/2006	13	BP	1	EXVOL_ML	14	A
3-460B	CB4_3C	MAIN	200602A	2/8/2006	13	BP	1	LIPAT_CM	5	A
3-460B	CB4_3C	MAIN	200602A	2/8/2006	13	BP	1	OD603B	0.127	A
3-460B	CB4_3C	MAIN	200602A	2/8/2006	13	BP	1	OD645B	0.107	A
3-460B	CB4_3C	MAIN	200602A	2/8/2006	13	BP	1	OD647B	0.121	A
3-460B	CB4_3C	MAIN	200602A	2/8/2006	13	BP	1	OD663B	0.437	A

Appendix XII. Sample Verification Reports and Plots and Edit Form

2005 CMON – May

Field (see changes written on sheets)

- Sequence Number: RHO0521 (Page 68 of 79)
- No Plots For:
 - Cruise D – Eastern Shore: EPAR_S_N
 - Cruise D – Potomac River: EPARU_Z_N
 - Cruise D – RWS: SALINITY_N
 - Cruise D – Western Shore: SALINITY_N
 - Cruise D – Western Shore: SALINITY_FLD_N

Laboratory (see changes written on sheets)

- Sequence Number: 200505100832 (Page 29 of 83)
- Sequence Number: 200505170852 (Page 45 of 83)
- Sequence Number: 200505240100 (Page 59 of 83)
- Sequence Number: 200505240101 (Page 60 of 83)
- Sequence Number: 200505240102 (Page 61 of 83)
- Sequence Number: 200505310103 (Page 77 of 83)

APPENDIX XIII

CHESAPEAKE BAY MONITORING PROGRAM PROCEDURE MODIFICATION TRACKING FORM

PMTF # _____

APPROVED DENIED

This form is used to request approval for modifications and to document approved modifications made to Chesapeake Bay Program Office procedures or methods. It is not a substitute for timely contact with the CBPO Quality Assurance Officer or his/her designee, who may be reached at 1-800-968-7229. A detailed method description including the proposed modification must be attached to this form prior to submittal to CBPO.

DATE SUBMITTED		DATE APPROVED	
REQUESTOR NAME		ORGANIZATION	
NEWLY PROPOSED [] MODIFICATION	FIELD-APPROVED [] MODIFICATION	APPROVED BY: DATE:	
TYPE OF PROCEDURE / METHOD	SAMPLING [] FIELD [] MEASUREMENT	ANALYTICAL [] OTHER [] SPECIFY:	REPORTING []
DURATION	PERMANENT [] TEMPORARY []	EFFECTIVE DATE: START DATE: END DATE:	
PROCEDURE/METHOD DESCRIPTION			
MODIFICATION DESCRIPTION			
JUSTIFICATION FOR MODIFICATION			
ANALYTICAL PARAMETERS THAT MAY BE AFFECTED BY THIS CHANGE			
AFFECTED QA PLAN(S) (TITLE, REVISION, & DATE)			
AFFECTED CRUISE(S)			
PMTF COMPLETED BY	NAME:	DATE:	

STATE APPROVAL: NAME _____ TITLE _____

SIGNATURE _____ DATE _____

CBPO APPROVAL: NAME _____ TITLE _____

SIGNATURE _____ DATE _____

APPENDIX XIV

MARYLAND DEPARTMENT OF NATURAL RESOURCES CHESAPEAKE BAY WATER QUALITY MONITORING PROGRAM

Log of Significant Changes

Date Initiated	Procedural Changes
See Tables 1, 2, 3 and 4 following the Log	<p>NOTE Changes in Measured Parameters and in Detection Limits are detailed in the following tables:</p> <ul style="list-style-type: none">• Table 1 - Tributary Detection Limit• Table 2 - Patuxent Detection Limits• Table 3 - Potomac Detection Limits• Table 4 - LE2.3 and Mainstem Detection Limits.
March 1, 1985	The EPA Central Regional Laboratory (CRL) in Annapolis processed Mainstem cruises water quality samples collected in July-December of 1984. CRL processed most Mainstem samples in 1985 and 1986. However the beginning 1-Mar-1985 Chesapeake Biological Laboratory began analysis of dissolved constituents (Si, DOC, TDN and TDP). In May of 1987 water quality lab work was switched to Chesapeake Biological Laboratory
May 1, 1987	
April 1, 1989	Dropped Patuxent River station XCG8613
July 1, 1990	Nutrient analysis of Patuxent River samples switched from State lab at Department of Health and Mental Hygiene (DHMH) to University of Maryland Chesapeake Biological Laboratory
October 1, 1990	Switch to filtering samples for PO ₄ , NH ₄ , NO ₃ , NO ₂ in Potomac instead of analyzing whole water sample
December 10, 1990	A data quality assurance issue titled “Adjusting Maryland Department of Health and Mental Hygiene (MDHMH) total phosphorus (TP) and total dissolved phosphorus (TDP) data,” was entered into the Data Analysis Issues Tracking System 10-Dec-1990. MDHMH was not using calibration data or blank data in calculating TP and TDP from 1984 through 1989. Most of the data affected by this problem were re-calibrated and re-submitted to the Chesapeake Bay Program. Samples analyzed in 1984 were not re-calculated. Some samples analyzed between 1985 and 1990 were also not re-calibrated due to missing blank data and other problems. As a result, there may be a mix of uncorrected and corrected TP and TDP data in the data base.

Date Initiated	Procedural Changes
January 28, 1992	A report titled “Adjusting helix Kjeldahl nitrogen results: Maryland Chesapeake Bay mainstem water quality monitoring program, 1984-1985” was produced by Computer Sciences Corporation under contract to the U.S. Environmental Protection Agency, contract number 68-WO-0043. The report examined the effects of helix digestion on Kjeldahl nitrogen, which is biased low relative to other digestion methods, and presented the equations used to adjust 1984 and 1985 data. The report was approved by Chesapeake Bay Program Analytical Methods and Quality Assurance Workgroup 12-Nov-1991 and by the Chesapeake Bay Program Monitoring Subcommittee 22-Jan-1992.
January 1996	TOC and DOC was dropped from Mainstem sampling
May 1, 1998	Nutrient analysis of Potomac and Minor Tributary samples switched from State lab at Department of Health and Mental Hygiene (DHMH) to University of Maryland Chesapeake Biological Laboratory
March 2003	Addition of ten new long-term stations previously part of the <i>Pfiesteria</i> special project sampling BXK0031, CCM0069, MNK0146, POK0087, TRQ0088, TRQ0146, WIW0141, XAK7810, XCI4078, XDJ9007
July 1, 2005	Sampling TF1.0 on the Patuxent was dropped from the CORE/Trend program, which had samples analyzed at DHMH. The station is now sampled only under the Patuxent tributary program, which has samples analyzed at CBL
January 2007	Starting in July, 2007, silica (SIF) will no longer be collected at any of the mainstem stations during the months of July-December, and will only be collected from the surface layer at the five mainstem stations that correspond with phytoplankton program sampling (CB1.1, CB2.2, CB3.3C, CB4.3C and CB5.2) in the months January-June. Tributary collection of silica samples will also change, beginning July, 2007, as follows: no samples July-December, and silica only from surface sample at the following stations January-June: TF2.3, RET2.2, LE2.2, TF1.5, TF1.7, LE1.1, ET5.1, WT5.1.
January 2009	Beginning in January 2009, chlorophyll analysis by the Maryland Department of Health and Mental Hygiene ceased and the Chesapeake Bay Laboratory, Nutrient Analytical Services Laboratory began analyzing chlorophyll samples.

Date Initiated	Procedural Changes
January 2009	NO ₂ detection limit change: was 0.0006 mg/L, updated to 0.0001 mg/L
January 2009	NH ₄ detection limit change: was 0.003 mg/L updated to 0.006 mg/L
February 2009	<p data-bbox="516 487 1354 705">Beginning in February 2009, YSI Series 6820 instruments were added to the field instrument inventory. YSI instruments are equipped with an optical dissolved oxygen sensor (ROX) instead of the Standard Clark Polarographic Sensor. Temperature, pH, specific conductance and depth sensors perform similarly to respective Hydrolab sensors.</p> <p data-bbox="516 743 1354 848">Both the Hydrolab and YSI optical dissolved oxygen sensors use similar luminescent technology and phase shift techniques to measure dissolved oxygen.</p> <p data-bbox="516 886 1354 995">Mainstem and Patuxent River cruises will exclusively use YSI instead of Hydrolab instruments. All tributary sampling activities will use either Hydrolab or YSI instruments.</p>
January 2010	<p data-bbox="516 1033 1377 1138">Mainstem stations: CB3.3 E CB3.3W, CB4.1E, CB4.1W, CB4.2E, CB4.2W, CB4.3E, CB4.3W will be sampled 10 times per year instead of 12 times per year.</p> <p data-bbox="516 1176 1354 1323">Patuxent River stations: CB5.1W, LE1.1, LE1.2, LE1.3, LE1.4, RET1.1, TF1.0, TF1.2, TF1.3, TF1.4, TF1.5, TF1.6, TF1.7 and WXT0001 will be sampled 12 times per year instead of 20 times per year.</p> <p data-bbox="516 1360 1370 1579">Potomac River stations: LE2.2, MAT0016, MAT0078, PIS0033, RET2.1, RET2.2, RET2.4, TF2.1, TF2.2, TF2.3, TF2.4 and XFB1986 will be sampled 12 times per year instead of 20 times per year. Potomac River station: LE2.3, which is sampled on Mainstem cruises, will be sampled 12 times per year instead of 20 times per year.</p> <p data-bbox="516 1617 1338 1724">Chester River stations: ET4.1 and ET4.2 and Choptank River stations: ET5.1 and ET5.2 and station WT4.1 in the Back River will be sampled 12 times per year instead of 16 times per year.</p>

Tributary Detection Limits														
Censor is to 1/2 DL														
Calculated Values														
Tributary needs water year censored dataset because some stations not start until 1986, and Oct 86 DL different than Oct 85 DL														
parameter	1/1/85-5/31/86	6/1/86-12/31/88	1/1/89-4/30/90	5/1/90-6/30/94	7/1/94-7/11/95	7/12/95-4/30/98	5/1/98-12/31/99	1/1/00-12/31/03	1/1/04-12/31/05	1/1/06-12/31/06	1/1/07-12/31/07	1/1/08-12/31/08	1/1/09-12/31/09	1/1/10-12/31/10
parameter	DHMH	DHMH	DHMH	DHMH	DHMH	DHMH	CBL	CBL	CBL	CBL	CBL	CBL	CBL	CBL
CHLA	DHMH did Chlorophylls until December 2008; no DL were determined											0.62*	0.62*	
DIN	0.04	0.028	0.028	0.028	0.028	0.01	0.0032	0.0037	0.0037	0.0037	0.0037	0.0037	0.0067	0.0067
DOC	1	1	0.8	0.5	0.5	0.5	0.24	0.24	0.15	0.15	0.24	0.24	0.24	0.24
DON	0.08	0.092	0.092	0.092	0.092	0.092	0.0168	0.0163	0.0163	0.0163	0.0163	0.0463	0.0433	0.0433
DOP	0	0.006	0.006	0.006	0.006	0.006	0.0004	0.0004	0.0004	0.0009	0.0009	0.0009	0.0009	0.0009
NH4	0.02	0.008	0.008	0.008	0.008	0.008	0.003	0.003	0.003	0.003	0.003	0.003	0.006	0.006
NO2	0.002	0.002	0.002	0.002	0.002	0.002	0.0002	0.0002	0.0002	0.0002	0.0006	0.0006	0.0001	0.0006
NO23	0.02	0.02	0.02	0.02	0.02	0.02	0.0002	0.0007	0.0007	0.0007	0.0007	0.0007	0.0007	0.0007
PC	0	0	0	0	0	0	0.0633	0.0633	0.0633	0.0759	0.0633	0.0633	0.0633	0.0633
PHEO	DHMH did Pheopigments until December 2008; no DL were determined											0.74	0.74	
PN	0	0	0	0	0	0	0.0105	0.0105	0.0105	0.0105	0.0105	0.0105	0.0105	0.0105
PO4	0.01	0.004	0.004	0.004	0.004	0.004	0.0006	0.0006	0.0006	0.0006	0.0006	0.0006	0.0006	0.0006
PP	0	0	0	0	0	0	0.0012	0.0024	0.0024	0.0024	0.0054	0.0021	0.0021	0.0021
SI	0.1	0.1	0.1	0.1	0.1	0.1	0.01	0.01	0.01	0.01	0.08	0.01	0.01	0.01
TDN	0.08	0.12	0.12	0.12	0.12	0.102	0.02	0.02	0.02	0.02	0.02	0.05	0.05	0.05
TDP	0.01	0.01	0.01	0.01	0.01	0.01	0.001	0.001	0.001	0.0015	0.0015	0.0015	0.0015	0.0015
TKNF	0.1	0.1	0.1	0.1	0.1	0.1								
TKNW	0.1	0.1	0.1	0.1	0.1	0.1								
TN	0.12	0.12	0.12	0.12	0.12	0.102	0.0305	0.0305	0.0305	0.0305	0.0305	0.0605	0.0605	0.0605
TOC	1	1	0.8	0.5	0.5	0.5	0.3033	0.3033	0.2133	0.2259	0.3033	0.3033	0.3033	0.3033
TON	0.08	0.092	0.092	0.092	0.092	0.092	0.0273	0.0268	0.0268	0.0268	0.0268	0.0568	0.0538	0.0538
TOP	0	0.006	0.006	0.006	0.006	0.006	0.0016	0.0028	0.0028	0.0033	0.0063	0.003	0.003	0.003
TP	0.01	0.01	0.01	0.01	0.01	0.01	0.0022	0.0034	0.0034	0.0039	0.0069	0.0036	0.0036	0.0036
TSS	1	1	1	1	1	1	1.5	2.4	2.4	2.4	2.4	2.4	2.4	2.4
VSS										0.9	0.9	0.9	0.9	0.9

* Bay Program trends program sets Chla detection limit to 1 ug/L

Table 1 Tributary Detection Limits

Patuxent Detection Limits

Censor is to 1/2 DL

Calculated Values

Patuxent doesn't need Water year censored datasets because all stations started in early 1985

parameter	DHMH	DHMH	DHMH	DHMH	CBL	CBL	CBL	CBL	CBL	CBL	CBL	CBL
	1/1/85-5/31/86	6/1/86-12/31/88	1/1/89-4/30/90	5/1/90-6/30/90	7/1/90-12/31/99	1/1/00-12/31/03	1/1/04-12/31/05	1/1/06-12/31/06	1/1/07-12/31/07	1/1/08-12/31/08	1/1/09-12/31/09	1/1/10-12/31/10
CHLA	DHMH did Chlorophylls until December 2008; no DL were determined										0.62*	0.62*
DIN	0.04	0.028	0.028	0.028	0.0032	0.0037	0.0037	0.0037	0.0037	0.004	0.007	0.01
DOC	1	1	0.8	0.5	0.24	0.24	0.15	0.15	0.24	0.24	0.24	0.24
DON	0.08	0.092	0.092	0.092	0.0168	0.0163	0.0163	0.0163	0.0163	0.046	0.043	0.04
DOP	0	0.006	0.006	0.006	0.0004	0.0004	0.0004	0.0009	0.0009	9E-04	9E-04	0
NH4	0.02	0.008	0.008	0.008	0.003	0.003	0.003	0.003	0.003	0.003	0.006	0.01
NO2	0.002	0.002	0.002	0.002	0.0002	0.0002	0.0002	0.0002	0.0002	0.0006	6E-04	1E-04
NO23	0.02	0.02	0.02	0.02	0.0002	0.0007	0.0007	0.0007	0.0007	7E-04	7E-04	0
PC	0	0	0	0	0.0633	0.0633	0.0633	0.0759	0.0633	0.063	0.063	0.06
PHEO	DHMH did Pheopigments until December 2008; no DL were determined										0.74	0.74
PN	0	0	0	0	0.0105	0.0105	0.0105	0.0105	0.0105	0.011	0.011	0.01
PO4	0.01	0.004	0.004	0.004	0.0006	0.0006	0.0006	0.0006	0.0006	6E-04	6E-04	0
PP	0	0	0	0	0.0012	0.0024	0.0024	0.0024	0.0054	0.002	0.002	0
SI	0.1	0.1	0.1	0.1	0.01	0.01	0.01	0.01	0.08	0.01	0.01	0.01
TDN	0.08	0.12	0.12	0.12	0.02	0.02	0.02	0.02	0.02	0.05	0.05	0.05
TDP	0.01	0.01	0.01	0.01	0.001	0.001	0.001	0.0015	0.0015	0.002	0.002	0
TKNF	0.1	0.1	0.1	0.1								
TKNW	0.1	0.1	0.1	0.1								
TN	0.12	0.12	0.12	0.12	0.0305	0.0305	0.0305	0.0305	0.0305	0.061	0.061	0.06
TOC	1	1	0.8	0.5	0.3033	0.3033	0.2133	0.2259	0.3033	0.303	0.303	0.3
TON	0.08	0.092	0.092	0.092	0.0273	0.0268	0.0268	0.0268	0.0268	0.057	0.054	0.05
TOP	0	0.006	0.006	0.006	0.0016	0.0028	0.0028	0.0033	0.0063	0.003	0.003	0
TP	0.01	0.01	0.01	0.01	0.0022	0.0034	0.0034	0.0039	0.0069	0.004	0.004	0
TSS	1	1	1	1	1.5	2.4	2.4	2.4	2.4	2.4	2.4	2.4
VSS								0.9	0.9	0.9	0.9	0.9

* Bay Program trends program sets Chla detection limit to 1 ug/L

Table 2 Patuxent Detection Limits

Potomac doesn't need Water year censored datasets because all stations started in early 1985 EXCEPT LE2.3 because uses CBL detection limits!
PO4 prior to 10/90 is not used in trends

parameter	DHMH	DHMH	DHMH	DHMH	DHMH	DHMH	CBL	CBL	CBL	CBL	CBL	CBL	CBL	CBL
	1/1/85-5/31/86	6/1/86-12/31/88	1/1/89-4/30/90	5/1/90-6/30/94	7/1/94-7/11/95	7/12/95-4/30/98	5/1/98-12/31/99	1/1/00-12/31/03	1/1/04-12/31/05	1/1/06-12/31/06	1/1/07-12/31/07	1/1/08-12/31/08	1/1/09-12/31/09	1/1/10-12/31/10
CHLA	DHMH did Chlorophylls until December 2008; no DL were determined												0.62*	0.62*
DIN	0.04	0.028	0.028	0.028	0.028	0.01	0.0032	0.0037	0.0037	0.0037	0.0037	0.0037	0.0067	0.0067
DOC	1	1	0.8	0.5	0.5	0.5	0.24	0.24	0.15	0.15	0.24	0.24	0.24	0.24
DON	0.08	0.092	0.092	0.092	0.092	0.092	0.0168	0.0163	0.0163	0.0163	0.0163	0.0463	0.0433	0.0433
DOP	0	0.006	0.006	0.006	0.006	0.006	0.0004	0.0004	0.0004	0.0009	0.0009	0.0009	0.0009	0.0009
NH4	0.02	0.008	0.008	0.008	0.008	0.008	0.003	0.003	0.003	0.003	0.003	0.003	0.006	0.006
NO2	0.002	0.002	0.002	0.002	0.002	0.002	0.0002	0.0002	0.0002	0.0002	0.0006	0.0006	0.0001	0.0001
NO23	0.02	0.02	0.02	0.02	0.02	0.002	0.0002	0.0007	0.0007	0.0007	0.0007	0.0007	0.0007	0.0007
PC	0	0	0	0	0	0	0.0633	0.0633	0.0633	0.0759	0.0633	0.0633	0.0633	0.0633
PHEO	DHMH did Pheopigments until December 2008; no DL were determined												0.74	0.74
PN	0	0	0	0	0	0	0.0105	0.0105	0.0105	0.0105	0.0105	0.0105	0.0105	0.0105
PO4	0.01	0.004	0.004	0.004	0.004	0.004	0.0006	0.0006	0.0006	0.0006	0.0006	0.0006	0.0006	0.0006
PP	0	0	0	0	0	0	0.0012	0.0024	0.0024	0.0024	0.0054	0.0021	0.0021	0.0021
SI	0.1	0.1	0.1	0.1	0.1	0.1	0.01	0.01	0.01	0.01	0.08	0.01	0.01	0.01
TDN	0.08	0.12	0.12	0.12	0.12	0.102	0.02	0.02	0.02	0.02	0.02	0.05	0.05	0.05
TDP	0.01	0.01	0.01	0.01	0.01	0.01	0.001	0.001	0.001	0.0015	0.0015	0.0015	0.0015	0.0015
TKNF	0.1	0.1	0.1	0.1	0.1	0.1								
TKNW	0.1	0.1	0.1	0.1	0.1	0.1								
TN	0.12	0.12	0.12	0.12	0.12	0.102	0.0305	0.0305	0.0305	0.0305	0.0305	0.0605	0.0605	0.0605
TOC	1	1	0.8	0.5	0.5	0.5	0.3033	0.3033	0.2133	0.2259	0.3033	0.3033	0.3033	0.3033
TON	0.08	0.092	0.092	0.092	0.092	0.092	0.0273	0.0268	0.0268	0.0268	0.0268	0.0568	0.0538	0.0538
TOP	0	0.006	0.006	0.006	0.006	0.006	0.0016	0.0028	0.0028	0.0033	0.0063	0.003	0.003	0.003
TP	0.01	0.01	0.01	0.01	0.01	0.01	0.0022	0.0034	0.0034	0.0039	0.0069	0.0036	0.0036	0.0036
TSS	1	1	1	1	1	1	1.5	2.4	2.4	2.4	2.4	2.4	2.4	2.4
VSS										0.9	0.9	0.9	0.9	0.9

* Bay Program trends program sets Chla detection limit to 1 ug/L

Table 3 Potomac Detection Limits

LE2.3 and Mainstem Detection Limits														
Censor is to 1/2 DL														
Calculated Values														
	CBL	CBL	CBL	CBL	CBL	CBL	CBL	CBL	CBL	CBL	CBL	CBL	CBL	CBL
parameter	1/1/85-2/28/85	3/1/85-5/15/85	5/16/85-9/30/86	10/1/86-9/31/87	10/1/87-9/19/88	9/20/88-12/31/89	1/1/00-12/31/03	1/1/04-12/31/05	1/1/06-12/31/06	1/1/07-12/31/07	1/1/08-12/31/08	1/1/09-12/31/09	1/1/10-12/31/10	
CHLA	DHMH did Chlorophylls until December 2008; no DL were determined											0.62*	0.62*	
DIN	0.08	0.004	0.0039	0.0039	0.0032	0.0032	0.0037	0.0037	0.0037	0.0037	0.0037	0.0067	0.0067	
DOC	1	1	0.5	0.5	0.5	0.24	0.24	0.15	0.15	0.24	0.24	0.24	0.24	
DON	0.255	0.37	0.0261	0.1952	0.0169	0.0168	0.0163	0.0163	0.0163	0.0163	0.0463	0.0433	0.0433	
DOP	0.005	0.003	0.0034	0.0104	0.0004	0.0004	0.0004	0.0004	0.0009	0.0009	0.0009	0.0009	0.0009	
NH4	0.04	0.003	0.003	0.003	0.003	0.003	0.003	0.003	0.003	0.003	0.003	0.006	0.006	
NO2	0.01	5E-04	0.0005	0.0005	0.0002	0.0002	0.0002	0.0002	0.0002	0.0006	0.0006	0.0001	0.0001	
NO23	0.04	9E-04	0.0009	0.0009	0.0002	0.0002	0.0007	0.0007	0.0007	0.0007	0.0007	0.0007	0.0007	
PC	0	0	0.001	0.5	0.001	0.0633	0.0633	0.0759	0.0633	0.0633	0.0633	0.0633	0.0633	
PHEO	DHMH did Pheopigments until December 2008; no DL were determined											0.74	0.74	
PN	0.068	0.068	0.001	0	0.001	0.0105	0.0105	0.0105	0.0105	0.0105	0.0105	0.0105	0.0105	
PO4	0.007	0.002	0.0016	0.0016	0.0006	0.0006	0.0006	0.0006	0.0006	0.0006	0.0006	0.0006	0.0006	
PP	0	0	0.0013	0	0.0012	0.0012	0.0024	0.0024	0.0024	0.0054	0.0021	0.0021	0.0021	
SI	0.1	0.012	0.012	0.012	0.01	0.01	0.01	0.01	0.01	0.08	0.01	0.01	0.01	
TDN	0.335	0.374	0.03	0.1991	0.02	0.02	0.02	0.02	0.02	0.02	0.05	0.05	0.05	
TDP	0.012	0.005	0.005	0.012	0.001	0.001	0.001	0.001	0.0015	0.0015	0.0015	0.0015	0.0015	
TKNF	0.375	0.375		0.2										
TKNW	0.443	0.443		0.2										
TN	0.483	0.444	0.031	0.2009	0.021	0.0305	0.0305	0.0305	0.0305	0.0305	0.0605	0.0605	0.0605	
TOC	1	1	0.501	1	0.501	0.3033	0.3033	0.2133	0.2259	0.3033	0.3033	0.3033	0.3033	
TON	0.403	0.44	0.0271	0.197	0.0179	0.0273	0.0268	0.0268	0.0268	0.0268	0.0568	0.0538	0.0538	
TOP	0.005	0.003	0.0047	0.0104	0.0016	0.0016	0.0028	0.0028	0.0033	0.0063	0.003	0.003	0.003	
TP	0.012	0.005	0.0063	0.012	0.0022	0.0022	0.0034	0.0034	0.0039	0.0069	0.0036	0.0036	0.0036	
TSS	4	4	1	1	1.98	1.5	2.4	2.4	2.4	2.4	2.4	2.4	2.4	
VSS						1.98	1.98	1.98	0.9	0.9	0.9	0.9	0.9	
NOTES	IN 1985 DATA, there was a salinity-related matrix problem with TKNW and TKNF analysis; Peter Bergstrom did an analysis and devised a correction factor that effects the DL; worst case DL for TKNW is 0.443 and TKNF is 0.350													

Table 4 LE2.3 and Mainstem Detection Limits

NOTE: Due to logistical considerations, sample for the Tributaries station LE2.3 are collected during Mainstem cruises.